

Contents

Child Safety P. 61

Exhaust Gas Hazard P. 79

Safety Labels P. 80

Opening and Closing the Tailgate P. 159
Operating the Switches Around the Steering Wheel P. 170
Interior Lights/Interior Convenience Items P. 202

Security System P. 162

Opening and Closing the Windows P. 166
Adjusting the Mirrors P. 190
Climate Control System* P. 215

Audio Error Messages* P. 304
Hands-Free Telephone System* P. 329, 353

General Information on the Audio System P. 308

Braking P. 430
Accessories and Modifications P. 457

Parking Your Vehicle P. 440

Rearview Camera* P. 451

Oil Monitor System* P. 468
Replacing Light Bulbs P. 514
Remote Transmitter Care P. 544

Maintenance Schedule* P. 473
Checking and Maintaining Wiper Blades P. 530
Climate Control System Maintenance P. 546

Maintenance Under the Bonnet P. 490
Cleaning P. 549

Engine Does Not Start P. 574
Fuses P. 592
Priming the Fuel System P. 603

Jump Starting P. 578
Emergency Towing P. 599

Shift Lever Does Not Move P. 582

Devices that Emit Radio Waves* P. 622

EC Declaration of Conformity Content Outline* P. 624

Quick Reference Guide P. 2

Safe Driving P. 31

Instrument Panel P. 81

Controls P. 147

Features P. 221

Driving P. 371

Maintenance P. 459

Handling the Unexpected P. 555

Information P. 607

Index P. 625

Visual Index

Left-hand Drive Type

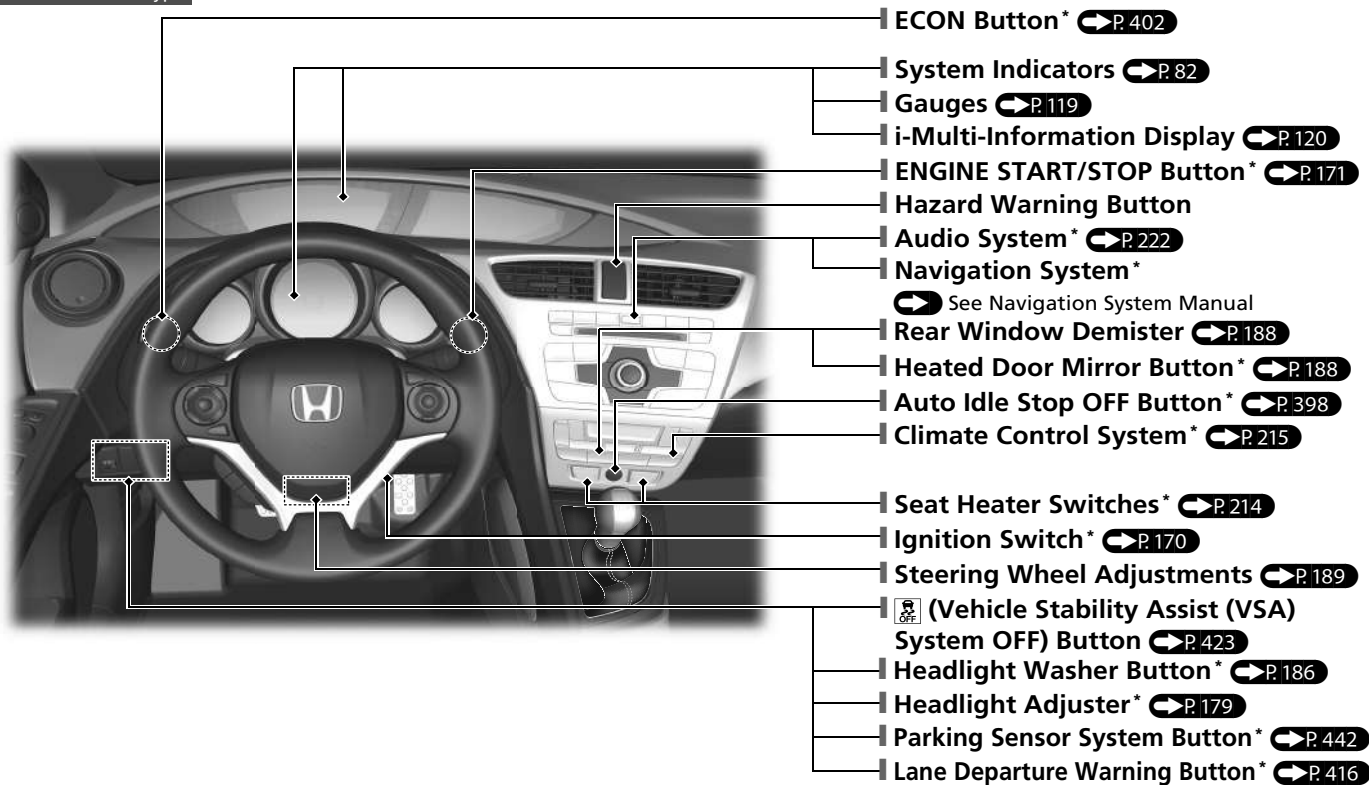

Right-hand Drive Type

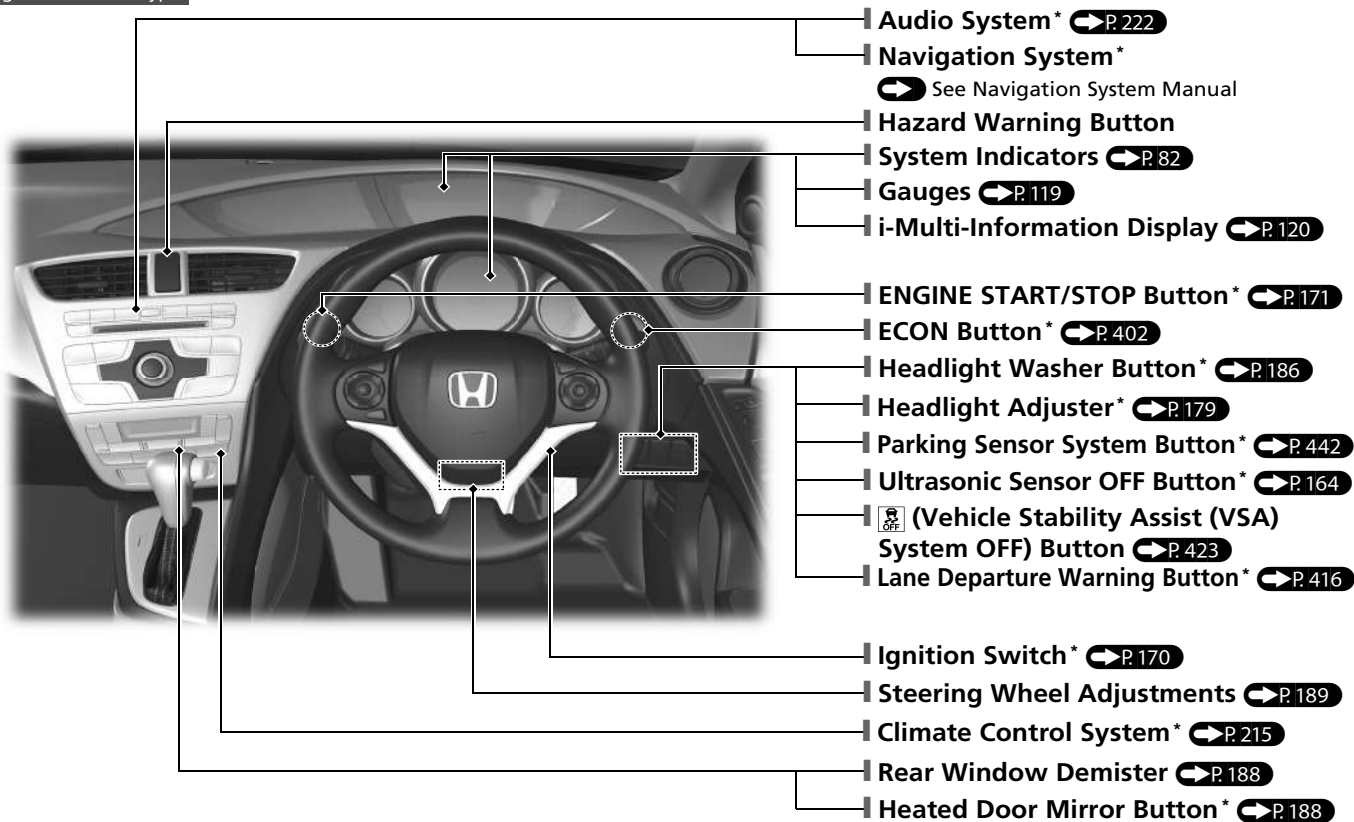

* Not available on all models

Visual Index

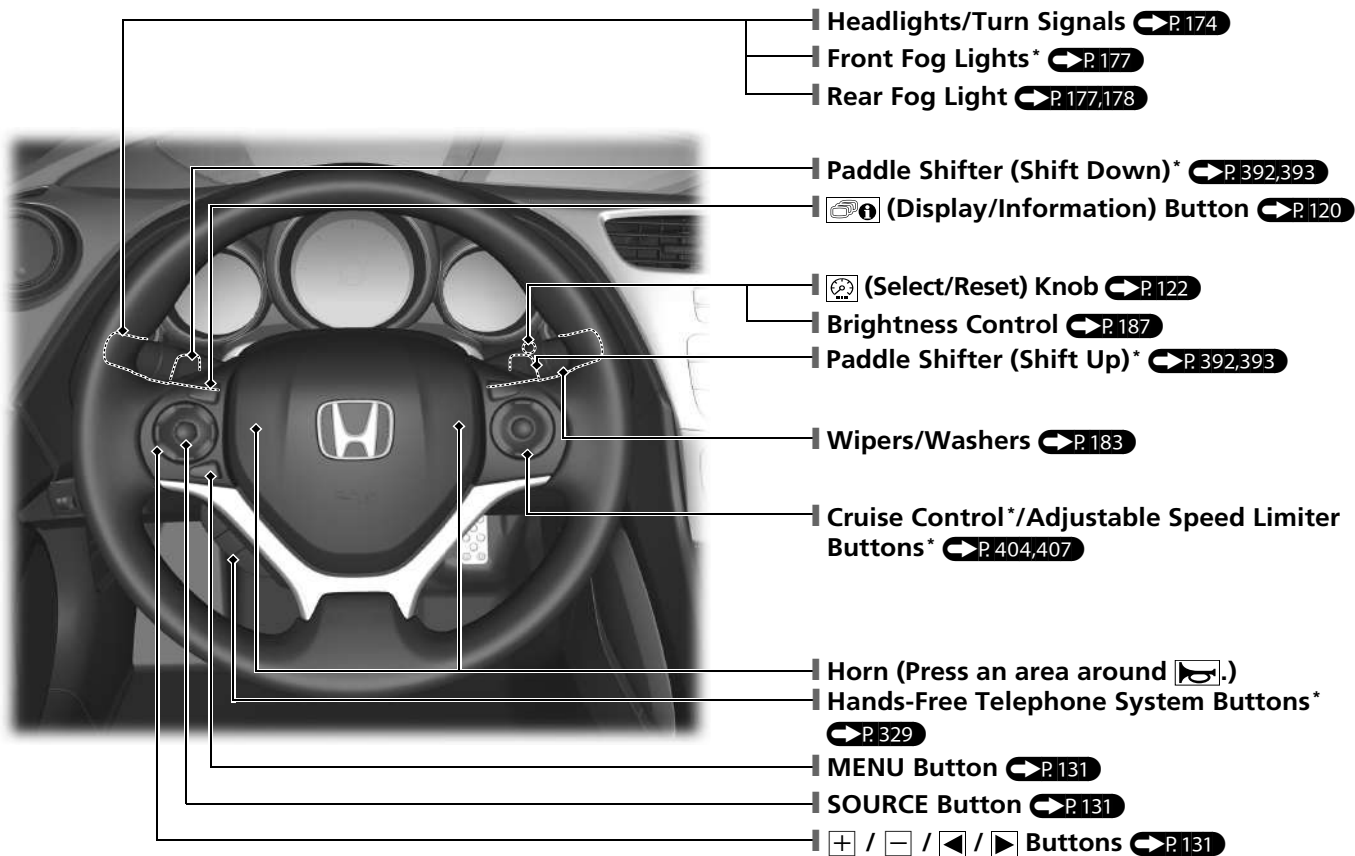

Left-hand Drive Type

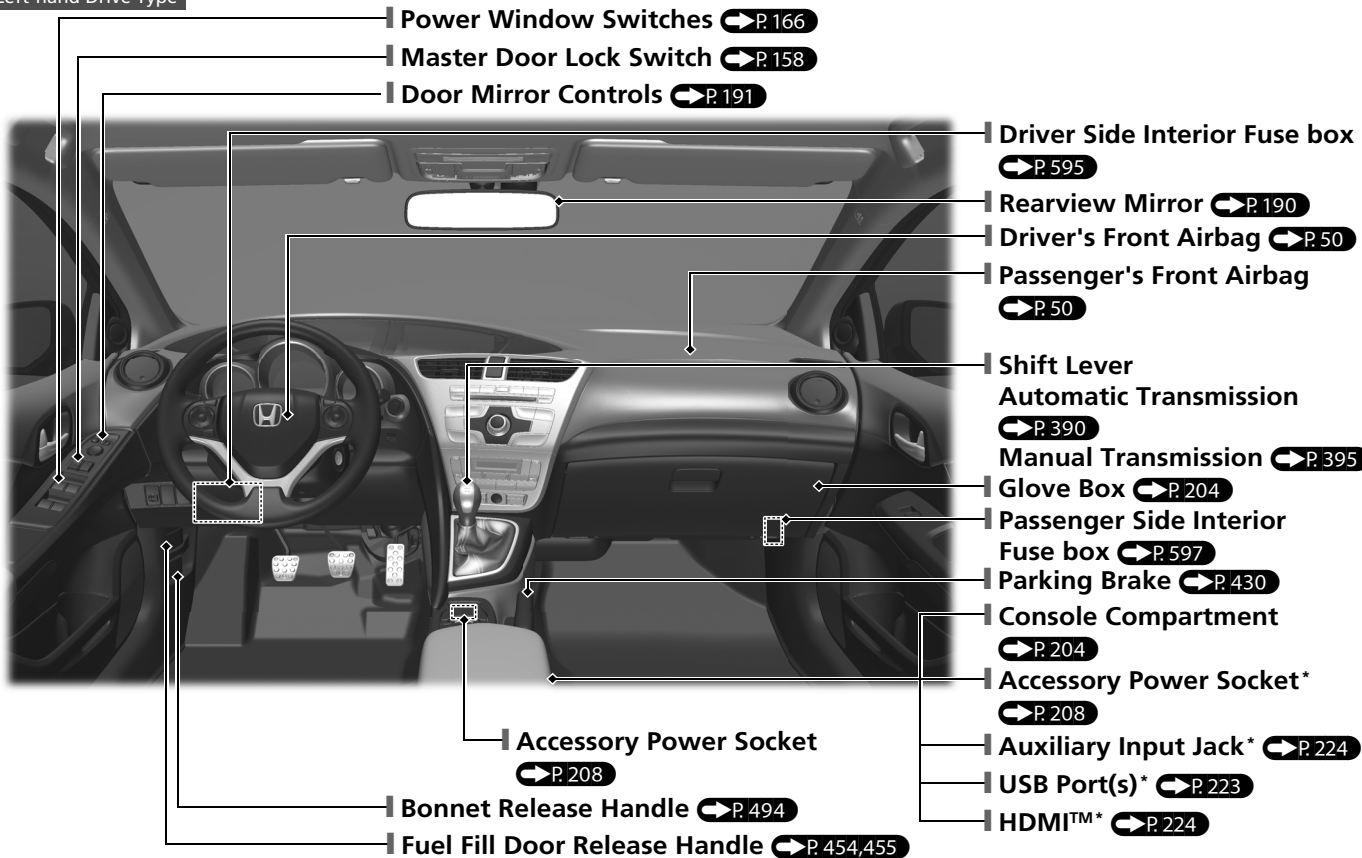

* Not available on all models

Visual Index

Right-hand Drive Type

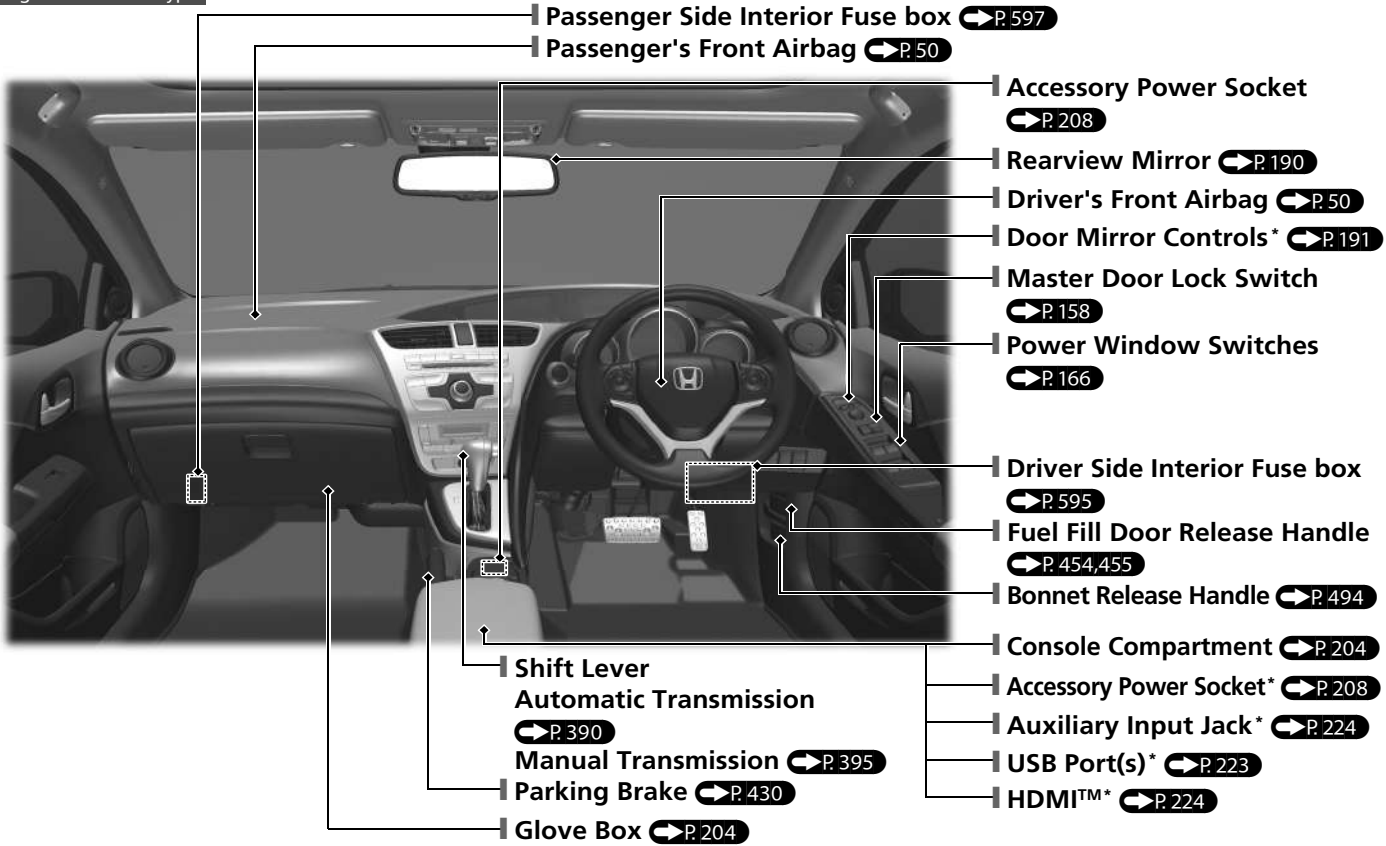

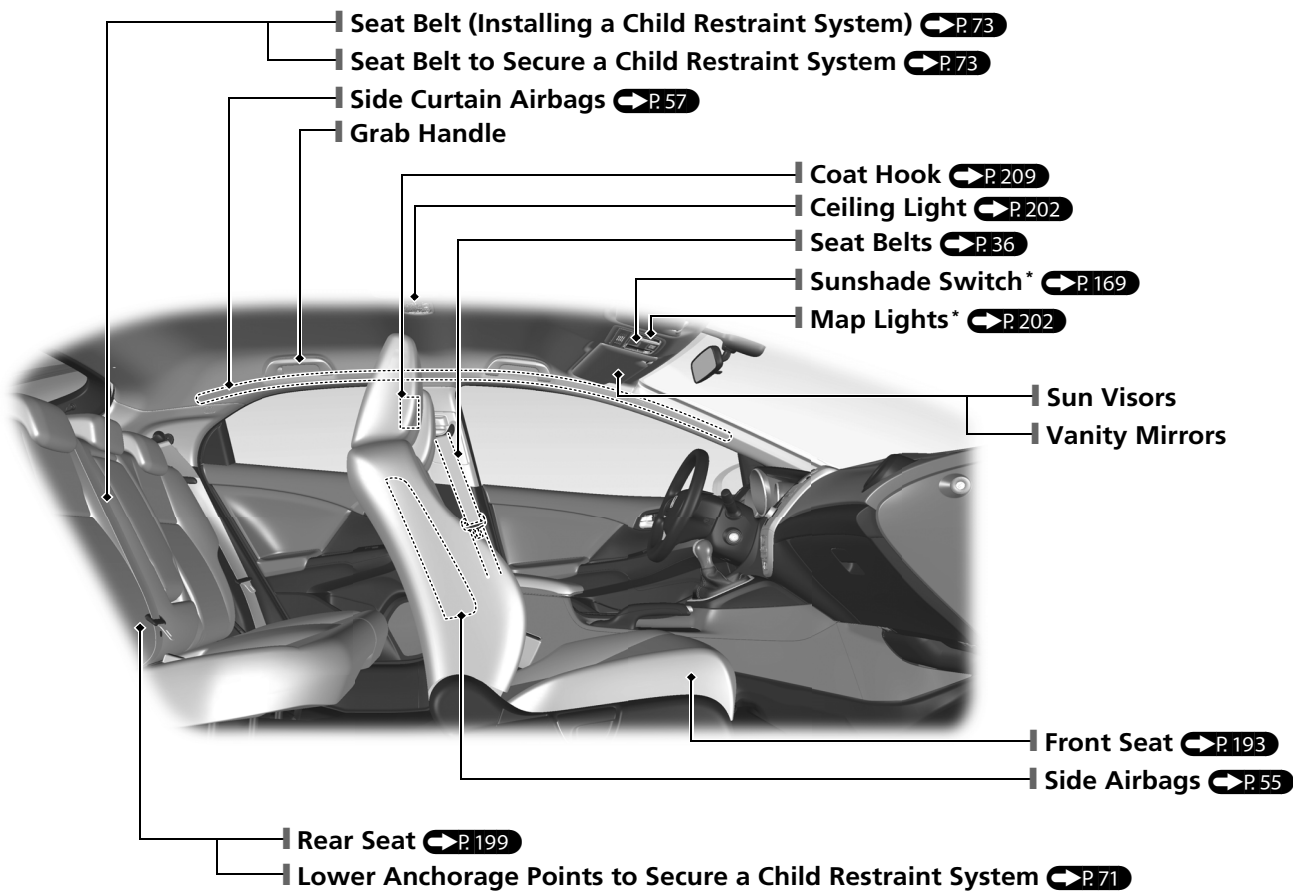

* Not available on all models

Visual Index

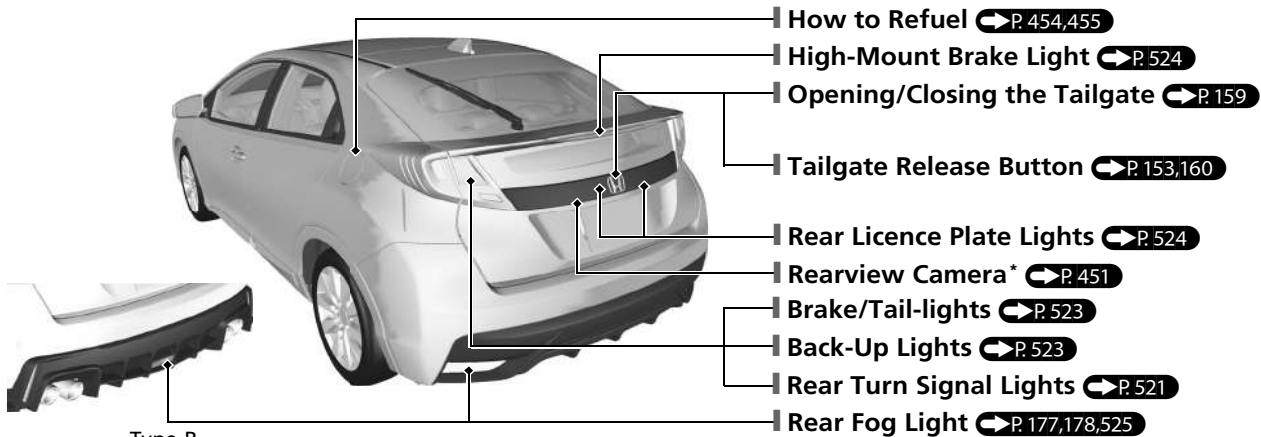
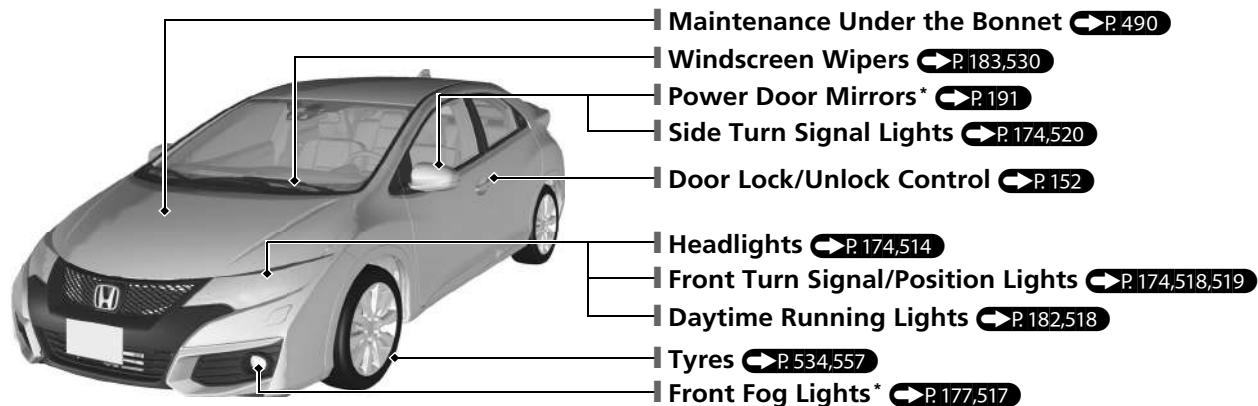

Eco Assist System*

Ambient Meter

- Changes colour to reflect your driving style when ECON mode is on.
Green: Fuel efficient driving
Blue green: Moderate acceleration/ deceleration
Blue: Aggressive acceleration/ deceleration
- The ambient meter colour changes in accordance with your brake or accelerator pedal operation.

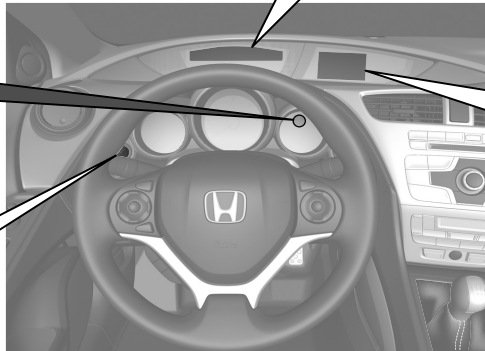

ECON Button ➔ P.402
Helps maximize fuel economy.



ECON Mode Indicator ➔ P.93
Comes on when ECON mode is on.



The message is displayed for a few seconds when ECON mode is turned on.

Auto Idle Stop Function *

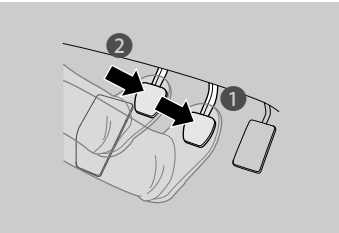
To improve fuel economy, the engine stops and then restarts as detailed below. When Auto Idle Stop is on, the Auto Idle Stop indicator (green) comes on.  P. 398

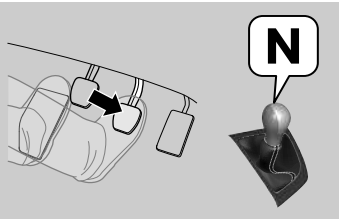
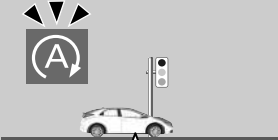
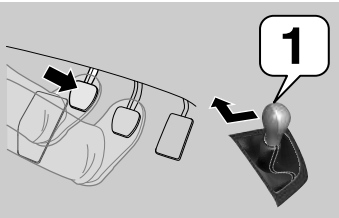
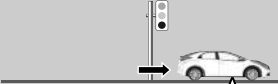
At	Manual transmission	Engine status
<p>Deceleration</p> 	<p>1. Depress the brake pedal. 2. Fully depress the clutch pedal.</p> 	 <p>On</p>
<p>Stop</p> 	<ul style="list-style-type: none"> • Continue to depress the brake pedal. • Move the shift lever to N. • Release the clutch pedal. 	 <p>Off</p>
<p>Start-up</p>	<p>1. Depress the clutch pedal again. 2. Move the shift lever to 1. 3. Depress the accelerator pedal to resume driving.</p> 	 <p>Restarting</p>

Safe Driving P.31

Airbags P.48

- Your vehicle is fitted with airbags to help to protect you and your passengers during a moderate-to-severe collision.

Child Safety P.61

- All children 12 and younger should be seated in the rear seat.
- Small children should be properly restrained in a front facing child restraint system.
- Infants must be properly restrained in a rear-facing child restraint system on a rear seat.

Exhaust Gas Hazard P.79

- Your vehicle emits dangerous exhaust gases that contain carbon monoxide. Do not run the engine in confined spaces where carbon monoxide gas can accumulate.

Seat Belts P.36

- Fasten your seat belt and sit upright well back in the seat.
- Check that your passengers are wearing their seat belts correctly.

Before Driving Checklist P.35

- Before driving, check that the front seats, head restraints, steering wheel, and mirrors have been properly adjusted.



Fasten your lap belt as low as possible.















* Not available on all models

Instrument Panel ↔ P.81

Gauges ↔ P.119 / i-Multi-Information Display ↔ P.120 / System Indicators ↔ P.82



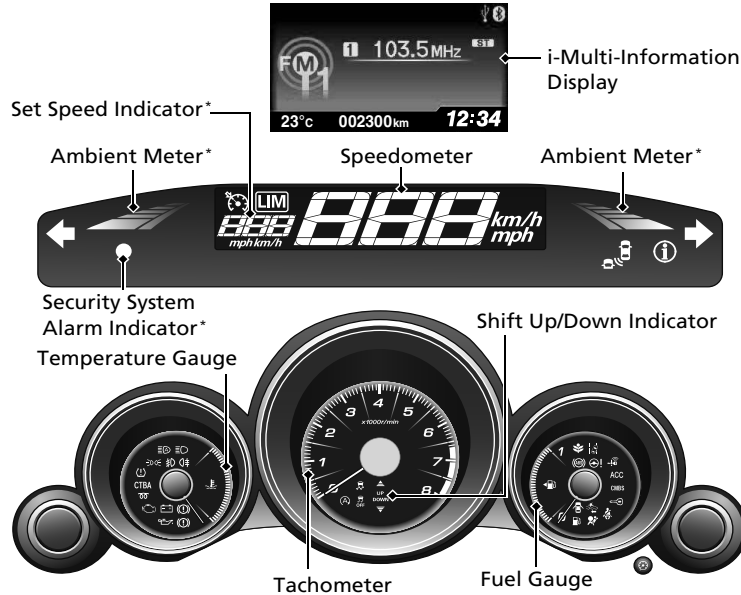

Except 2.0 L engine models

System Indicators





-  Malfunction Indicator Lamp
-  Low Oil Pressure Indicator
-  Charging System Indicator
-  Anti-lock Brake System (ABS) Indicator
-  Vehicle Stability Assist (VSA) System Indicator
-  VSA OFF Indicator
-  Door and Tailgate Open Indicator
-  ECON Mode Indicator
-  Immobilizer System Indicator
-  Parking Brake and Brake System Indicator (Red)
-  Brake System Indicator (Amber)
-  Keyless Access System Indicator*
-  Turn Signal and Hazard Warning Indicators
-  Blind Spot Information Indicator*















System Indicators

-  Low Tyre Pressure/Deflation Warning System Indicator
-  Electric Power Steering (EPS) System Indicator
-  Forward Collision Warning Indicator*
-  CTBA City-Brake Active System (CTBA) Indicator*















Lights Indicators

-  Lights On Indicator
-  High Beam Indicator
-  Front Fog Light Indicator*
-  Rear Fog Light Indicator

System Indicators



-  Lane Departure Warning Indicator*
-  Auto Idle Stop Indicator (Green)*
-  Auto Idle Stop System Indicator (Amber)*
-  Glow Plugs Indicator*
-  Low Fuel Indicator
-  Seat Belt Reminder Indicator
-  Supplemental Restraint System Indicator
-  High Beam Support System Indicator*
-  Cruise Main Indicator*
-  LIM Adjustable Speed Limiter Indicator*
-  System Message Indicator
-  P R N D S Shift Lever Position Indicator*
-  M (sequential shift mode) Indicator/Gear Position Indicator*/Shift Up/down Indicator

System Indicators

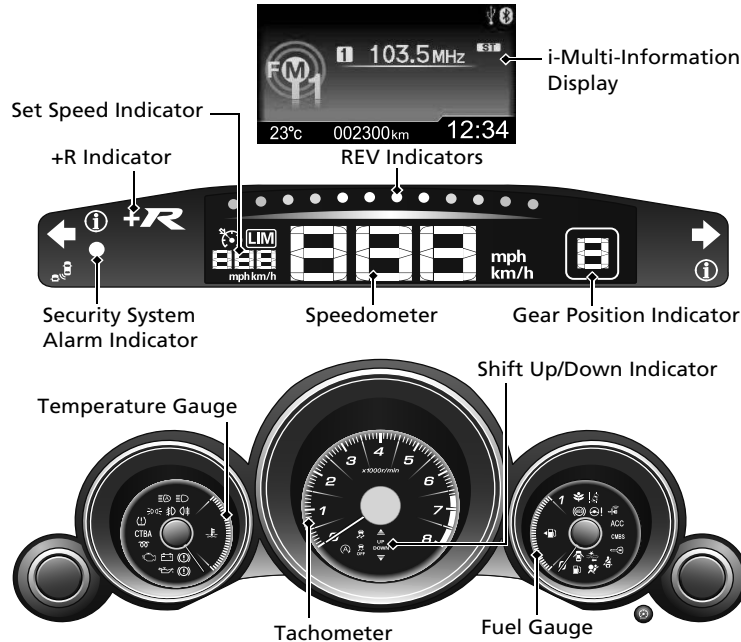
-  Malfunction Indicator Lamp
-  Low Oil Pressure Indicator
-  Charging System Indicator
-  Anti-lock Brake System (ABS) Indicator
-  Vehicle Stability Assist (VSA) System Indicator
-  VSA OFF Indicator
-  Door and Tailgate Open Indicator
-  Immobilizer System Indicator
-  Parking Brake and Brake System Indicator (Red)
-  Brake System Indicator (Amber)
-  Keyless Access System Indicator
-  Turn Signal and Hazard Warning Indicators
-  Blind Spot Information Indicator*
-  Lane Departure Warning Indicator*













System Indicators

-  Low Tyre Pressure Warning System Indicator
-  Electric Power Steering (EPS) System Indicator
-  Forward Collision Warning Indicator*
-  City-Brake Active System (CTBA) Indicator

Lights Indicators

-  Lights On Indicator
-  High Beam Indicator
-  Front Fog Light Indicator
-  Rear Fog Light Indicator

System Indicators

-  Auto Idle Stop Indicator (Green)
-  Auto Idle Stop System Indicator (Amber)
-  Low Fuel Indicator
-  Seat Belt Reminder Indicator
-  Supplemental Restraint System Indicator
-  High Beam Support System Indicator*
-  Cruise Main Indicator
-  Adjustable Speed Limiter Indicator
-  System Message Indicator
-  Shift Up/down Indicator











* Not available on all models

Controls P. 147

Clock P. 148

Models with one display



- 1 Press the **MENU** button.
- 2 Select **Adjust clock** with the  /  button, then press the **SOURCE** button.
- 3 Press the  /  button to change the setting between **12 h** and **24 h**.
- 4 Select hours or minutes with the  /  button.
- 5 Press the  /  button to adjust the numbers up or down.
- 6 Select  with the  /  button, then press the **SOURCE** button to enter your selection.



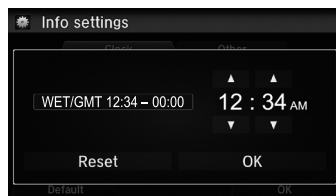

Models with navigation system

The navigation system receives signals from GPS satellites, updating the clock automatically.

Models with two displays



■ Using the Settings menu on the audio/information screen

- 1 Press the  button.
- 2 Select **Settings**.
- 3 Select **Info**.
- 4 Select the **Clock** tab.
- 5 Select **Clock Adjustment**.
- 6 Select  or  to change hour.
- 7 Select  or  to change minute, then select **OK**.

ENGINE START/STOP Button* P. 171

Press the button to change the vehicle's power mode.



Turn Signals P. 174

Turn Signal Control Lever

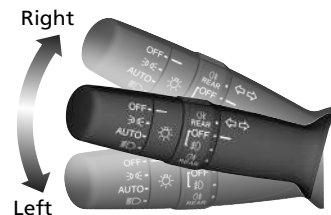

Lights P.174

Light Control Switches

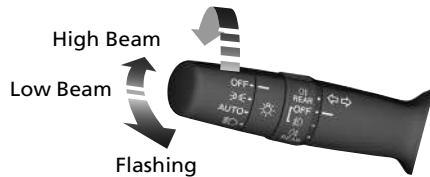

Wipers and Washers P.183

Wiper/Washer Control Lever

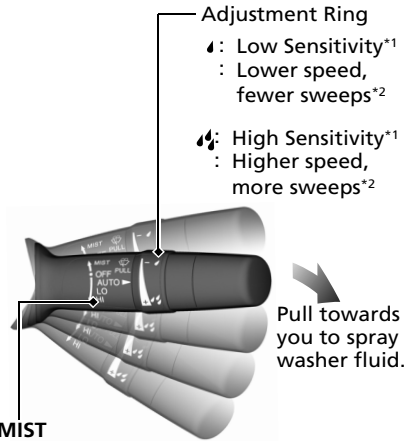

MIST
OFF

AUTO*1: Wiper speed varies automatically

INT*2: Low speed with intermittent

LO: Low speed wipe

HI: High speed wipe

*1: Vehicle with auto wiper

*2: Vehicle without auto wiper

Steering Wheel P.189

- To adjust, pull the adjustment lever towards you, adjust to the desired position, then lock the lever back in place.

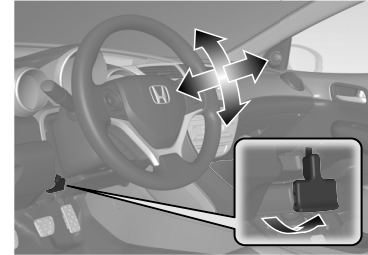

Unlocking the Front Doors from the Inside

 P.157

- Pull either front door inner handle to unlock and open it at the same time.

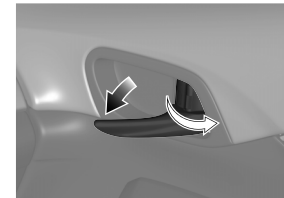

* Not available on all models

Tailgate P.159

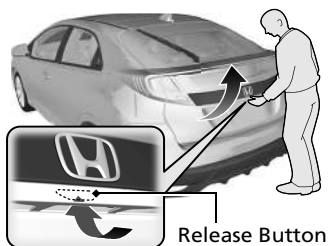

- Press the tailgate release button to unlock and open the tailgate.

Power Door Mirrors *

 P.191

- With the ignition switch in ON ^{*1}, move the selector switch to L or R.
- Push the appropriate edge of the adjustment switch to adjust the mirror.
- Press the folding button* to fold in and out the door mirrors.

Folding Button Selector Switch

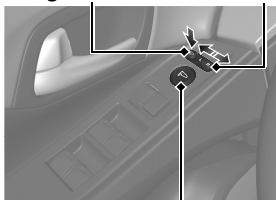

Adjustment Switch

Power Windows P.166

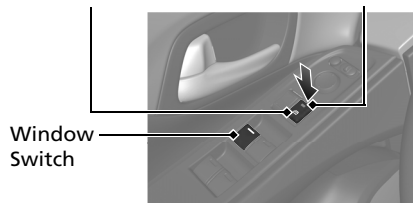

- With the ignition switch in ON ^{*1}, open and close the power windows.
- If the power window lock button is in the off position, each passenger's window can be opened and closed with its own switch.
- If the power window lock button is in the on position (indicator on), each passenger's window switch is disabled.

Power Window Lock Button Indicator







*1: Models with the keyless access system have an **ENGINE START/STOP** button instead of an ignition switch.

Climate Control System

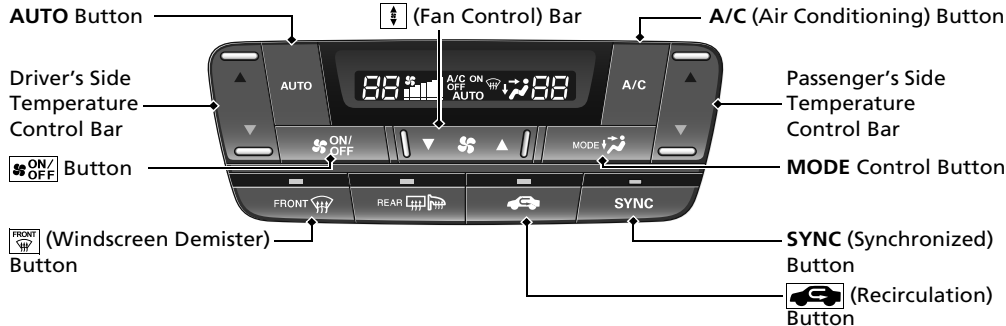
- Press the **AUTO** button to activate the climate control system.
- Press the  button to turn the system on or off.
- Press the  button to defrost the windscreen.

Models with synchronized mode



-  Air flows from dashboard vents.
-  Air flows from floor and dashboard vents.
-  Air flows from floor vents.
-  Air flows from floor and windscreen demister vents.

Models without synchronized mode

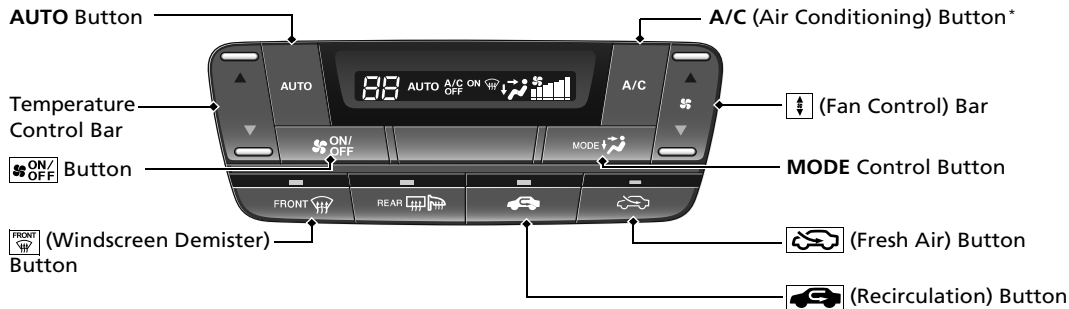

* Not available on all models

Features P. 221

Audio System* P. 222

For navigation system operation  See the Navigation System Manual

Models with one display

i-Multi-Information Display

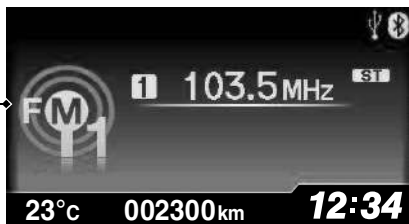

Models without DAB (Digital Audio Broadcasting)

Models with DAB (Digital Audio Broadcasting)

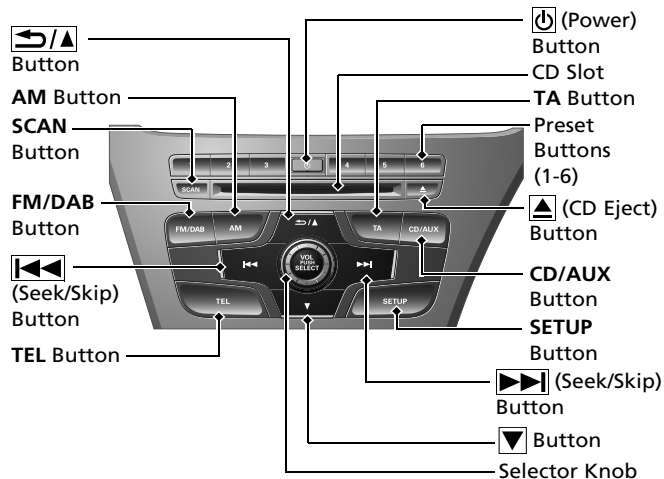
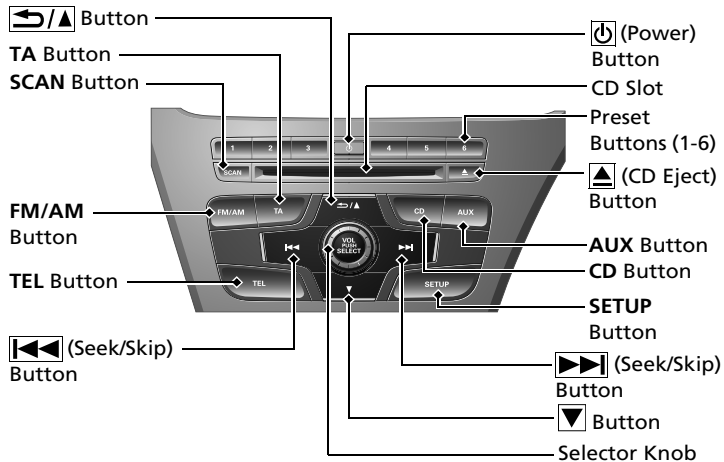

Models with two displays

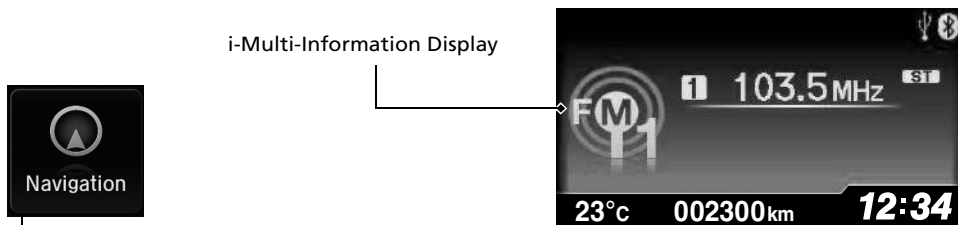

For navigation system operation See the Navigation System Manual

Models with navigation system



Audio/Information Screen

- Press the (Eject/Close) button to open the screen.

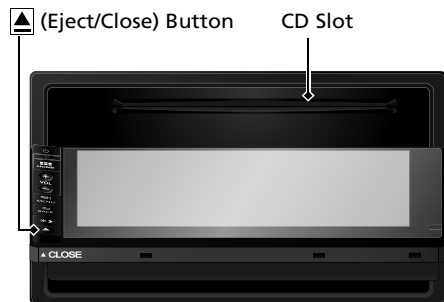



- Press the  (Eject/Close) button to return the screen to the upright position.

Audio Remote Controls

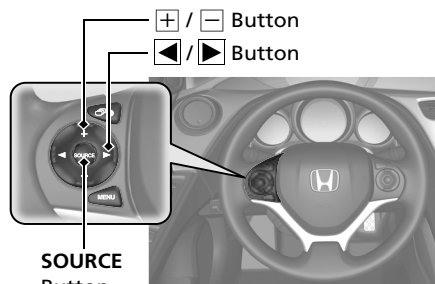
 P. 227





-  /  Button
Press to adjust the volume up/down.
- **SOURCE** Button

Models with one display

Press to change the audio mode: FM1/
FM2/DAB1*/DAB2*/LW/MW/CD/AUX

Models with two displays

Press to change the audio mode: FM/LW/
MW/DAB*/CD*/USB/iPod/Apps/Bluetooth®
Audio/AUX HDMI™

-  /  Button
Radio: Press to change the preset station.
Press and hold to select the next or previous strong station.

CD/USB device:

Press to skip to the beginning of the next song or return to the beginning of the current song.
Press and hold to change a folder.

Driving ➔ P. 371

Manual Transmission ➔ P. 395

Automatic Transmission ➔ P. 390

- Shift to **P** and depress the brake pedal when starting the engine.

Shifting

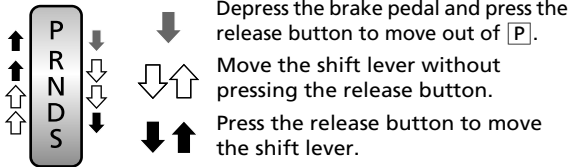

Depress the brake pedal and press the release button to move out of **P**.

Move the shift lever without pressing the release button.

Press the release button to move the shift lever.

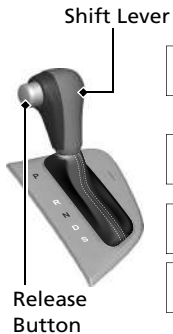

- P** **Park**
Turn off or start the engine. Transmission is locked.
- R** **Reverse**
Used when reversing.
- N** **Neutral**
Transmission is not locked.
- D** **Drive**
Normal driving. On models with paddle shifter, D-paddle shift mode can be used.
- S** **Drive (S)**
Sequential shift mode can be used.

Paddle Shifters ➔ P. 392,393

- Paddle shifters allow you to shift gears much like a manual transmission (1st through 5th). This is useful for engine braking.
- D-paddle shift mode: The transmission will shift back to automatic mode once the system detects that the vehicle is cruising.
- Sequential shift mode: Holds the selected gear, and the **M** indicator comes on.

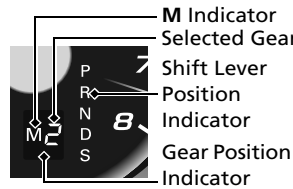

- The selected gear position is shown in the instrument panel.

Paddle Shifter (-) Paddle Shifter (+)

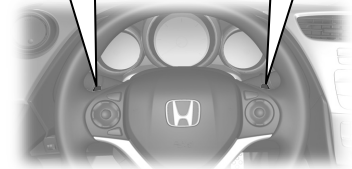
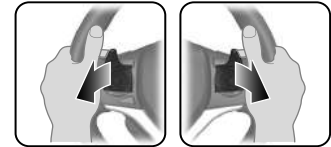

VSA OFF Button P. 423

- The vehicle stability assist (VSA) system helps to stabilise the vehicle during cornering, and helps to maintain traction while accelerating on loose or slippery road surfaces.
- VSA comes on automatically every time you start the engine.
- To turn VSA on or off, press and hold the button until you hear a beep.

Cruise Control* P. 404

- Cruise control allows you to maintain a set speed without keeping your foot on the accelerator pedal.
- To use cruise control, press the **MAIN** button. Select cruise control by pressing the **LIM** button, then press **-/SET** once you have achieved the desired speed (above 30 km/h or 19 mph).

Adjustable Speed

Limiter* P. 407

- This system enables you to set a maximum speed that cannot be exceeded even if you are depressing the accelerator pedal.
- To use the adjustable speed limiter, press the **MAIN** button. Select the adjustable speed limiter by pressing the **LIM** button, then press the **-/SET** when your vehicle reaches the desired speed.
- The vehicle speed limit can be set from 30 km/h (19 mph) to 250 km/h (155 mph).

Deflation Warning System (DWS) P. 428

The DWS detects a change in tyre revolutions as a decrease in tyre pressure.

Refueling P.452

Fuel recommendation: Premium unleaded petrol with a research octane number 95 or higher required

Fuel tank capacity: 50 L

- 1** Pull on the fuel fill door release handle under the driver's side lower outside corner of the dashboard.

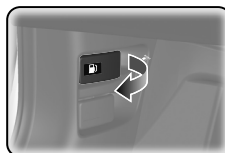

- 2** Turn the fuel fill cap slowly to remove the cap.

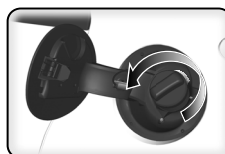

- 3** Place the cap in the holder on the fuel fill door.

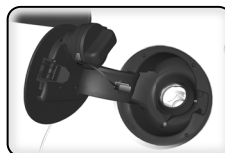

- 4** After refueling, screw the cap back on until it clicks at least once.

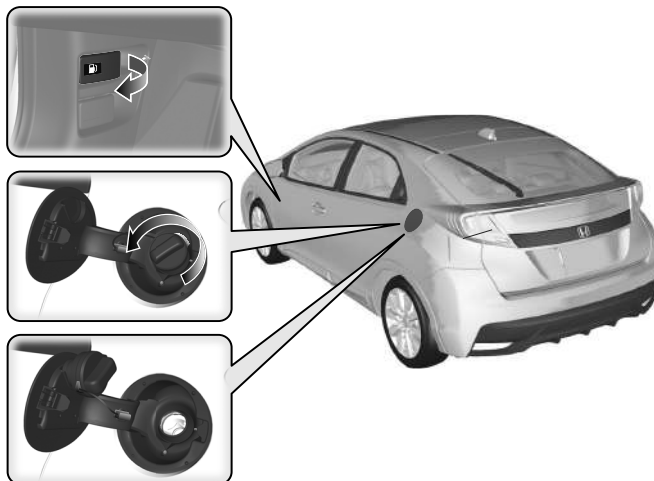

Diesel models

Refueling P. 453

Fuel recommendation: EN 590 standard diesel fuel

Fuel tank capacity: 50 L

- 1** Pull on the fuel fill door release handle under the driver's side lower outside corner of the dashboard.
- 2** After refueling, wait for about 10 seconds before removing the filler nozzle.

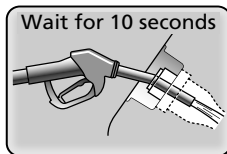
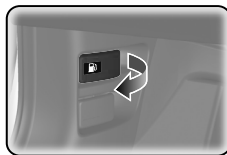

Maintenance [↔ P. 459](#)

Under the Bonnet [↔ P. 490](#)

- Check engine oil, engine coolant, and washer fluid. Add when necessary.
- Check brake fluid and clutch fluid*.
- Check the battery condition monthly.

- 1 Pull the bonnet release handle under the driver's side lower outside corner of the dashboard.

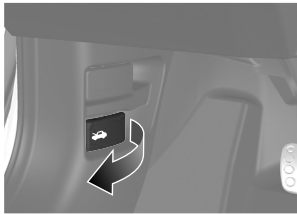

- 2 Locate the bonnet latch lever, pull the lever up, and lift up the bonnet.



- 3 When finished, close the bonnet and make sure it is firmly locked in place.

Wiper Blades [↔ P. 530](#)

- Replace blades if they leave streaks across the windscreen.

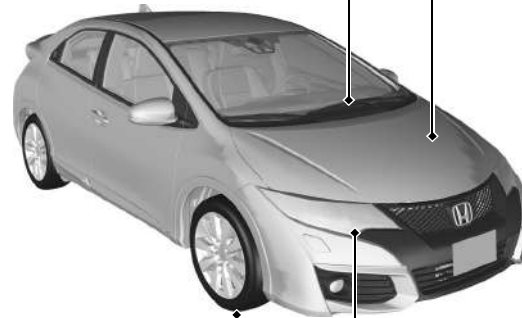

Tyres [↔ P. 534](#)

- Inspect tyres and wheels regularly.
- Check tyre pressures regularly.
- Install winter tyres for winter driving.

Lights [↔ P. 514](#)

- Inspect all lights regularly.

Handling the Unexpected ➔ P.555

Flat Tyre ➔ P.557

Models with a spare tyre

- Park in a safe location and replace the flat tyre with the compact spare tyre in the luggage area.

Models with tyre repair kit

- Park in a safe location and repair the flat tyre using the tyre repair kit.



Engine Won't Start ➔ P.574

- If the battery is dead, jump start using a booster battery.

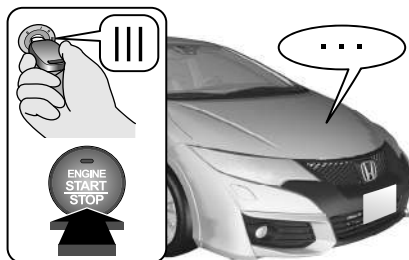

Overheating ➔ P.583

- Park in a safe location. If you do not see steam under the bonnet, open the bonnet, and let the engine cool down.



Indicators Come On ➔ P.587

- Identify the indicator and consult the owner's manual.

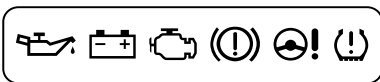

Blown Fuse ➔ P.592

- Check for a blown fuse if an electrical device does not operate.

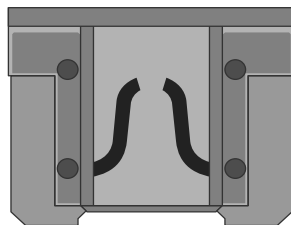

Emergency Towing ➔ P.599

- Call a professional towing service if you need to tow your vehicle.



What to Do If

Q The ignition switch does not turn from **0** to **I***1. Why?

- A**
- The steering wheel may be locked.
 - Try to turn the steering wheel left and right while turning the ignition key.
 - Move the steering wheel left and right after pressing the **ENGINE START/STOP** button.



Q The ignition switch does not turn from **I** to **0***1 and I cannot remove the key. Why?

- A** The shift lever should be moved to **P**.



Q Why does the brake pedal pulsate slightly when applying the brakes?

- A** This can occur when the ABS activates, and does not indicate a problem. Apply firm, steady pressure on the brake pedal. Never pump the brake pedal.

Q The rear door cannot be opened from inside the vehicle. Why?

- A** Check if the childproof lock is in the lock position. If so, open the rear door with the outside door handle. To cancel this function, push the lever to the unlock position.

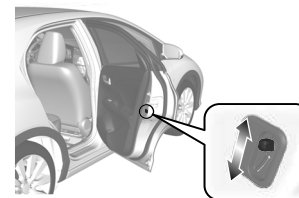

*1: Models with the keyless access system have an **ENGINE START/STOP** button instead of an ignition switch.

Q Why do the doors lock after I unlocked the doors using a remote transmitter?

A If you do not open a door within 30 seconds, the doors are relocked automatically for security.

Q Why does the beeper sound when I open the driver's door?

A The beeper sounds when:

- The exterior lights are left on.
- The power mode* is in ACCESSORY.
- Auto Idle Stop* is in operation.

Q Why does the beeper sound when I start driving?

A The beeper sounds when:

- Driver and/or front passenger are not wearing their seat belts.
- The parking brake lever is not fully released.

Q Why do I hear a screeching sound when I apply the brake pedal?

A The brake pads may need to be replaced. Have your vehicle inspected by a dealer.

Q **Petrol models**
Is it possible to use unleaded petrol with a Research Octane Number (RON) of 91 or higher on this vehicle?

A Unleaded petrol with a research octane number of 95 or higher is recommended.
Your vehicle is designed to operate on premium unleaded petrol with a research octane of 95 or higher. If this octane grade is unavailable, regular unleaded petrol with a research octane of 91 or higher may be used temporarily.
The use of regular unleaded petrol can cause metallic knocking noises in the engine and will result in decreased engine performance. The long-term use of regular-grade petrol can lead to engine damage.

Event Data Recorders

Your vehicle is equipped with several devices commonly referred to as Event Data Recorders. They record various types of real time vehicle data such as SRS airbag deployment and SRS system components failure.

This data belongs to the vehicle owner and may not be accessed by anyone else except as legally required or with the permission of the vehicle owner.



However this data may be accessed by Honda, its authorised dealers and authorised repairers, employees, representatives and contractors only for the purpose of the technical diagnosis, research and development of the vehicle.

Service Diagnostic Recorders

Your vehicle is equipped with service-related devices that record information about powertrain performance and driving conditions. The data can be used to help technicians diagnose, repair and maintain the vehicle. This data may not be accessed by anyone else except as legally required or with the permission of the vehicle owner.

However this data may be accessed by Honda, its authorised dealers and authorised repairers, employees, representatives and contractors only for the purpose of the technical diagnosis, research and development of the vehicle.

As you read this manual, you will find Information that is preceded by a symbol  **NOTICE**. This information is intended to help you avoid damage to your vehicle, other property, or the environment.

Symbols   on labels attached to your vehicle are to remind you to read this owner's manual for proper and safe operation of your vehicle.

 is colour-coded to indicate "danger" (red), "warning" (orange), or "caution" (amber).

A Few Words About Safety

Your safety, and the safety of others, is very important. And operating this vehicle safely is an important responsibility.

To help you make informed decisions about safety, we have provided operating procedures and other information on labels and in this manual. This information alerts you to potential hazards that could hurt you or others.

Of course, it is not practical or possible to warn you about all the hazards associated with operating or maintaining your vehicle. You must use your own good judgement.

You will find this important safety information in a variety of forms, including:

- **Safety Labels** - on the vehicle.
- **Safety Messages** - preceded by a safety alert symbol  and one of three signal words: **DANGER**, **WARNING**, or **CAUTION**. These signal words mean:

 **DANGER**

You **WILL** be **KILLED** or **SERIOUSLY HURT** if you don't follow instructions.

 **WARNING**

You **CAN** be **KILLED** or **SERIOUSLY HURT** if you don't follow instructions.

 **CAUTION**

You **CAN** be **HURT** if you don't follow instructions.

- **Safety Headings** - such as Important Safety Precautions.
- **Safety Section** - such as Safe Driving.
- **Instructions** - how to use this vehicle correctly and safely.

This entire book is filled with important safety information - please read it carefully.

Safe Driving

You can find many safety recommendations throughout this chapter, and throughout this manual.

For Safe Driving

Important Safety Precautions	32
Your Vehicle's Safety Features.....	34

Seat Belts

About Your Seat Belts.....	36
Fastening a Seat Belt.....	42
Seat Belt Inspection.....	46

Airbags

Airbag System Components.....	48
Types of Airbags	50
Front Airbags (SRS)	50
Side Airbags.....	55

Side Curtain Airbags.....	57
Airbag System Indicators.....	58
Airbag Care	60

Child Safety

Protecting Child Passengers	61
Safety of Infants and Small Children ..	64
Safety of Larger Children	76

Exhaust Gas Hazard

Carbon Monoxide Gas.....	79
--------------------------	----

Safety Labels

Label Locations	80
-----------------------	----

The following pages explain your vehicle's safety features and how to use them properly. The safety precautions below are ones that we consider to be among the most important.

Important Safety Precautions

■ Always wear your seat belt

A seat belt is your best protection in all types of collisions. Airbags are designed to supplement seat belts, not replace them. So even though your vehicle is equipped with airbags, make sure you and your passengers always wear your seat belts, and wear them properly.

■ Restrain all children

Children aged 12 and under should ride properly restrained in a back seat, not the front seat. Infants and small children should be restrained in a child restraint system. Larger children should use a booster seat and a lap/shoulder seat belt until they can use the belt properly without a booster seat.

■ Be aware of airbag hazards

While airbags can save lives, they can cause serious or fatal injuries to occupants who sit too close to them, or are not properly restrained. Infants, young children, and short adults are at the greatest risk. Be sure to follow all instructions and warnings in this manual.

■ Don't drink and drive

Alcohol and driving don't mix. Even one drink can reduce your ability to respond to changing conditions, and your reaction time gets worse with every additional drink. So don't drink and drive, and don't let your friends drink and drive, either.

ⓘ Important Safety Precautions

Some countries prohibit the use of mobile phones other than hands-free devices by the driver while driving.

■ **Pay appropriate attention to the task of driving safely**

Engaging in mobile phone conversation or other activities that keep you from paying close attention to the road, other vehicles, and pedestrians could lead to a crash. Remember, situations can change quickly, and only you can decide when it is safe to divert some attention away from driving.

■ **Control your speed**

Excessive speed is a major factor in crash injuries and deaths. Generally, the higher the speed, the greater the risk, but serious injuries can also occur at lower speeds. Never drive faster than is safe for current conditions, regardless of the maximum speed posted.

■ **Keep your vehicle in safe condition**

Having a tyre blowout or a mechanical failure can be extremely hazardous. To reduce the possibility of such problems, check your tyre pressures and condition frequently, and perform all regularly scheduled maintenance.

Your Vehicle's Safety Features

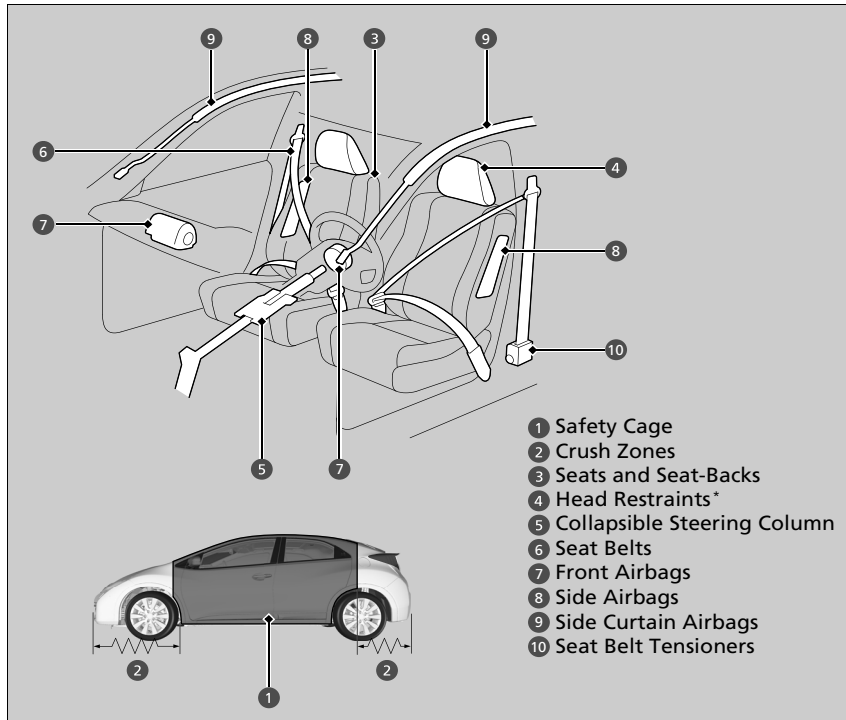

The following checklist will help you take an active role in protecting yourself and your passengers.

►► Your Vehicle's Safety Features

Your vehicle is equipped with many features that work together to help to protect you and your passengers during a crash.

Some features do not require any action on your part. These include a strong steel framework that forms a safety cage around the passenger compartment, front and rear crush zones, a collapsible steering column, and tensioners that tighten the front seat belts in a sufficient crash.

However, you and your passengers cannot take full advantage of these features unless you remain seated in the correct position and always wear your seat belts. In fact, some safety features can contribute to injuries if they are not used properly.

Safety Checklist

For the safety of you and your passengers, make a habit of checking these items each time before you drive.

- Adjust your seat to a position suitable for driving. Be sure the front seats are adjusted as far to the rear as possible while allowing the driver to control the vehicle. Sitting too close to a front airbag can result in serious or fatal injury in a crash.

➤ **Adjusting the Seats** P. 193

- Adjust head restraints to the proper position. Head restraints are most effective when the centre of the head restraint aligns with the centre of your head. Taller persons should adjust their head restraint to the highest position.

➤ **Adjusting the Head Restraints*** P. 196

- Always wear your seat belt, and make sure you wear it properly. Confirm that any passengers are properly belted as well.

➤ **Fastening a Seat Belt** P. 42

- Protect children by using seat belts or child restraint systems according to a child's age, height and weight.

➤ **Child Safety** P. 61

➤ Safety Checklist

If the door and tailgate open indicator is on, a door and/or the tailgate is not completely closed. Close all doors and the tailgate tightly until the indicator goes off.

➤ **Door and Tailgate Open Indicator** P. 89



* Not available on all models

About Your Seat Belts

Seat belts are the single most effective safety device because they keep you connected to the vehicle so that you can take advantage of many built-in safety features. They also help to keep you from being thrown against the inside of the vehicle, against other passengers, or out of the vehicle. When worn properly, seat belts also keep your body properly positioned in a crash so that you can take full advantage of the additional protection provided by the airbags.

In addition, seat belts help to protect you in almost every type of crash, including:

- frontal impacts
- side impacts
- rear impacts
- rollovers

About Your Seat Belts

WARNING

Not wearing a seat belt properly increases the chance of serious injury or death in a crash, even though your vehicle has airbags.

Be sure you and your passengers always wear seat belts and wear them properly.

WARNING: Seat belts are designed to bear upon the bony structure of the body, and should be worn low across the front of the pelvis or the pelvis, chest and shoulders, as applicable; wearing the lap section of the belt across the abdominal area must be avoided.

WARNING: Seat belts should be adjusted as firmly as possible, consistent with comfort, to provide the protection for which they have been designed. A slack belt will greatly reduce the protection afforded to the wearer.

WARNING: Belts should not be worn with straps twisted.

WARNING: Each belt assembly must only be used by one occupant; it is dangerous to put a belt around a child being carried on the occupant's lap.

■ Lap/shoulder seat belts

All four or five seating positions are equipped with lap/shoulder seat belts with emergency locking retractors. In normal driving the retractor lets you move freely while keeping some tension on the belt. During a collision or sudden stop the retractor locks to restrain your body.

▣ About Your Seat Belts

Seat belts cannot completely protect you in every crash. But in most cases, seat belts can reduce your risk of serious injury.

Most countries require you to wear seat belts. Take time to familiarise with the legal requirements of the countries in which you will drive.

The emergency locking retractor may lock if you lean forward too quickly. Slower movements will allow the belt to extend fully without locking.

Continued

■ Proper use of seat belts

Follow these guidelines for proper use:

- All occupants should sit upright, well back in the seat, and remain in that position for the duration of the trip. Slouching and leaning reduce the effectiveness of the belt and can increase the chance of serious injury in a crash.
- Never place the shoulder part of a lap/shoulder seat belt under your arm or behind your back. This could cause very serious injuries in a crash.
- Two people should never use the same seat belt. If they do, they could be very seriously injured in a crash.
- Do not put any accessories on the seat belts. Devices intended to improve comfort or reposition the shoulder part of a seat belt can reduce the protective capability and increase the chance of serious injury in a crash.

Seat Belt Reminder



■ Front seats

Your vehicle monitors front seat belt use. If the ignition switch is turned to ON ^{*1} before the driver's seat belt is fastened, the indicator will blink. If the driver does not fasten the belt, the indicator will remain on.

The beeper will also periodically sound and the indicator will blink while driving until the driver's seat belt is fastened.

*1: Models with the keyless access system have an **ENGINE START/STOP** button instead of an ignition switch.

⊠ Seat Belt Reminder

The indicator will also come on if a front passenger does not fasten their seat belt within six seconds after the ignition switch is turned to ON ^{*1}.

When no one is sitting in the front passenger's seat, or a child or small adult is riding there, the indicator will not come on.

If the indicator comes on or the beeper sounds with no front passenger, or with a passenger wearing the seat belt, something may be interfering with the occupant detection sensor. Check if:

- Heavy items are on the seat.
- A cushion is placed on the seat.
- The front passenger is not sitting properly.

If none of these conditions exist, have your vehicle checked by a dealer as soon as possible.

Continued

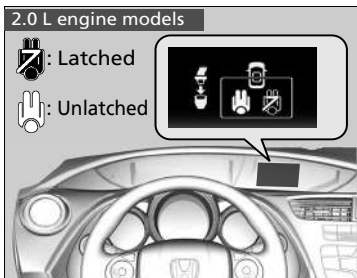
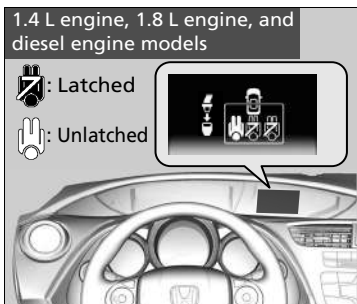

■ Rear seats

Your vehicle monitors rear seat belt use. An i-multi-information display notifies you if any of the rear seat belts are used.

To see the display:

1. Press the **MENU** button.
2. Select **Vehicle information** with the $\boxed{+}$ / $\boxed{-}$ button, then press the **SOURCE** button.
3. Select **Rear seatbelt information** with the $\boxed{+}$ / $\boxed{-}$ button, then press the **SOURCE** button.

Automatic Seat Belt Tensioners

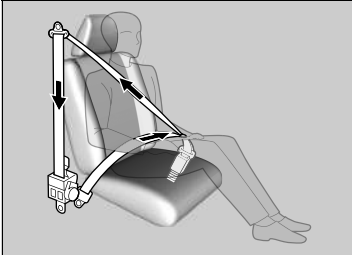

The front seats are equipped with automatic seat belt tensioners to enhance safety.

The tensioners automatically tighten the front seat belts during a moderate-to-severe frontal collision, sometimes even if the collision is not severe enough to inflate the front airbags.

Automatic Seat Belt Tensioners

The seat belt tensioners can only operate once. If a tensioner is activated, the SRS indicator will come on. Have a dealer replace the tensioner and thoroughly inspect the seat belt system as it may not offer protection in a subsequent crash.

During a moderate-to-severe side impact, the tensioner on that side of the vehicle also activates.

Fastening a Seat Belt

After adjusting a front seat to the proper position, and while sitting upright and well back in the seat:

► Adjusting the Seats P. 193

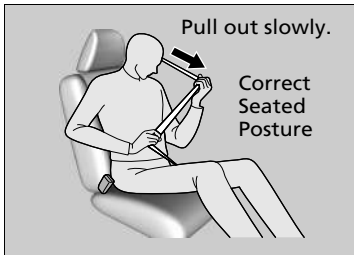

1. Pull the seat belt out slowly.

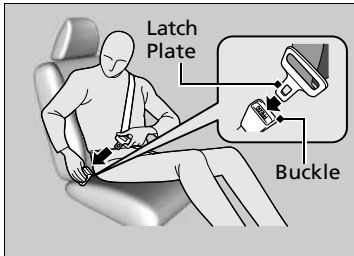

2. Insert the latch plate into the buckle, then tug on the belt to make sure the buckle is secure.
 - Make sure that the belt is not twisted or caught on anything.

► Fastening a Seat Belt

No one should sit in a seat with an inoperative seat belt or one that does not appear to be working correctly. Using a seat belt that is not working properly may not protect the occupant in a crash. Have a dealer check the belt as soon as possible.

Never insert any foreign objects into the buckle or retractor mechanism.



3. Position the lap part of the belt as low as possible across your hips, then pull up on the shoulder part of the belt so the lap part fits snugly. This lets your strong pelvic bones take the force of a crash and reduces the chance of internal injuries.
4. If necessary, pull up on the belt again to remove any slack, then check that the belt rests across the centre of your chest and over your shoulder. This spreads the forces of a crash over the strongest bones in your upper body.

Fastening a Seat Belt

⚠ WARNING

Improperly positioning the seat belts can cause serious injury or death in a crash.

Make sure all seat belts are properly positioned before driving.

To release the belt, push the red **PRESS** button then guide the belt by hand until it has retracted completely.

When exiting the vehicle, be sure the belt is out of the way and will not get caught by closing the door.

Never insert any foreign objects into the buckle or retractor mechanism.

Continued

■ Adjusting the Shoulder Anchor

The front seats have adjustable shoulder anchors to accommodate taller and shorter occupants.

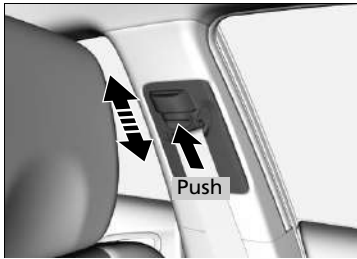

1. Move the anchor up and down while holding the release button.
2. Position the anchor so that the belt rests across the centre of your chest and over your shoulder.

▣ Adjusting the Shoulder Anchor

The shoulder anchor height can be adjusted to four levels. If the belt contacts your neck, lower the height one level at a time.

After an adjustment, make sure that the shoulder anchor position is secure.

■ Advice for Pregnant Women

If you are pregnant, the best way to protect yourself and your unborn child when driving or riding in a vehicle is to always wear a seat belt and keep the lap part of the belt as low as possible across the hips.

Wear the shoulder belt across the chest avoiding the abdomen.



Wear the lap part of the belt as low as possible across the hips.

▣ Advice for Pregnant Women

Each time you have a checkup, ask your doctor if it is okay for you to drive.

To reduce the risk of injuries to both you and your unborn child that can be caused by an inflating front airbag:

- When driving, sit upright and adjust the seat as far back as possible while allowing full control of the vehicle.
- When sitting in the front passenger's seat, adjust the seat as far back as possible.

Seat Belt Inspection

Regularly check the condition of your seat belts as follows:

- Pull each belt out fully, and look for frays, cuts, burns, and wear.
- Check that the latches work smoothly and the belts retract easily.
 - ▶ If a belt does not retract easily, cleaning the belt may correct the problem. Only use a mild soap and warm water. Do not use bleach or cleaning solvents. Make sure the belt is completely dry before allowing it to retract.

Any belt that is not in good condition or working properly will not provide proper protection and should be replaced as soon as possible.

A belt that has been worn during a crash may not provide the same level of protection in a subsequent crash. Have your seat belts inspected by a dealer after any collision.

Seat Belt Inspection

WARNING

Not checking or maintaining seat belts can result in serious injury or death if the seat belts do not work properly when needed.

Check your seat belts regularly and have any problem corrected as soon as possible.

WARNING: No modifications or additions should be made by the user which will either prevent the seat belt adjusting devices from operating to remove slack, or prevent the seat belt assembly from being adjusted to remove slack.

WARNING: It is essential to replace the entire assembly after it has been worn in a severe impact even if damage to the assembly is not obvious.

WARNING: Care should be taken to avoid contamination of the webbing with polishes, oils and chemicals, and particularly battery acid. Cleaning may safely be carried out using mild soap and water. The belt should be replaced if webbing becomes frayed, contaminated or damaged.

■ Anchorage points

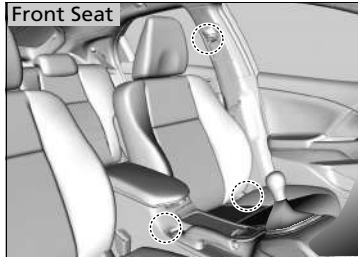

When replacing the seat belts, use the anchorage points shown in the images. The front seat has a lap/shoulder belt.

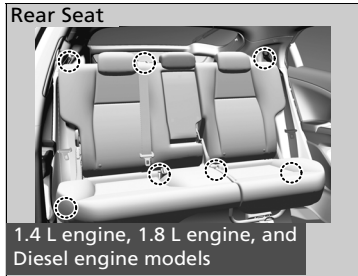

1.4 L engine, 1.8 L engine, and diesel engine models

The rear seat has three lap/shoulder belts.

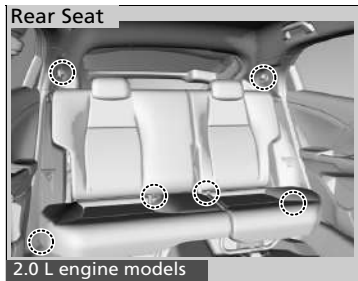

2.0 L engine models

The rear seat has two lap/shoulder belts.

Airbag System Components

The front, front side, and side curtain airbags are deployed according to the direction and severity of impact. The airbag system includes:

- Two SRS (Supplemental Restraint System) front airbags. The driver's airbag is stored in the centre of the steering wheel; the front passenger's airbag is stored in the dashboard. Both are marked **SRS AIRBAG**.
- Two side airbags, one for the driver and one for a front passenger. The airbags are stored in the outer edges of the seat-backs. Both are marked **SIDE AIRBAG**.
- Two side curtain airbags, one for each side of the vehicle. The airbags are stored in the ceiling, above the side windows. The front and rear pillars are marked **SIDE CURTAIN AIRBAG**.
- An electronic control unit that continually monitors and records information about the sensors, the airbag activators, the seat belt tensioners, and driver and front passenger seat belt use when the ignition switch is in ON ^{*1}.
- Automatic front seat belt tensioners.
- Impact sensors that can detect a moderate-to-severe front or side impact.
- An indicator on the instrument panel that alerts you to a possible problem with your airbag system or seat belt tensioners.
- An indicator on the dashboard that alerts you that the passenger's front airbag has been turned off.

*1: Models with the keyless access system have an **ENGINE START/STOP** button instead of an ignition switch.

■ Important Facts About Your Airbags

Airbags can pose serious hazards. To do their job, airbags must inflate with tremendous force. So, while airbags help to save lives, they can cause burns, bruises, and other minor injuries, sometimes even fatal ones if occupants are not wearing their seat belts properly and sitting correctly.

What you should do: Always wear your seat belt properly, and sit upright and as far back from the steering wheel as possible while allowing full control of the vehicle. A front passenger should move their seat as far back from the dashboard as possible.

Remember, however, that no safety system can prevent all injuries or deaths that can occur in a severe crash, even when seat belts are properly worn and the airbags deploy.

Do not place hard or sharp objects between yourself and a front airbag.

Carrying hard or sharp objects on your lap, or driving with a pipe or other sharp object in your mouth, can result in injuries if your front airbag inflates.

Do not attach or place objects on the front airbag covers. Objects on the covers marked **SRS AIRBAG** could interfere with the proper operation of the airbags or be propelled inside the vehicle and hurt someone if the airbags inflate.

▣ Important Facts About Your Airbags

Do not attempt to deactivate your airbags. Together, airbags and seat belts provide the best protection.

When driving, keep hands and arms out of the deployment path of the front airbag by holding each side of the steering wheel. Do not cross an arm over the airbag cover.

Types of Airbags

Your vehicle is equipped with three types of airbags:

- **Front airbags:** Airbags in front of the driver's and front passenger's seats.
- **Side airbags:** Airbags in the driver's and front passenger's seat-backs.
- **Side curtain airbags:** Airbags above the side windows.

Each is discussed in the following pages.

Front Airbags (SRS)

The front SRS airbags inflate in a moderate-to-severe frontal collision to help to protect the head and chest of the driver and/or front passenger.

SRS (Supplemental Restraint System) indicates that the airbags are designed to supplement seat belts, not replace them. Seat belts are the occupant's primary restraint system.

Housing Locations

The front airbags are housed in the centre of the steering wheel for the driver, and in the dashboard for the front passenger. Both airbags are marked **SRS AIRBAG**.

Types of Airbags

The airbags can inflate whenever the ignition switch is in ON ^{*1}.

After an airbag inflates in a crash, you may see a small amount of smoke. This is from the combustion process of the inflator material and is not harmful. People with respiratory problems may experience some temporary discomfort. If this occurs, get out of the vehicle as soon as it is safe to do so.

*1: Models with the keyless access system have an **ENGINE START/STOP** button instead of an ignition switch.

Front Airbags (SRS)

During a frontal crash severe enough to cause one or both front airbags to deploy, the airbags can inflate at different rates, depending on the severity of the crash, whether or not the seat belts are latched, and/or other factors. Frontal airbags are designed to supplement the seat belts to help to reduce the likelihood of head and chest injuries in frontal crashes.

■ Operation

Front airbags are designed to inflate during moderate-to-severe frontal collisions. When the vehicle decelerates suddenly, the sensors send information to the control unit which signals one or both front airbags to inflate.

A frontal collision can be either head-on or angled between two vehicles, or when a vehicle crashes into a stationary object, such as a concrete wall.

■ How the Front Airbags Work

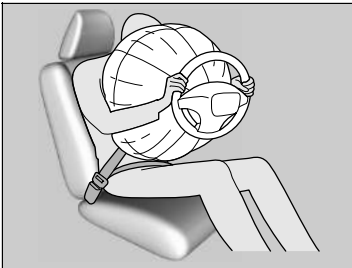

While your seat belt restrains your torso, the front airbag provides supplemental protection for your head and chest.

The front airbags deflate immediately so that they won't interfere with the driver's visibility or the ability to steer or operate other controls.

The total time for inflation and deflation is so fast that most occupants are not aware that the airbags deployed until they see them lying in front of them.

▣ How the Front Airbags Work

Although the driver's and front passenger's airbags normally inflate within a split second of each other, it is possible for only one airbag to deploy. This can happen if the severity of a collision is at the margin, or threshold that determines whether or not the airbags will deploy. In such cases, the seat belt will provide sufficient protection, and the supplemental protection offered by the airbag would be minimal.

Continued

■ When front airbags should not deploy

Minor frontal crashes: Front airbags were designed to supplement seat belts and help to save lives, not to prevent minor scrapes, or even broken bones that might occur during a less than moderate-to-severe frontal crash.

Side impacts: Front airbags can provide protection when a sudden deceleration causes a driver or front passenger to move towards the front of the vehicle. Side airbags and side curtain airbags have been specifically designed to help to reduce the severity of injuries that can occur during a moderate-to-severe side impact which can cause the driver or passenger to move towards the side of the vehicle.

Rear impacts: Head restraints and seat belts are your best protection during a rear impact. Front airbags cannot provide any significant protection and are not designed to deploy in such collisions.

Rollovers: Seat belts, side airbags and side curtain airbags offer the best protection in a rollover. Because front airbags could provide little if any protection, they are not designed to deploy during a rollover.

■ When front airbags deploy with little or no visible damage

Because the airbag system senses sudden deceleration, a strong impact to the vehicle framework or suspension might cause one or more of the airbags to deploy. Examples include running into a curb, the edge of a hole, or other low fixed object that causes a sudden deceleration in the vehicle chassis. Since the impact is underneath the vehicle, damage may not be readily apparent.

■ When front airbags may not deploy, even though exterior damage appears severe

Since crushable body parts absorb crash energy during an impact, the amount of visible damage does not always indicate proper airbag operation. In fact, some collisions can result in severe damage but no airbag deployment because the airbags would not have been needed or would not have provided protection even if they had deployed.

Passenger Front Airbag Off System

If it is unavoidable to install a rear-facing child restraint system in the front passenger seat, you must manually deactivate the passenger front airbag system, using the ignition key.

Passenger front airbag ON/OFF switch

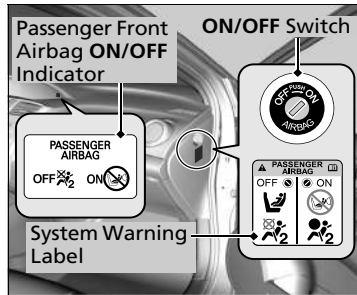

When the passenger front airbag **ON/OFF** switch is in:

OFF: The passenger front airbag is deactivated. The passenger front airbag does not inflate during a severe frontal crash that inflates driver front airbag.

The passenger front airbag off indicator stays on as a reminder.

ON: The passenger front airbag is activated. The passenger front airbag on indicator is comes on and remain on for about 60 seconds.

To deactivate the passenger front airbag system

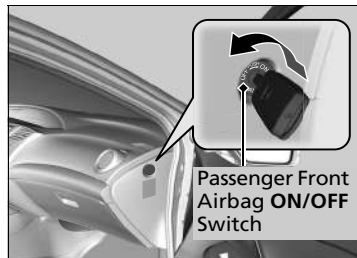

1. Set the parking brake, and turn the ignition switch to LOCK [0]*1. Remove the key.

2. Open the front passenger's door.

3. Insert the ignition key to the passenger front airbag **ON/OFF** switch.

▶ The switch is located at the side panel of the front passenger side instrument panel.

4. Turn the key to **OFF**, and remove it from the switch.

*1: Models with the keyless access system have an **ENGINE START/STOP** button instead of an ignition switch.

Passenger Front Airbag Off System

⚠ WARNING

The passenger front airbag system must be turned off, if it is not avoidable to put a rear-facing child restraint system in the front passenger seat.

If the front passenger airbag inflates, it can hit the rear-facing child restraint system with enough force to kill or cause a very serious injury to the infant.

⚠ WARNING

Make sure to turn on the passenger front airbag system when a rear-facing child restraint system is not used on the front passenger seat.

Leaving the passenger front airbag system deactivated can result in serious injury or death in a crash.

Continued

■ Passenger front airbag off indicator

When the passenger front airbag system is activated, the indicator goes off after a few seconds when you turn the ignition switch to ON *1.

When the passenger front airbag system is deactivated, the indicator stays on, or goes off momentarily and comes back on.

■ Passenger front airbag off system label

The label is located at the side panel of the front passenger side instrument panel.

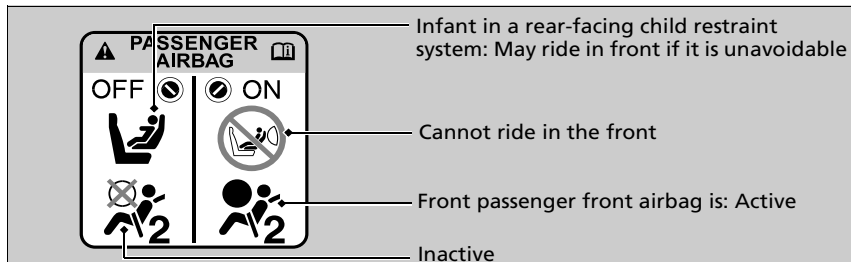

▶▶ Passenger Front Airbag Off System

NOTICE

- Use your vehicle's ignition key to turn the passenger front airbag **ON/OFF** switch. If you use a different key, the switch can be damaged, or the passenger front airbag system may not work properly.
- Do not close the door or apply excessive load on the ignition key while the key is in the passenger front airbag **ON/OFF** switch. The switch or the key can be damaged.

We strongly recommend that you must not install a rear-facing child restraint system in the front passenger seat.

Protecting Infants P. 64

It is your responsibility to change the setting of the passenger front airbag system to **OFF** when you put a rear-facing child restraint system on the front passenger seat.

When a rear-facing child restraint system is not in use in the front passenger seat, turn the system back on.

*1: Models with the keyless access system have an **ENGINE START/STOP** button instead of an ignition switch.

Side Airbags

The side airbags help to protect the upper torso of the driver or a front passenger during a moderate-to-severe side impact.

Your vehicle has the safety label on the front doorjamb to remind you of the side airbag hazards.

The side airbags are especially hazardous if a child is sitting in the front seat.

Housing Locations

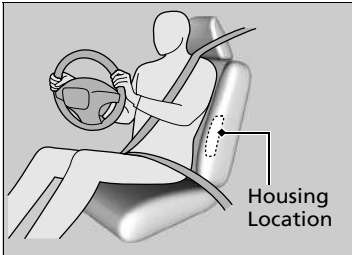

The side airbags are housed in the outside edge of the driver's and passenger's seat-backs.

Both are marked **SIDE AIRBAG**.

Side Airbags

⚠ WARNING



Leaning over the front door can result in serious injury or death if the side airbag inflates.

Always sit upright with their back against the seat-back.

Do not attach accessories on or near the side airbags. They can interfere with the proper operation of the airbags, or hurt someone if an airbag inflates.

If the impact is on the passenger side, the airbag deploys even if there is no passenger in the passenger's seat.

■ Operation

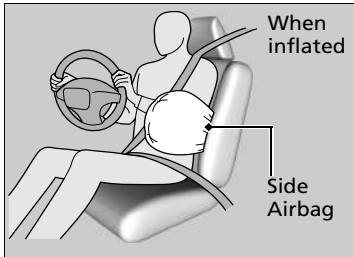

When the sensors detect a moderate-to-severe side impact, the control unit signals the side airbag on the impact side to immediately inflate.

■ When a side airbag deploys with little or no visible damage

Because the airbag system senses sudden acceleration, a strong impact to the side of the vehicle's framework can cause a side airbag to deploy. In such cases, there may be little or no damage, but the side impact sensors detected a severe enough impact to deploy the airbag.

■ When a side airbag may not deploy, even though visible damage appears severe

It is possible for a side airbag to not deploy during an impact that results in apparently severe damage. This can occur when the point of impact was towards the far front or rear of the vehicle, or when the vehicle's crushable body parts absorbed most of the crash energy. In either case, the side airbag would not have been needed nor provided protection even if it had deployed.

⌘ Side Airbags

Do not cover or replace the front seat-back covers without consulting a dealer. Improperly replacing or covering front seat-back covers can prevent your side airbags from properly deploying during a side impact.

Do not let the front passenger lean sideways with their head in the deployment path of the side airbag. An inflating side airbag can strike with strong force and seriously injure the passenger.

Side Curtain Airbags

The side curtain airbags help to protect the heads of the driver and passengers in outer seating positions during a moderate-to-severe side impact.

Housing Locations



The side curtain airbags are located in the ceiling above the side windows on both sides of the vehicle.

Operation

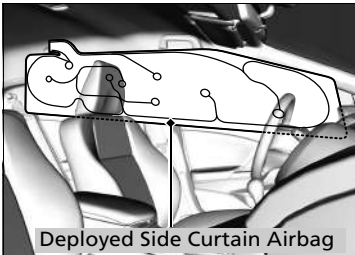

The side curtain airbag is designed to deploy in a moderate-to-severe side impact.

■ When side curtain airbags deploy in a frontal collision

One or both side curtain airbags may inflate in a moderate-to-severe angled frontal collision.

In this case, the side curtain airbags will deploy slightly after the front airbags.

Side Curtain Airbags

The side curtain airbags are most effective when an occupant is wearing their seat belt properly and sitting upright, well back in their seat.

Do not attach any objects to the side windows or roof pillars as they can interfere with the proper operation of the side curtain airbags.

Do not put a coat hanger or hard objects on a coat hook. This could result in injuries if your side curtain airbag inflates.

Airbag System Indicators

If a problem occurs in the airbag system, the SRS indicator comes on and a message appears on the i-multi-information display.

■ SRS (Supplemental Restraint System) Indicator

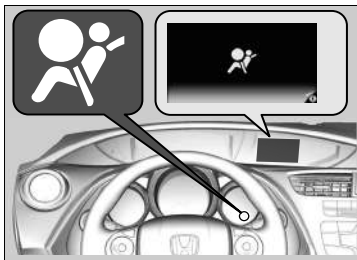

■ When the ignition switch is turned to ON *1

The indicator comes on for a few seconds, then goes off. This tells you the system is working properly.

If the indicator comes on at any other time, or does not come on at all, have the system checked by a dealer as soon as possible. If you don't, your airbags and seat belt tensioners may not work properly when they are needed.

*1: Models with the keyless access system have an **ENGINE START/STOP** button instead of an ignition switch.

⚠ SRS (Supplemental Restraint System) Indicator

⚠ WARNING

Ignoring the SRS indicator can result in serious injury or death if the airbag systems or tensioners do not work properly.

Have your vehicle checked by a dealer as soon as possible if the SRS indicator alerts you to a possible problem.

⚠ WARNING

Remove the rear-facing child restraint system immediately from the front passenger seat if the SRS indicator comes on. Even if the passenger front airbag has been deactivated, do not ignore the SRS indicator.

The SRS system may have a fault which could cause the passenger front airbag to be activated, causing serious injury or death.

Passenger Front Airbag Off Indicator

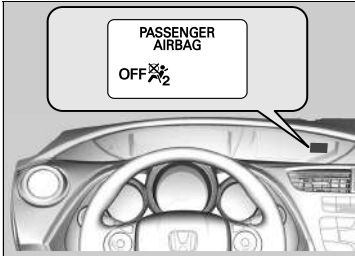

■ When the passenger airbag off indicator comes on

The indicator stays on while the passenger's front airbag system is deactivated.

When a rear-facing child restraint system is not in use in the front passenger seat, manually turn the system back on. The indicator should go off.

Airbag Care

You do not need to, and should not, perform any maintenance on or replace any airbag system components yourself. However, you should have your vehicle inspected by a dealer in the following situations:

■ When the airbags have deployed

If an airbag has inflated, the control unit and other related parts must be replaced. Similarly, once an automatic seat belt tensioner has been activated, it must be replaced.

■ When the vehicle has been in a moderate-to-severe collision

Even if the airbags did not inflate, have your dealer inspect the following: front seat belt tensioners, and each seat belt that was worn during the crash.

✘ Airbag Care

The removal of airbag components from the vehicle is prohibited.

In case of malfunction, or shutdown, or after the airbag inflation/seat belt tensioner operation, ask a qualified personnel for handling.

We recommend against the use of salvaged airbag system components, including the airbag, tensioners, sensors, and control unit.

Protecting Child Passengers

Each year, many children are injured or killed in vehicle crashes because they are either unrestrained or not properly restrained. In fact, vehicle accidents are the number one cause of death of children aged 12 and under.

To reduce the number of child deaths and injuries, infants and children should be properly restrained when they ride in a vehicle.

Protecting Child Passengers

⚠ WARNING

Children who are unrestrained or improperly restrained can be seriously injured or killed in a crash.

Any child too small for a seat belt should be properly restrained in an approved child restraint system. A larger child should be properly restrained with a seat belt, using a booster seat if necessary.

In many countries, the law requires all children aged 12 and under, and whose height are shorter than 150 cm (60 inches) be properly restrained in a rear seat.

In many countries, it is required to use an officially approved and suitable child restraint system for transporting a child on any passenger seat. Check your local legal requirement.

European models

Child restraint systems must meet the UN-ECE R44 or the regulations of the subject countries.

➔ **Selecting a Child Restraint System** P. 67

Except European models

We recommend that child restraint systems meet the UN-ECE R44 or the regulations of the subject countries.

Children should sit properly restrained in a rear seat. This is because:

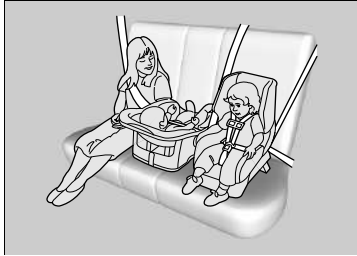

- An inflating front or side airbag can injure or kill a child sitting in the front seat.
- A child in the front seat is more likely to interfere with the driver's ability to safely control the vehicle.
- Statistics show that children of all sizes and ages are safer when they are properly restrained in a rear seat.

- Any child who is too small to wear a seat belt must be properly restrained in an approved child restraint system that is properly secured to the vehicle using the lap belt portion of the lap/shoulder belt.
- Never hold a child on your lap because it is impossible to protect them in the event of a collision.
- Never put a seat belt over yourself and a child. During a crash, the belt would likely press deep into the child and cause serious or fatal injuries.
- Never let two children use the same seat belt. Both children could be very seriously injured in a crash.
- Do not allow children to operate the doors, windows or seat adjustments.
- Do not leave children in the vehicle unattended, especially in hot weather when the inside of the vehicle can get hot enough to kill them. They could also activate vehicle controls causing it to move unexpectedly.

► Protecting Child Passengers

Front Passenger's Sun Visor

⚠ WARNING



NEVER use a rearward facing child restraint on a seat protected by an ACTIVE AIRBAG in front of it, DEATH or SERIOUS INJURY to the CHILD can occur.

WARNING: Use the power window lock button to prevent children from opening the windows. Using this feature will prevent children from playing with the windows, which could expose them to hazards or distract the driver.

► **Opening/Closing the Power Windows** P. 166

WARNING: Always take the ignition key with you whenever you leave the vehicle alone (with other occupants).

Safety of Infants and Small Children

Protecting Infants

An infant must be properly restrained in a rear-facing, reclining child restraint system until the infant reaches the seat maker's weight or height limit for the seat, and the infant is at least one year old.

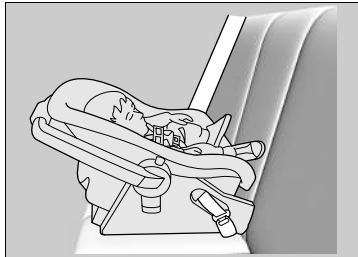

Positioning a rear-facing child restraint system

Child restraint system must be placed and secured in a rear seating position.

Protecting Infants

⚠ WARNING

Placing a rear-facing child restraint system in the front seat can result in serious injury or death if the passenger's front airbag inflates.

Always place a rear-facing child restraint system in the back seat, not the front.

As required by UN-ECE R94 Regulation:

⚠ WARNING



NEVER use a rearward facing child restraint on a seat protected by an ACTIVE AIRBAG in front of it, DEATH or SERIOUS INJURY to the CHILD can occur.

When properly installed, a rear-facing child restraint system may prevent the driver or a front passenger from moving their seat all the way back, or from locking their seat-back in the desired position.

✘ Protecting Infants

If the passenger's front airbag inflates, it can hit the rear-facing child restraint system with great force, which can dislodge or strike the system, and seriously injure the child.

Rear-facing child restraint systems should never be installed in a front facing position.

Always refer to the child restraint system manufacturer's instructions before installation.

If it is absolutely unavoidable to install a rear-facing child restraint system in the front passenger seat, manually turn off the passenger front airbag system.

✘ **Passenger Front Airbag Off System** P. 53

Continued

Protecting Smaller Children

If a child is at least one year old and within the weight range indicated by the child restraint system manufacturer, the child should be properly restrained in a firmly secured front facing child restraint system.

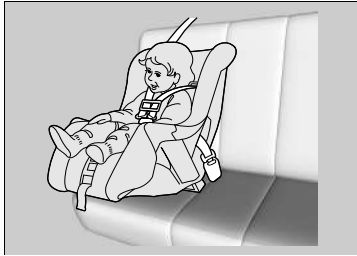

■ Front facing child restraint system placement

We strongly recommend placing a front facing child restraint system in a rear seating position.

Placing a front facing child restraint system in the front seat can be hazardous. A rear seat is the safest place for a child.

Protecting Smaller Children

⚠ WARNING

Placing a front facing child restraint system in the front seat can result in serious injury or death if the front airbag inflates.

If you must place a front facing child restraint system in front, move the vehicle seat as far back as possible, and properly restrain the child.

Educate yourself about the laws and regulations regarding child restraint system use where you are driving, and follow the child restraint system manufacturer's instructions.

Many experts recommend use of a rear-facing child restraint system for a child up to two years old, if the child's height and weight are appropriate for a rear-facing child restraint system.

■ Selecting a Child Restraint System

Some child restraint systems are lower anchorage compatible. Some have a rigid-type connector while others have a flexible-type connector. Both are equally easy to use. Some existing and previously owned child restraint systems can only be installed using the seat belt. Whichever type you choose, follow the child restraint system manufacturer's use and care instructions as well as the instructions in this manual. Proper installation is key to maximizing your child's safety.

The flexible type may not be available in your country.

In seating positions not equipped with lower anchorages, install a child restraint system using the seat belt and a top tether for added security. This is because all child restraint systems must be secured with a lap belt or the lap part of a lap/shoulder belt when not using the lower anchorage system. In addition, the child restraint system manufacturer may advise that a seat belt be used to attach an ISO FIX restraint system once a child reaches a specified weight. Please read the child restraint system owner's manual for proper installation instructions.

■ Important consideration when selecting a child restraint system

Make sure the child restraint system meets the following three requirements:

- The child restraint system is the correct type and size for the child.
- The child restraint system is the correct type for the seating position.
- Child restraint system is compliant with safety standard. We recommend the child restraint system with the UN-ECE R44 or the regulations of the subject countries. Look for the approval mark on the system and the manufacturer's statement of compliance on the box.

☒ Selecting a Child Restraint System

Installation of a lower anchorage*-compatible child restraint system is simple.

Lower anchorage-compatible child restraint systems have been developed to simplify the installation process and reduce the likelihood of injuries caused by incorrect installation.

* Not available on all models

■ The Recommended Child Restraint Systems for EU Countries

Various types of child restraint systems are available. Not all types are suitable for your vehicle. Please refer to the table below to select which category of child restraint system can be used on each seating position.

1.4 L engine, 1.8 L engine, and diesel engine models

Mass group		Seating position			
		Front passenger		Rear passenger	
		Passenger front airbag ON/OFF switch position		Rear outboard	Rear centre
OFF	ON				
group 0	Up to 10 kg	U*1	X	U	X
group 0+	Up to 13 kg	U*1	X	IL (Honda BABY-SAFE ISOFIX, Honda iZi Kid X3 ISOFIX) or U	Honda BABY-SAFE
group I	9 kg to 18 kg	U*1	UF*1	IUF (Size class A, B1, B) or IL (Honda iZi Kid X3 ISOFIX) or U	Honda Eclipse
group II	15 kg to 25 kg	U*1	UF*1	L (Honda KID FIX) or U	X
group III	22 kg to 36 kg	U*1	UF*1	L (Honda KID FIX) or U	X

- IL: Suitable for particular ISO FIX child restraint system (CRS) given in this list.
- IUF: Suitable for forward-facing ISOFIX child restraints system of universal category approved for use in this mass group. For Group I, the front facing genuine Honda ISO FIX child restraint system is available from a dealer.
- L: Suitable for particular child restraint systems given in this table. These restraints may be of the “specific vehicle,” “restricted,” or “semi-universal” category.
- U: Suitable for “universal” category restraints approved for use in this mass group.
- UF: Suitable for front facing “universal” category restraints approved for use in this mass group.
- X: Seat position not suitable for children in this mass group.
- *1: Move the front seat to its rearmost position and adjust the front seat-back angle to the most upright position.

A size class is specified for some child restraint systems. Make sure to check the size class as indicated on the manufacturer’s instructions, package, and labels of the child restraint.

The particular child restraints in the table are Honda Genuine Parts. They are available from your dealer.

For a correct installation, please refer to the Child Restraint Instruction Manual.

2.0 L engine models

Mass group		Seating position		
		Front passenger		Rear passenger
		Passenger front airbag ON/OFF switch position		L/R Side
OFF	ON			
group 0	Up to 10 kg	X	X	U
group 0+	Up to 13 kg	L ^{*2,*3}	X	IL (Honda BABY-SAFE ISOFIX) or U
group I	9 kg to 18 kg	UF ^{*1,*2}	UF ^{*1,*2}	IUF (Size class A, B1, B) or U
group II	15 kg to 25 kg	UF ^{*1,*2}	UF ^{*1,*2}	U
group III	22 kg to 36 kg	UF ^{*1,*2}	UF ^{*1,*2}	U

- IL: Suitable for particular ISOFIX child restraint system (CRS) given in this list.
- IUF: Suitable for forward-facing ISOFIX child restraints system of universal category approved for use in this mass group.
- L: Suitable for particular child restraint systems given in this list. These restraints may be of the “specific vehicle,” “restricted,” or “semi-universal” category.
- U: Suitable for “universal” category restraints approved for use in this mass group.
- UF: Suitable for front facing “universal” category restraints approved for use in this mass group.
- X: Seat position not suitable for children in this mass group.
- *1: Seat-back angle to the upright position (Front most lock position).
- *2: Move the front seat to its slide rail rearmost position.
- *3: Honda BABY SAFE is able to equipped for rear facing.

A size class is specified for some child restraint systems. Make sure to check the size class as indicated on the manufacturer’s instructions, package, and labels of the child restraint.

The particular child restraints in the table are Honda Genuine Parts. They are available from your dealer. For a correct installation, please refer to the Child Restraint Instruction Manual.

Installing a Lower Anchorage-Compatible Child Restraint System

A lower anchorage-compatible child restraint system can be installed in either of the two rear outer seats. A child restraint system is attached to the lower anchorages with either the rigid or flexible type of connectors.

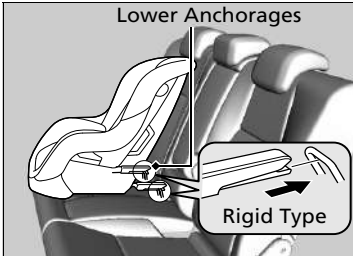
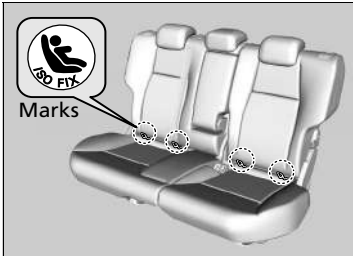

1. Locate the lower anchorages under the marks.

2. Place the child restraint system on the vehicle seat then attach the child restraint system to the lower anchorages according to the instructions that came with the child restraint system.

- When installing the child restraint system, make sure that the lower anchorages are not obstructed by the seat belt or any other object.

Installing a Lower Anchorage-Compatible Child Restraint System

Some child restraint systems come with optional guide-cups, which avoid possible damage to the seat surface. Follow the manufacturer's instructions when using the guide-cups, and attach them to the lower anchorages as shown in the image.

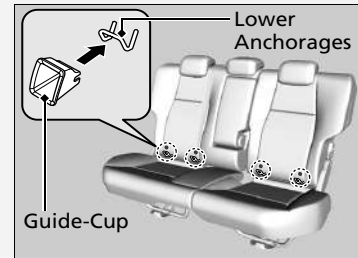

Continued

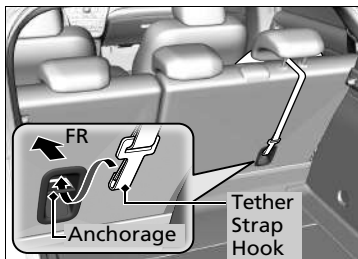
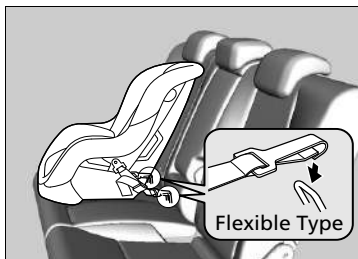

3. Remove the luggage area cover*.

► Luggage Area Cover* P. 213

4. Raise the head restraint to its highest position, then route the tether strap between the head restraint legs, and secure the tether strap hook onto the anchorage.

5. Tighten the tether strap as instructed by the child restraint system manufacturer.

6. Make sure the child restraint system is firmly secured by rocking it forward and back and side to side; little movement should be felt.

7. Make sure any unused seat belt that a child can reach is buckled.

► Installing a Lower Anchorage-Compatible Child Restraint System

WARNING: Never use a hook that does not come with a Top Tether anchor symbol when securing an installed child restraint system.

For your child's safety, when using a child restraint system installed using the lower anchorage system, make sure that the child restraint system is properly secured to the vehicle. A child restraint system that is not properly secured will not adequately protect a child in a crash and may cause injury to the child or other vehicle occupants.

The flexible type may not be available in your country.

■ Installing a Child Restraint System with a Lap/Shoulder Seat Belt

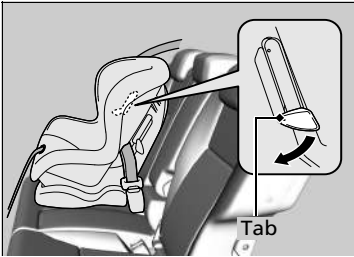

1. Place the child restraint system on the vehicle seat.
2. Route the seat belt through the child restraint system according to the child restraint system manufacturer's instructions, and insert the latch plate into the buckle.
 - ▶ Insert the latch plate fully until it clicks.
3. Push down the tab. Route the shoulder part of the belt into the slit at the side of the restraint.
4. Grab the shoulder part of the belt near the buckle, and pull up to remove any slack from the lap part of the belt.
 - ▶ When doing this, place your weight on the child restraint system and push it into the vehicle seat.
5. Position the belt properly and push up the tab. Make sure the belt is not twisted.
 - ▶ When pushing up the tab, pull up the upper shoulder part of the belt to remove any slack from the belt.

▣ Installing a Child Restraint System with a Lap/Shoulder Seat Belt

A child restraint system that is not properly secured will not adequately protect a child in a crash and may cause injury to the child or other vehicle occupants.

Continued

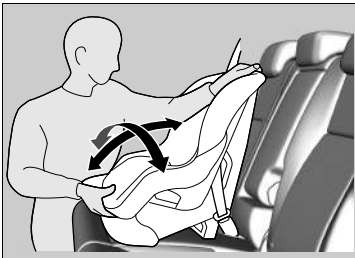

6. Make sure the child restraint system is firmly secured by rocking it forward and back and side to side; little movement should be felt.
7. Make sure any unused seat belt that a child can reach is buckled.

Except European models

If your child restraint system does not come with a mechanism that secures the belt, install a locking clip on the seat belt.

After going through the step 1 and 2, pull up the shoulder part of the belt and make sure there is no slack in the lap portion.

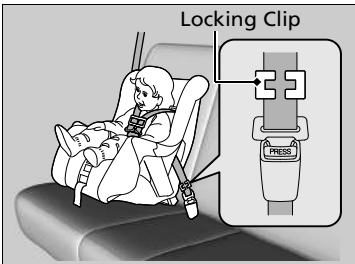

3. Tightly grasp the belt near the latch plate. Pinch both parts of the belt together so they do not slip through the latch plate. Unbuckle the seat belt.
4. Install the locking clip as shown in the image. Position the clip as close as possible to the latch plate.
5. Insert the latch plate into the buckle. Go to step 6 and 7.

Adding Security with a Tether

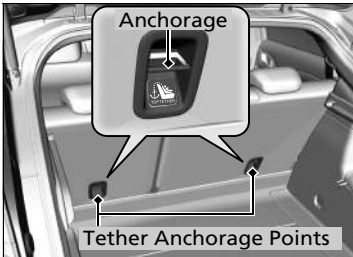

A tether anchorage point is provided behind each rear outer seating position. A child restraint system that is installed with a seat belt and comes with a tether can use the tether for additional security.

1. Locate the appropriate tether anchorage point.
2. Remove the luggage area cover*.
 - **Luggage Area Cover*** P. 213
3. Raise the head restraint to its highest position, then route the tether strap through the head restraint legs. Make sure the strap is not twisted.
4. Secure the tether strap hook onto the anchorage.
5. Tighten the tether strap as instructed by the child restraint system manufacturer.

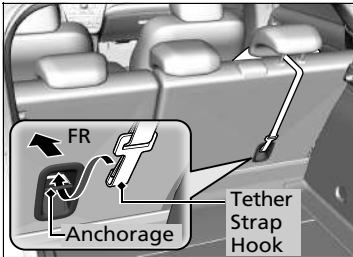

Adding Security with a Tether

WARNING: Child restraint anchorages are designed to withstand only those loads imposed by correctly fitted child restraints. Under no circumstances are they to be used for adult seat belts, harnesses or for attaching other items or equipment to the vehicle.

Since a tether can provide additional security to the lap/shoulder seat belt installation, we recommend using a tether whenever one is available.

* Not available on all models

Safety of Larger Children

■ Protecting Larger Children

The following pages give instructions on how to check proper seat belt fit, what kind of booster seat to use if one is needed, and important precautions for a child who must sit in front.

■ Checking Seat Belt Fit

When a child is too big for a child restraint system, secure the child in a rear seat using the lap/shoulder seat belt. Have the child sit upright and all the way back, then answer the following questions.

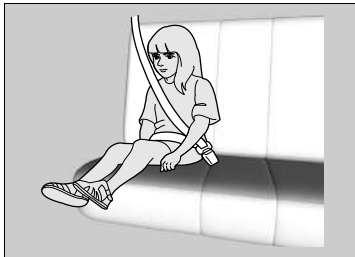

■ Checklist

- Do the child's knees bend comfortably over the edge of the seat?
- Does the shoulder belt cross between the child's neck and arm?
- Is the lap part of the seat belt as low as possible, touching the child's thighs?
- Will the child be able to stay seated like this for the whole trip?

If you answer yes to all these questions, the child is ready to wear the lap/shoulder seat belt correctly. If you answer no to any question, the child needs to ride on a booster seat until the seat belt fits properly without a booster seat.

▶ Safety of Larger Children

⚠ WARNING

Allowing a child age 12 or under to sit in front can result in injury or death if the passenger's front airbag inflates.

If a larger child must ride in front, move the vehicle seat as far to the rear as possible, have the child sit up properly and wear the seat belt properly, using a booster seat if needed.

Booster Seats



If a lap/shoulder seat belt cannot be used properly, position the child in a booster seat in a rear seating position. For the child's safety, check that the child meets the booster seat manufacturer's recommendations.

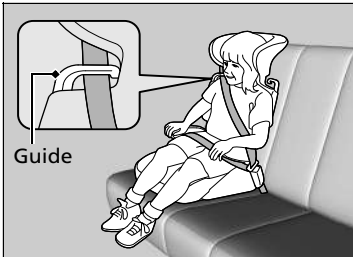

A back-rest is available for a specific booster seat. Install the back-rest to the booster seat and adjust it to the vehicle seat according to the booster seat manufacturer's instructions. Make sure the seat belt is properly routed through the guide at the shoulder of the back-rest and the belt does not touch and cross the child's neck.

Booster Seats

When installing a booster seat, make sure to read the instructions that came with it, and install the seat accordingly. There are high- and low-type booster seats. Choose a booster seat that allows the child to wear the seat belt correctly.

Continued

■ Protecting Larger Children - Final Checks

Your vehicle has a rear seat where children can be properly restrained. If you ever have to carry a group of children, and a child must ride in front:

- Make sure you read and fully understand the instructions and safety information in this manual.
- Move the front passenger seat as far back as possible.
- Have the child sit upright and well back in the seat.
- Check that the seat belt is properly positioned so that the child is secure in the seat.

■ Monitoring child passengers

We strongly recommend that you keep an eye on child passengers. Even older, more mature children sometimes need to be reminded to fasten their seat belts and sit up properly.

Carbon Monoxide Gas

The engine exhaust from this vehicle contains carbon monoxide, a colourless, odourless, and highly toxic gas. As long as you properly maintain your vehicle, carbon monoxide gas will not get into the interior.

■ Have the exhaust system inspected for leaks whenever

- The exhaust system is making an unusual noise.
- The exhaust system may have been damaged.
- The vehicle is raised for an oil change.

When you operate a vehicle with the tailgate open, airflow can pull exhaust gas into the interior and create a hazardous condition. If you must drive with the tailgate open, open all the windows and set the climate control system as shown below.

1. Select the fresh air mode.
2. Select the  mode.
3. Set the fan speed to high.
4. Set the temperature control to a comfortable setting.

Adjust the climate control system in the same manner if you sit in your parked vehicle with the engine running.

Carbon Monoxide Gas

⚠ WARNING

Carbon monoxide gas is toxic. Breathing it can cause unconsciousness and even kill you.

Avoid any enclosed areas or activities that expose you to carbon monoxide.

An enclosed area such as a garage can quickly fill up with carbon monoxide gas.

Do not run the engine with the garage door closed. Even when the garage door is open, drive out of the garage immediately after starting the engine.

Label Locations

These labels are in the locations shown. They warn you of potential hazards that can cause serious injury or death. Read these labels carefully.

If a label comes off or becomes hard to read, contact a dealer for a replacement.

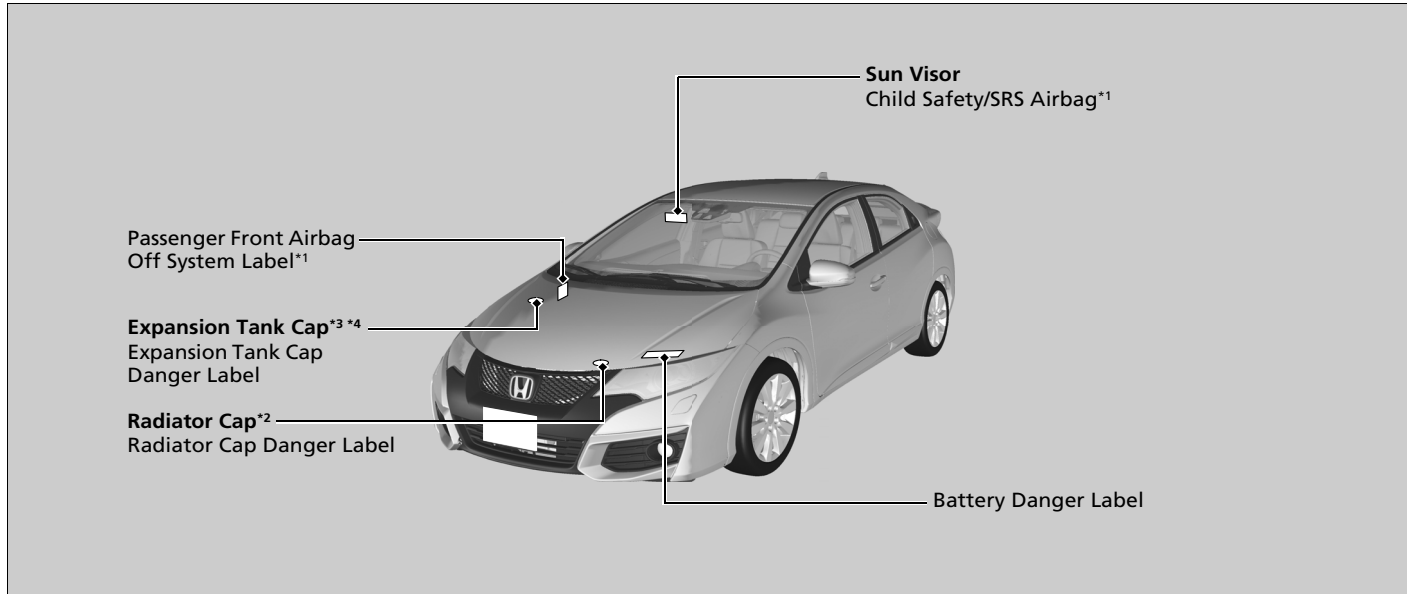

*1: Left-hand drive models shown. For the right-hand drive models, these labels are located at the symmetrically opposite to the left-hand drive model.

*2: 1.4 L engine and 1.8 L engine models

*3: Diesel models

*4: 2.0 L engine models





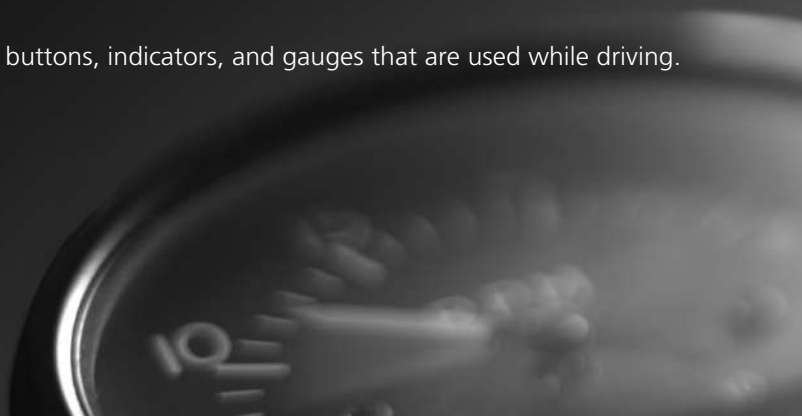



Instrument Panel

This chapter describes the buttons, indicators, and gauges that are used while driving.







Indicators	82
i-Multi-Information Display Warning and Information Messages.....	103
Gauges and i-Multi-Information Display	
Gauges.....	119
i-Multi-Information Display	120









Indicators

Indicator	Name	On/Blinking	Explanation	Message
 (Red)	Parking Brake and Brake System Indicator (Red)	<ul style="list-style-type: none"> • Comes on for a few seconds when you turn the ignition switch to ON ^{*1}, then goes off if the parking brake has been released. • Comes on when the parking brake is applied and goes off when it is released. • Comes on when the brake fluid level is low. • Comes on if there is a problem with the brake system. • The beeper sounds and the indicator comes on if you drive with the parking brake not fully released. 	<ul style="list-style-type: none"> • Comes on while driving - Make sure the parking brake is released. Check the brake fluid level. <ul style="list-style-type: none"> ➤ What to do when the indicator comes on while driving P. 588 • Comes on along with the ABS indicator - Have your vehicle checked by a dealer. <ul style="list-style-type: none"> ➤ If the Brake System Indicator (Red) Comes On P. 588 	 
 (Amber)	Brake System Indicator (Amber)	<ul style="list-style-type: none"> • Comes on for a few seconds when you turn the ignition switch to ON ^{*1}, then goes off. • Comes on if there is a problem with a system related to braking other than the conventional brake system. 	<ul style="list-style-type: none"> • Stays on constantly - Have your vehicle checked by a dealer. 	
		<ul style="list-style-type: none"> • Comes on if there is a problem with the City-Brake Active system*. 	<ul style="list-style-type: none"> • Comes on along with the CTBA indicator - The City-Brake Active system does not activate. Have your vehicle checked by a dealer. <ul style="list-style-type: none"> ➤ City-Brake Active system* P. 434 	







*1: Models with the keyless access system have an **ENGINE START/STOP** button instead of an ignition switch.

Indicator	Name	On/Blinking	Explanation	Message
	Low Oil Pressure Indicator	<ul style="list-style-type: none"> • Comes on when you turn the ignition switch to ON [II]*1, and goes off when the engine starts. • Comes on when the engine oil pressure is low. 	<ul style="list-style-type: none"> • Comes on while driving - Immediately stop in a safe place. <ul style="list-style-type: none"> ▶ If the Low Oil Pressure Indicator Comes On P. 587 Diesel models <ul style="list-style-type: none"> ▶ Starting the Engine P. 382, 385 	
	Malfunction Indicator Lamp	<ul style="list-style-type: none"> • Comes on when you turn the ignition switch to ON [II]*1, and goes off when the engine starts, or after several seconds if the engine did not start. • Comes on if there is a problem with the emissions control systems. • Blinks when a misfire in the engine's cylinders is detected. 	<ul style="list-style-type: none"> • Comes on while driving - Have your vehicle checked by a dealer. • Shows the self-testing condition of the diagnostics of the emission control system. • Blinks while driving - Stop in a safe place where there are no flammable objects. Stop the engine for 10 minutes or more, and wait for it to cool down. Then, take the vehicle to a dealer. <ul style="list-style-type: none"> ▶ If the Malfunction Indicator Lamp Comes On or Blinks P. 588 Diesel models with fuel system primer <ul style="list-style-type: none"> • Stays on after the fuel tank has been run dry - Prime the fuel system. <ul style="list-style-type: none"> ▶ Priming the Fuel System P. 603 	

*1: Models with the keyless access system have an **ENGINE START/STOP** button instead of an ignition switch.



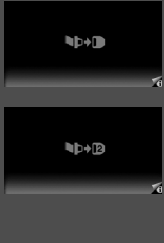

Indicator	Name	On/Blinking	Explanation	Message
	Charging System Indicator	<ul style="list-style-type: none"> Comes on when you turn the ignition switch to ON *1, and goes off when the engine starts. Comes on when the battery is not charging. 	<ul style="list-style-type: none"> Comes on while driving - Turn off the climate control system and rear demister to reduce electricity consumption. <ul style="list-style-type: none"> ➤ If the Charging System Indicator Comes On P. 587 	
	Shift Lever Position Indicator*	<ul style="list-style-type: none"> Indicates the current shift lever position. 	<ul style="list-style-type: none"> ➤ Shifting P. 390 	
	Transmission Indicator*	<ul style="list-style-type: none"> Comes on for a few seconds when you turn the ignition switch to ON *1, then goes off. Blinks if the transmission system has a problem. 	<ul style="list-style-type: none"> Blinks while driving - Avoid sudden starts and acceleration and have your vehicle checked by a dealer immediately. 	

*1: Models with the keyless access system have an **ENGINE START/STOP** button instead of an ignition switch.





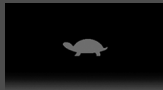

Indicator	Name	On/Blinking	Explanation	Message
	M (sequential shift mode) Indicator/Gear Position Indicator*	<ul style="list-style-type: none"> • Comes on when the manual sequential shift mode is applied. • Blinks if the transmission system has a problem. 	 Sequential Shift Mode P. 392	
	Seat Belt Reminder Indicator	<ul style="list-style-type: none"> • Comes on if you are not wearing a seat belt when you turn the ignition switch to ON *1. • If the front passenger is not wearing a seat belt, the indicator comes on about a few seconds later. • Blinks while driving if either you or the front passenger has not fastened a seat belt. The beeper sounds and the indicator blinks at regular intervals. 	<ul style="list-style-type: none"> • The beeper stops and the indicator goes off when you and the front passenger fasten their seat belts. • Stays on after you or the front passenger has fastened the seat belt - A detection error may have occurred in the sensor. Have your vehicle checked by a dealer.  Seat Belt Reminder P. 39	

Instrument Panel







* 1: Models with the keyless access system have an **ENGINE START/STOP** button instead of an ignition switch.

Indicator	Name	On/Blinking	Explanation	Message
	Low Fuel Indicator	<ul style="list-style-type: none"> • Comes on when the fuel reserve is running low (approximately 7.5 Litres/ 1.65 Imp gal left), along with a warning message on the i-multi-information display. • Blinks if there is a problem with the fuel gauge. • A figure on the warning message shows the estimated distance you can travel on the remaining fuel. 	<ul style="list-style-type: none"> • Comes on - Refuel your vehicle as soon as possible. The estimated distance you can travel on the remaining fuel appears on the i-multi-information display. <ul style="list-style-type: none"> ➤ Diesel models with fuel system primer • If the fuel tank has been run dry, prime the fuel system. <ul style="list-style-type: none"> ➤ Priming the Fuel System P. 603 • Blinks - Have your vehicle checked by a dealer. 	
		<ul style="list-style-type: none"> ➤ Diesel models without fuel system primer • Appears when the Range on the multi-information display reaches to 0. 	<ul style="list-style-type: none"> • Maximum vehicle speed is restricted. • Refuel your vehicle as soon as possible. The vehicle speed limit will be released when refueling 10 Litres (2.2 Imp gal) or more. <ul style="list-style-type: none"> ➤ Refueling P. 453 	
		<ul style="list-style-type: none"> ➤ Diesel models without fuel system primer • Appears when the remaining fuel is nearly-empty. 	<ul style="list-style-type: none"> • The vehicle will stop soon. • You cannot restart the engine. Immediately refuel your vehicle. <ul style="list-style-type: none"> ➤ Refueling P. 453 	











*1: Models with the keyless access system have an **ENGINE START/STOP** button instead of an ignition switch.

Indicator	Name	On/Blinking	Explanation	Message
	Glow Plugs Indicator*	<ul style="list-style-type: none"> • Comes on for a few seconds when you turn the ignition switch to ON ^{*1}, then goes off. • Comes on for a while when you turn the ignition switch to ON ^{*1} under the extremely low engine coolant temperature condition, then goes off. 	<ul style="list-style-type: none"> • Stays on - The engine is cold. Do not start the engine until the indicator goes off. <ul style="list-style-type: none"> ▶ Starting the Engine P. 382, 385 • If you still find it hard to start the engine, have your vehicle inspected by your dealer. 	
	Anti-lock Brake System (ABS) Indicator	<ul style="list-style-type: none"> • Comes on for a few seconds when you turn the ignition switch to ON ^{*1}, then goes off. • If it comes on at any other time, there is a problem with the ABS. 	<ul style="list-style-type: none"> • Stays on constantly - Have your vehicle checked by a dealer. With this indicator on, your vehicle still has normal braking ability but no anti-lock function. <ul style="list-style-type: none"> ▶ Anti-lock Brake System (ABS) P. 432 	









* 1: Models with the keyless access system have an **ENGINE START/STOP** button instead of an ignition switch.

Indicator	Name	On/Blinking	Explanation	Message
	Supplemental Restraint System Indicator	<ul style="list-style-type: none"> • Comes on for a few seconds when you turn the ignition switch to ON ^{*1}, then goes off. • Comes on if a problem with any of the following is detected: <ul style="list-style-type: none"> - Supplemental restraint system - Side airbag system - Side curtain airbag system - Seat belt tensioner 	<ul style="list-style-type: none"> • Stays on constantly or does not come on at all - Have your vehicle checked by a dealer. 	
	Passenger Front Airbag On/Off Indicators	<ul style="list-style-type: none"> • Both indicators come on for a few seconds when you turn the ignition switch to ON ^{*1}, then goes off after a system check up. <p>When the passenger front airbag is active: The on indicator comes back on and remains on for about 60 seconds.</p> <p>When the passenger front airbag is inactive: The off indicator comes back on and stays on. This is a reminder that the passenger front airbag is deactivated.</p>	<p> Passenger Front Airbag Off System P. 53</p>	







*1: Models with the keyless access system have an **ENGINE START/STOP** button instead of an ignition switch.

Indicator	Name	On/Blinking	Explanation	Message
	Vehicle Stability Assist (VSA) System Indicator	<ul style="list-style-type: none"> Comes on for a few seconds when you turn the ignition switch to ON *1, then goes off. Blinks when VSA is active. Comes on if there is a problem with the VSA system or hill start assist system. 	<ul style="list-style-type: none"> Stays on constantly - Have your vehicle checked by a dealer. <ul style="list-style-type: none">  Vehicle Stability Assist (VSA) System P. 422 	
	Vehicle Stability Assist (VSA) OFF Indicator	<ul style="list-style-type: none"> Comes on for a few seconds when you turn the ignition switch to ON *1, then goes off. Comes on when you deactivate VSA. 	<ul style="list-style-type: none">  VSA On and Off P. 423 	
	Door and Tailgate Open Indicator	<ul style="list-style-type: none"> Comes on for a few seconds when you turn the ignition switch to ON *1, then goes off. Comes on if any door or the tailgate is not completely closed. The beeper sounds and the indicator comes on if any door or the tailgate is opened while driving. 	<ul style="list-style-type: none"> Goes off when all doors and the tailgate are closed. 	







*1: Models with the keyless access system have an **ENGINE START/STOP** button instead of an ignition switch.

Indicator	Name	On/Blinking	Explanation	Message
	Electric Power Steering (EPS) System Indicator	<ul style="list-style-type: none"> Comes on when you turn the ignition switch to ON ^{*1}, and goes off when the engine starts. Comes on if there is a problem with the EPS system. 	<ul style="list-style-type: none"> Stays on constantly or does not come on at all - Have your vehicle checked by a dealer. <ul style="list-style-type: none"> ➤ If the Electric Power Steering (EPS) System Indicator Comes On P. 589 	
	Low Tyre Pressure/Deflation Warning System Indicator	<ul style="list-style-type: none"> Comes on for a few seconds when you turn the ignition switch to ON ^{*1}, then goes off. May come on briefly if the ignition switch is turned to ON ^{*1} and the vehicle is not moved within 45 seconds, to indicate the calibration process is not yet complete. Comes on and stays on when: <ul style="list-style-type: none"> - One or more tyres' pressures are determined to be significantly low. - The system has not been calibrated. Blinks for about one minute, and then stays on if there is a problem with the deflation warning system, or when a compact spare tyre[*] is temporarily installed. 	<ul style="list-style-type: none"> Comes on while driving - Stop in a safe place, check tyre pressures, and inflate the tyre(s) if necessary. Stays on after the tyres are inflated to the recommended pressures - The system needs to be calibrated. <ul style="list-style-type: none"> ➤ Deflation Warning System Calibration P. 428 Blinks and remains on - Have your vehicle checked by a dealer. If the vehicle is fitted with a compact spare, get your regular tyre repaired or replaced and put back on your vehicle as soon as you can. 	 







*1: Models with the keyless access system have an **ENGINE START/STOP** button instead of an ignition switch.

Indicator	Name	On/Blinking	Explanation	Message
	System Message Indicator	<ul style="list-style-type: none"> • Comes on for a few seconds when you turn the ignition switch to ON *1, then goes off. • Comes on along with a beep when a problem is detected. A system message on the i-multi-information display appears at the same time. 	<ul style="list-style-type: none"> • While the indicator is on, press the  (display/information) button to see the message again. • Refer to the Indicators information in this chapter when a system message appears on the i-multi-information display. Take the appropriate action for the message. • The i-multi-information display does not return to the normal screen unless the warning is cancelled, or the  button is pressed. 	—
	Turn Signal and Hazard Warning Indicators	<ul style="list-style-type: none"> • Blink when you operate the turn signal lever. • Blink along with all turn signals if you press the hazard warning button. • Blink along with all turn signals if you depress the brake pedal while the high speed driving. 	<ul style="list-style-type: none"> • Does not blink or blinks rapidly - A turn signal light bulb has blown. Change the bulb immediately. <ul style="list-style-type: none"> ➤ Replacing Light Bulbs P. 519, 521 ➤ Emergency Stop Signal P. 439 	—
	High Beam Indicator	<ul style="list-style-type: none"> • Comes on when the high beam headlights are on. 	—	—

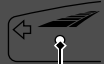
*1: Models with the keyless access system have an **ENGINE START/STOP** button instead of an ignition switch.





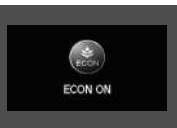

Indicator	Name	On/Blinking	Explanation	Message
	Lights On Indicator	<ul style="list-style-type: none"> Comes on whenever the light switch is on, or in AUTO* when the exterior lights are on. 	<ul style="list-style-type: none"> If you remove the key from the ignition switch*¹ while the lights are on, a chime sounds when the driver's door is opened. 	—
	Front Fog Light Indicator*	<ul style="list-style-type: none"> Comes on when the front fog lights are on. 	—	—
	Rear Fog Light Indicator	<ul style="list-style-type: none"> Comes on when the rear fog light is on. 	—	—
	Immobilizer System Indicator	<ul style="list-style-type: none"> Comes on briefly when you turn the ignition switch to ON ^{*1}, then goes off. Comes on if the immobilizer system cannot recognize the key information. 	<ul style="list-style-type: none"> Blinks - You cannot start the engine. Turn the ignition switch to LOCK ^{*1}, pull the key out, and then insert the key and turn it to ON ^{*1} again. Repeatedly blinks - The system may be malfunctioning. Have your vehicle checked by a dealer. Do not attempt to alter this system or add other devices to it. Electrical problems can occur. 	—

*1: Models with the keyless access system have an **ENGINE START/STOP** button instead of an ignition switch.









Indicator	Name	On/Blinking	Explanation	Message
<p>Except 2.0 L engine models</p>  <p>Indicator</p> <p>2.0 L engine models</p>  <p>Indicator</p>	<p>Security System Alarm Indicator*</p>	<ul style="list-style-type: none"> Blinks when the security system alarm has been set. 	<p>➤ Security System Alarm* P. 162</p>	
	<p>Keyless Access System Indicator*</p>	<ul style="list-style-type: none"> Comes on for a few seconds when you change the power mode to ON, then goes off. Comes on as soon as a problem is detected in the keyless access system or keyless starting system. 	<ul style="list-style-type: none"> Have your vehicle checked by a dealer. 	
	<p>ECON Mode Indicator*</p>	<ul style="list-style-type: none"> Comes on for a few seconds when you turn the ignition switch to ON ^{*1}, then goes off. Comes on when ECON mode is on. 	<p>➤ ECON Button* P. 402</p>	

*1: Models with the keyless access system have an **ENGINE START/STOP** button instead of an ignition switch.

* Not available on all models

Indicator	Name	On/Blinking	Explanation	Message
	Shift Up Indicator	<ul style="list-style-type: none"> Comes on briefly when you turn the ignition switch to ON *1, then goes off. Comes on when shifting up is recommended. 	➤ Shift Up/Down Indicators P. 394, 396	—
	Shift Down Indicator	<ul style="list-style-type: none"> Comes on briefly when you turn the ignition switch to ON *1, then goes off. Comes on when shifting down is recommended. 	➤ Shift Up/Down Indicators P. 394, 396	—
	Cruise Main Indicator*	<ul style="list-style-type: none"> Comes on when you press the MAIN button. If a different indicator comes on, subsequently press the LIM button. 	➤ Cruise Control * P. 404	—
	Adjustable Speed Limiter Indicator*	<ul style="list-style-type: none"> Comes on when you press the MAIN button. If a different indicator comes on, subsequently press the LIM button. 	➤ Adjustable Speed Limiter * P. 407	—
	Cruise Control and Adjustable Speed Limiter Set Speed Indicator*	<ul style="list-style-type: none"> Comes on when you have set a speed for cruise control or for adjustable speed limiter. 	➤ Cruise Control * P. 405 ➤ Adjustable Speed Limiter * P. 408	—







*1: Models with the keyless access system have an **ENGINE START/STOP** button instead of an ignition switch.

Indicator	Name	On/Blinking	Explanation	Message
	High Beam Support System Indicator*	<ul style="list-style-type: none"> • Comes on for a few seconds when you turn the ignition switch to ON ^{*1}, then goes off. • Comes on when all the operating conditions of the high beam support system are met. 	<ul style="list-style-type: none"> ➤ High Beam Support System* P. 180 	
	Auto Idle Stop Indicator (Green)*	<ul style="list-style-type: none"> • Comes on when Auto Idle Stop is in operation. The engine automatically shuts off. • Blinks when the ambient conditions may cause the windows to fog up. • Blinks when the ambient conditions may become different from the climate control settings you have selected. 	<ul style="list-style-type: none"> ➤ Auto Idle Stop P. 398 • Depress the clutch pedal. The engine automatically restarts. ➤ Auto Idle Stop P. 398 	
	Auto Idle Stop System Indicator (Amber)*	<ul style="list-style-type: none"> • Comes on for a few seconds when you turn the ignition switch to ON ^{*1}, then goes off. • Comes on if there is a problem with the Auto Idle Stop system. • Comes on when Auto Idle Stop cannot activate because there is a problem with the battery or charging system. 	<ul style="list-style-type: none"> • Stays on constantly or does not come on at all - Have your vehicle checked by a dealer. 	  (Amber)





Instrument Panel

*1: Models with the keyless access system have an **ENGINE START/STOP** button instead of an ignition switch.

* Not available on all models







Indicator	Name	On/Blinking	Explanation	Message
	Forward Collision Warning Indicator*	<ul style="list-style-type: none"> • Comes on for a few seconds when you turn the ignition switch to ON ^{*1}, then goes off. • Comes on when you have customized forward collision warning system to turn off. • Comes on if there is a problem with the system. 	<ul style="list-style-type: none"> • Stays on constantly without the system off - Have your vehicle checked by a dealer. 	 (White)
		<ul style="list-style-type: none"> • Comes on when the system shuts itself off. 	<ul style="list-style-type: none"> • Stays on - The temperature inside the camera is too high. The system activates when the temperature inside the system cools down.  Automatic shutoff P. 413 	 (Amber)
			<ul style="list-style-type: none"> • Stays on - The area around the camera is blocked by dirt, mud, etc. Stop your vehicle in a safe place, and wipe it off with a soft cloth. • Have your vehicle checked by a dealer if the indicator and message come back on after you cleaned the area around the camera.  Automatic shutoff P. 413 	

*1: Models with the keyless access system have an **ENGINE START/STOP** button instead of an ignition switch.



Indicator	Name	On/Blinking	Explanation	Message
	Lane Departure Warning Indicator*	<ul style="list-style-type: none"> • Comes on for a few seconds when you turn the ignition switch to ON *¹, then goes off. • Comes on if there is a problem with the lane departure warning system. 	<ul style="list-style-type: none"> • Stays on constantly - Have your vehicle checked by a dealer. 	
		<ul style="list-style-type: none"> • Comes on when the system shuts itself off. 	<ul style="list-style-type: none"> • Stays on - The temperature inside the camera is too high. Use the climate control system to cool down the camera. The system activates when the temperature inside the camera cools down. <ul style="list-style-type: none"> ▶ Lane Departure Warning Camera P. 416 	
			<ul style="list-style-type: none"> • Stays on - The area around the camera is blocked by dirt, mud, etc. Stop your vehicle in a safe place, and wipe it off with a soft cloth. • Have your vehicle checked by a dealer if the indicator and message come back on after you cleaned the area around the camera. <ul style="list-style-type: none"> ▶ Lane Departure Warning Camera P. 416 	

*1: Models with the keyless access system have an **ENGINE START/STOP** button instead of an ignition switch.



* Not available on all models

Indicator	Name	On/Blinking	Explanation	Message
	Blind Spot Information Indicator*	<ul style="list-style-type: none"> Comes on for a few seconds when you turn the ignition switch to ON ^{*1}, then goes off. Stays on while the blind spot information system is turned off. 	—	
		<ul style="list-style-type: none"> Comes on when mud, snow, or ice accumulates in the vicinity of sensor. 	<ul style="list-style-type: none"> Comes on while driving - Remove the obstacle in the vicinity of sensor.  Blind Spot Information System* P. 425 	
		<ul style="list-style-type: none"> Comes on if there is a problem with the system. 	<ul style="list-style-type: none"> Comes on while driving - Have your vehicle checked by a dealer. 	



*1: Models with the keyless access system have an **ENGINE START/STOP** button instead of an ignition switch.

Indicator	Name	On/Blinking	Explanation	Message
<p style="text-align: center; font-size: 24pt; font-weight: bold;">CTBA</p>	<p style="text-align: center;">City-Brake Active System (CTBA) Indicator*</p>	<ul style="list-style-type: none"> • Comes on for a few seconds when you turn the ignition switch to ON *, then goes off. 	—	—
		<ul style="list-style-type: none"> • Goes off when you have customized the City-Brake Active system to turn on. • Comes on when you have customized the City-Brake Active system to turn off. 	<ul style="list-style-type: none"> ➤ City-Brake Active system* P. 434 ➤ Customized Features P. 131 	—
		<ul style="list-style-type: none"> • Comes on when the area around the laser sensor, which is located in the upper part of the windscreen, is covered with obstacles, such as dirt, ice and frost. • May come on when driving in bad weather (rain, fog, snow). 	<ul style="list-style-type: none"> • Remove dirt or any obstacles using the washer and wipers. • Stop your vehicle in a safe place and wipe away dirt or any obstacles covering the area around the laser sensor on the windscreen. ➤ City-Brake Active system* P. 434 • The system resumes when obstacles are removed. 	
		<ul style="list-style-type: none"> • Comes on when snow is accumulated on the bonnet. 	<ul style="list-style-type: none"> • Stop your vehicle in a safe place and remove snow from the bonnet. 	

* Not available on all models

Indicator	Name	On/Blinking	Explanation	Message
<p style="text-align: center; font-size: 2em; font-weight: bold;">CTBA</p>	<p>City-Brake Active System (CTBA) Indicator*</p>	<ul style="list-style-type: none"> • May come on when the temperatures of the area around the laser sensor are high. 	<ul style="list-style-type: none"> • Use the climate control system to cool down the area around the laser sensor. • The system resumes when the temperatures of the area around the laser sensor go down. 	
		<ul style="list-style-type: none"> • Comes on along with the brake system indicator (amber) if there is a problem with the system. 	<ul style="list-style-type: none"> • The system does not activate. Have your vehicle checked by a dealer. 	

2.0 L engine models



Indicator	Name	On/Blinking	Explanation	Message
	Gear Position Indicator	<ul style="list-style-type: none"> Indicates 1st to 6th gear position. 	<ul style="list-style-type: none"> The gear position is not displayed when the vehicle is stopped (approximately less than 3 km/h or 2 mph*) or when the lever is in N position. If you shift gears very slowly, a different gear position may be displayed for a moment. <ul style="list-style-type: none"> ▶ Shifting P. 395 The display can be turned ON/OFF in customized features in i-multi-information. <ul style="list-style-type: none"> ▶ Customized Features P. 131 Under the following conditions, gear positions and frame borders are not displayed. <ul style="list-style-type: none"> - The select lever is in R position. - The display of gear position indicator is turned OFF in customized features. 	—
	+R Indicator	<ul style="list-style-type: none"> Comes on when you press the +R button. 	<ul style="list-style-type: none"> ▶ +R Button* P. 403 	—





* Not available on all models





Indicator	Name	On/Blinking	Explanation	Message
 <p>Indicators</p>	<p>REV Indicators</p>	<ul style="list-style-type: none"> • The indicators start illuminating at both ends according to the engine speed. • The two indicators at the center blink when the engine speed reaches near the tachometer's red zone. In addition, in order to prevent engine over-speed, the indicators flash to notify you of the up-shift timing. 	<ul style="list-style-type: none"> <ul style="list-style-type: none"> ▣ Shifting P. 395 • The display can be turned ON/OFF in customized features in i-multi-information. <ul style="list-style-type: none"> ▣ Customized Features P. 131 	<p>—</p>

i-Multi-Information Display Warning and Information Messages





The following messages appear only on the i-multi-information display. Press the  (display/information) button to see the message again with the system message indicator on.

Message	Condition	Explanation
<p>Models without keyless access system</p> 	<ul style="list-style-type: none"> Appears when you open the driver's door while the ignition key is in ACCESSORY 1. 	<ul style="list-style-type: none"> Turn the ignition switch to LOCK 0, then remove the key.
<p>Models without keyless access system</p> 	<ul style="list-style-type: none"> Appears when you open the driver's door while the ignition key is in LOCK 0. 	<ul style="list-style-type: none"> Remove the key from the ignition switch.

Message	Condition	Explanation
 <p data-bbox="108 348 448 370">Models without navigation system</p> 	<ul style="list-style-type: none"> • Appears if there is a problem with the parking sensor system*. 	<ul style="list-style-type: none"> • Check if the area around the sensor(s) is covered with mud, ice, snow, etc. If the indicator(s) stays on even after you clean the area, have the system checked by a dealer.
 <p data-bbox="108 628 448 650">Models without navigation system</p> 	<ul style="list-style-type: none"> • If there is a problem with any of the sensors, the appropriate sensor indicator(s) comes on in red. 	

Message	Condition	Explanation
	<ul style="list-style-type: none"> Appears when the engine oil level is low while the engine is running. 	<ul style="list-style-type: none"> Appears while driving - Immediately stop in a safe place. <ul style="list-style-type: none"> ► If the Low Oil Level Symbol Appears P. 591
	<ul style="list-style-type: none"> Appears when the engine is running, there is a system problem in the engine oil level sensor. 	<ul style="list-style-type: none"> Have your vehicle checked by a dealer.
	<ul style="list-style-type: none"> Appears if there is a problem with the Daytime Running Lights (DRL) system. 	<ul style="list-style-type: none"> Have your vehicle checked by a dealer. <ul style="list-style-type: none"> ► Daytime Running Lights P. 182
	<ul style="list-style-type: none"> Appears when the vehicle speed reaches the set speed. You can set two different speeds for the alarm. 	<ul style="list-style-type: none"> ► List of customizable options P. 137
	<ul style="list-style-type: none"> Appears if there is a problem with the automatic lighting control system*. 	<ul style="list-style-type: none"> Appears while driving - Manually turn the lights on, and have your vehicle checked by a dealer.

* Not available on all models





Message	Condition	Explanation
	<ul style="list-style-type: none"> Appears once if the outside temperature is below 3°C while the ignition switch is in ON *1. 	<ul style="list-style-type: none"> There is a possibility that the road surface is icy and slippery.
<p>Except 2.0 L engine models</p>  <p>2.0 L engine models</p> 	<ul style="list-style-type: none"> Appears for about 30 seconds when any of the rear seat belts are latched or unlatched. 	<p>➤ Seat Belt Reminder P. 39</p>
	<ul style="list-style-type: none"> Appears when the engine coolant temperature gets abnormally high. 	<p>➤ Overheating P. 583</p>

*1: Models with the keyless access system have an **ENGINE START/STOP** button instead of an ignition switch.

Message	Condition	Explanation
	<ul style="list-style-type: none"> • Appears when there is a problem with the high beam support system*. <p>Models without lane departure warning</p> <ul style="list-style-type: none"> • Appears when the high beam support system* camera lens gets dirty. 	<ul style="list-style-type: none"> • Manually operate the headlight switch. • If you are driving with the high beam headlights when this happens, the headlights are changed to low beams. <ul style="list-style-type: none"> ▶ High Beam Support System* P. 180 <p>Models without lane departure warning</p> <ul style="list-style-type: none"> • Stop in a safe place and clean the camera lens with a soft cloth. • If the message does not disappear after cleaning the lens, have your vehicle checked by a dealer.

* Not available on all models

Models with service reminder system

Message	Condition	Explanation
	<ul style="list-style-type: none"> Appears when any of the service items is required in less than 30 days or by the total estimated driving distance corresponding to the terms of about 30 days. 	<ul style="list-style-type: none"> The remaining distance will be counted down per 10 kilometres/miles. The remaining days will be counted down per day. ➤ Service Reminder System* P. 463
	<ul style="list-style-type: none"> Appears when any of the service items is required in less than 10 days or by the total estimated driving distance corresponding to the terms of about 10 days. 	<ul style="list-style-type: none"> Have the indicated service performed as soon as possible. ➤ Service Reminder System* P. 463
 	<ul style="list-style-type: none"> Appears when the indicated maintenance service is still not done after the remaining time or distance reaches 0. 	<ul style="list-style-type: none"> Your vehicle has passed the service required point. Immediately have the service performed and make sure to reset the service reminder. ➤ Service Reminder System* P. 463

2.0 L engine models without service reminder system

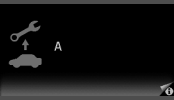
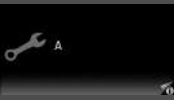
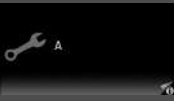
Message	Condition	Explanation
	<ul style="list-style-type: none"> Appears when the scheduled maintenance is due soon. 	<ul style="list-style-type: none"> An early oil change is recommended.
	<ul style="list-style-type: none"> Appears when the scheduled maintenance is due. 	<ul style="list-style-type: none"> Change the engine oil. ➤ Oil Monitor System* P. 468
	<ul style="list-style-type: none"> Appears when the scheduled engine oil change is passed due. 	<ul style="list-style-type: none"> Change the engine oil immediately. ➤ Oil Monitor System* P. 468

* Not available on all models





Models with washer level sensor

Message	Condition	Explanation
	<ul style="list-style-type: none"> Appears when washer fluid gets low. 	<ul style="list-style-type: none"> Refill washer fluid.  Refilling Window Washer Fluid P. 511

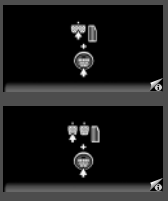

Models with security system or Auto Idle Stop

Message	Condition	Explanation
	<ul style="list-style-type: none"> Appears when the bonnet is opened. 	<ul style="list-style-type: none"> Close the bonnet.





Models with keyless access system

Message	Condition	Explanation
	<ul style="list-style-type: none"> Appears when you close the door with the power mode in ON without the keyless remote inside the vehicle. 	<ul style="list-style-type: none"> Disappears when you bring the keyless remote back inside the vehicle and close the door.
	<ul style="list-style-type: none"> Appears when the keyless remote battery becomes weak. 	<ul style="list-style-type: none"> Replace the battery as soon as possible. <ul style="list-style-type: none"> ➤ Keyless Remote* P. 545
	<ul style="list-style-type: none"> Appears after you unlock and open the driver's door. 	<ul style="list-style-type: none"> ➤ Starting the Engine P. 385
	<ul style="list-style-type: none"> Appears when the steering wheel is locked. 	<ul style="list-style-type: none"> Move the steering wheel left and right while pressing the ENGINE START/STOP button.
	<ul style="list-style-type: none"> Appears if you push the ENGINE START/STOP button to turn the engine off without the shift lever in [P]. 	<ul style="list-style-type: none"> Press the ENGINE START/STOP button twice after moving the shift lever to [P].



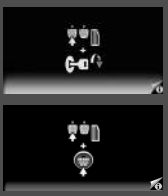

* Not available on all models

Message	Condition	Explanation
	<ul style="list-style-type: none"> • Appears when the power mode is in ACCESSORY. • Appears after the driver's door is opened with the power mode in ACCESSORY. 	<ul style="list-style-type: none"> • Press the ENGINE START/STOP button twice with your foot off the brake pedal (automatic transmission) or the clutch pedal (manual transmission) to change the power mode to VEHICLE OFF (LOCK).
	<ul style="list-style-type: none"> • Appears if the keyless remote's battery is too weak to start the engine or the key is not within operating range. The beeper sounds six times. 	<p>➤ If the Keyless Remote Battery is Weak P. 576</p>
	<ul style="list-style-type: none"> • Appears when the starter system has a problem. 	<ul style="list-style-type: none"> • As a temporary measure, press and hold the ENGINE START/STOP button for 15 seconds while pressing the brake pedal and manually start the engine. Have your vehicle checked by a dealer.





Models with Auto Idle Stop

Message	Condition	Explanation
	<ul style="list-style-type: none"> Appears when the engine does not automatically restart while Auto Idle Stop is in operation. 	<ul style="list-style-type: none"> Manually start the engine. <ul style="list-style-type: none"> ▶ Starting the Engine P. 382, 385
	<ul style="list-style-type: none"> Appears when the shift lever is in any position except N. 	<ul style="list-style-type: none"> Shift to N. <ul style="list-style-type: none"> ▶ Auto Idle Stop Activates When: P. 399
	<ul style="list-style-type: none"> Appears in white when you turn the ignition switch to START III*1 before fully depressing the clutch pedal. Appears in white when the ambient conditions may cause the windows to fog up or may become different from the climate control settings you have selected while Auto Idle Stop is in operation. 	<ul style="list-style-type: none"> Depress the clutch pedal.
	<ul style="list-style-type: none"> Appears in amber when the following conditions are kept while Auto Idle Stop is in operation: <ul style="list-style-type: none"> - You are not wearing a seat belt. - The shift lever is in any position except N. 	<ul style="list-style-type: none"> Depress the clutch pedal. Wear the seat belt immediately, and continue to keep the shift lever in N next time Auto Idle Stop activates.

*1: Models with the keyless access system have an **ENGINE START/STOP** button instead of an ignition switch.

Message	Condition	Explanation
	<ul style="list-style-type: none"> • Appears when Auto Idle Stop does not activate for some reason. • Appears when the engine restarts automatically. 	<p>➤ Auto Idle Stop Activates When: P. 399</p>
	<ul style="list-style-type: none"> • Appears when Auto Idle Stop does not activate because the engine coolant temperature is low or high. 	<p>➤ Auto Idle Stop does not activate when: P. 399</p>
	<ul style="list-style-type: none"> • Appears when Auto Idle Stop does not activate because the climate control system is in use, and the difference between the set temperature and actual interior temperature becomes significant. 	<p>➤ Auto Idle Stop Activates When: P. 399</p>
 (White)	<ul style="list-style-type: none"> • Appears when Auto Idle Stop does not activate due to the low battery. • Appears when the engine automatically restarts because Auto Idle Stop is in operation, and the battery charge becomes low. 	<p>➤ Auto Idle Stop P. 398</p> <ul style="list-style-type: none"> • Appears even though the battery is fully charged - The system may not read the battery amount correctly after the battery has been charged with the cables connected to the battery. Disconnect the negative ⊖ cable once and reconnect it again to the battery. Drive for a few minutes.

Diesel models

Message	Condition	Explanation
	<p>Models without fuel system primer</p> <ul style="list-style-type: none"> • Appears when you need to regenerate the diesel particulate filter (DPF). This is not a DPF failure. 	<p>➤ Diesel Particulate Filter (DPF) P. 512</p>
	<ul style="list-style-type: none"> • Appears when particulate matter (PM) has started clogging the diesel particulate filter (DPF) system. This is a problem. 	<ul style="list-style-type: none"> • Have your vehicle checked by a dealer.
	<ul style="list-style-type: none"> • Appears when water has accumulated in the fuel system. • Appears if you have parked your vehicle for an extended period. 	<ul style="list-style-type: none"> • Have a dealer drain off the water from the system as soon as possible. Accumulated water may cause damage to the fuel system. <p>Models with fuel system primer</p> <ul style="list-style-type: none"> • Prime the fuel system first. If  does not disappear, have your vehicle checked by a dealer. <p>➤ Priming the Fuel System P. 603</p>
	<p>Models with keyless access system</p> <ul style="list-style-type: none"> • Appears if the engine is cold when you press the ENGINE START/STOP button. 	<ul style="list-style-type: none"> • The engine automatically starts when the symbol disappears. • If the clutch pedal is not depressed, the engine cannot start. <p>➤ Starting the Engine P. 385</p>

Message	Condition	Explanation
	<ul style="list-style-type: none"> • Appears during driving if there is a problem with the engine control system. 	<p>➤ If the PGM-FI Symbol Appears P. 591</p>
	<ul style="list-style-type: none"> • Appears when you cannot restart the engine after the fuel tank has been run dry. Air may have entered the fuel system. 	<p>Models with fuel system primer</p> <p>➤ Priming the Fuel System P. 603</p> <p>Models without fuel system primer</p> <ul style="list-style-type: none"> • Have your vehicle checked by a dealer.
	<ul style="list-style-type: none"> • Appears if you do not use the proper fuel for the climate or regional conditions. 	<ul style="list-style-type: none"> • Use of inadequate fuel may reduce engine power. <p>➤ Fuel recommendation P. 453</p>

Models with forward collision warning

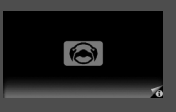

Message	Condition	Explanation
	<ul style="list-style-type: none"> Flashes when the system senses a likely collision with a vehicle in front of you. The beeper sounds. 	<ul style="list-style-type: none"> Take the appropriate means to prevent a collision (apply the brakes, change lanes, etc.) <ul style="list-style-type: none"> ➤ Forward Collision Warning* P. 411

Models with lane departure warning

Message	Condition	Explanation
	<ul style="list-style-type: none"> Appears when your vehicle is too close to the traffic lane lines. The beeper sounds. 	<ul style="list-style-type: none"> Take appropriate action to keep your vehicle within the lane lines. <ul style="list-style-type: none"> ➤ Lane Departure Warning* P. 415

* Not available on all models

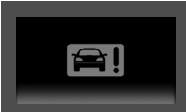
Models with City-Brake Active system

Message	Condition	Explanation
	<ul style="list-style-type: none"> Flashes when the system senses a likely collision with a vehicle in front of you. The beeper sounds. 	<ul style="list-style-type: none"> Depress the brake pedal, and keep an appropriate distance from the vehicle ahead. The alert will disappear. The system automatically applies the brake if a possible collision becomes likely unavoidable. ► City-Brake Active system* P. 434
	<ul style="list-style-type: none"> Changes the display when your vehicle is stopped by the system. The beeper stops. 	

2.0 L engine models

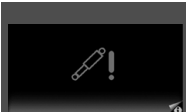
Message	Condition	Explanation
	<ul style="list-style-type: none"> Appears if there is a problem with the adaptive damper system. 	<ul style="list-style-type: none"> Have your vehicle checked by a dealer. With this icon on, your vehicle has limited damping ability without the adaptive damper system.

Gauges

Gauges include the speedometer, tachometer, fuel gauge, and related indicators. They are displayed when the ignition switch is in ON ^{*1}.

Speedometer

Displays your driving speed in km/h or mph*.

Fuel Gauge

Displays the amount of fuel left in the fuel tank.

Tachometer

Shows the number of engine revolutions per minute.

Temperature Gauge

Displays the temperature of the engine coolant.

*1: Models with the keyless access system have an **ENGINE START/STOP** button instead of an ignition switch.

* Not available on all models

Speedometer

Right-hand drive type

Switch between km/h and mph by using the customized features on the i-multi-information display.

 **Customized Features** P. 131

Fuel Gauge

NOTICE

You should refuel when the reading approaches . Running out of fuel can cause the engine to misfire, damaging the catalytic converter.

The actual amount of remaining fuel may differ from the fuel gauge reading.

Temperature Gauge

Driving with the temperature gauge needle in the upper zone can cause serious engine damage. Pull safely to the side of the road and allow engine temperature to return to normal.



 **Overheating** P. 583

i-Multi-Information Display

The i-multi-information display shows the odometer, trip meter, outside temperature indicator, and other gauges. It also displays important messages such as warnings and other helpful information.

Switching the Display

To change the item displayed on the fuel consumption screen:

1. Press and hold the  button until the item blinks.
2. Press the  button to select an item while the item is blinking for about six seconds. The display is fixed when the time elapses and blinking stops.

Switching the Display

Press the  (display/information) button to change the display.

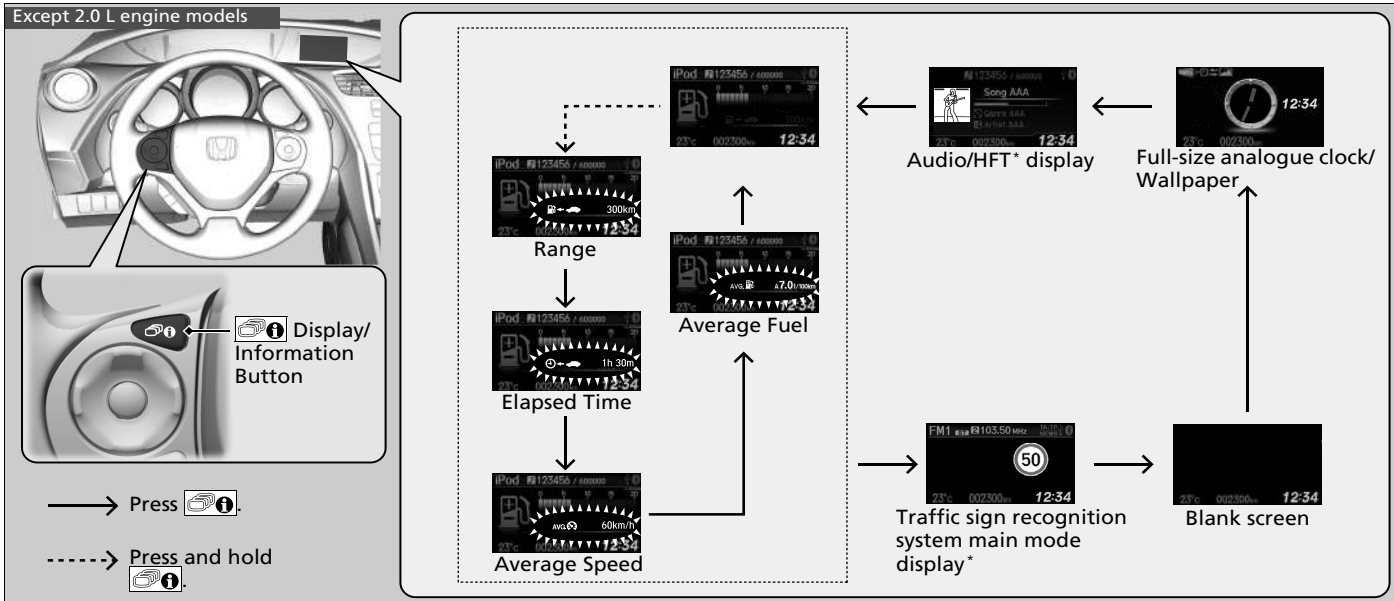

2.0 L engine models

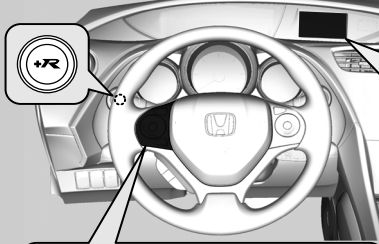

→ Press

-----→ Press and hold

⇒ Press and hold +R.

*1: When the screen is displayed by pressing and holding the button, this message is appeared.

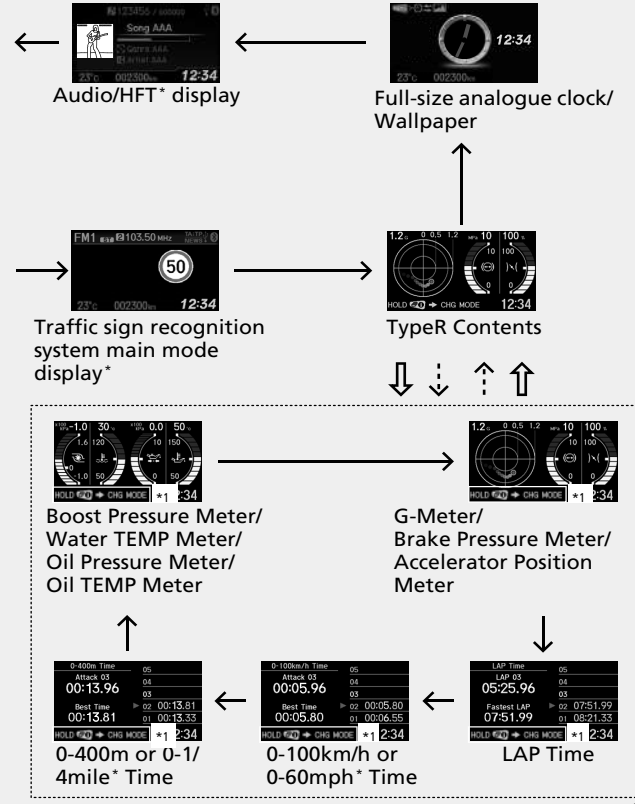
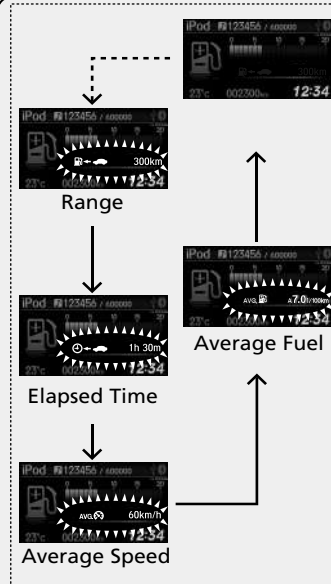

Instrument Panel

* Not available on all models

■ Trip computer

Press the  (Select/Reset) knob to change display.

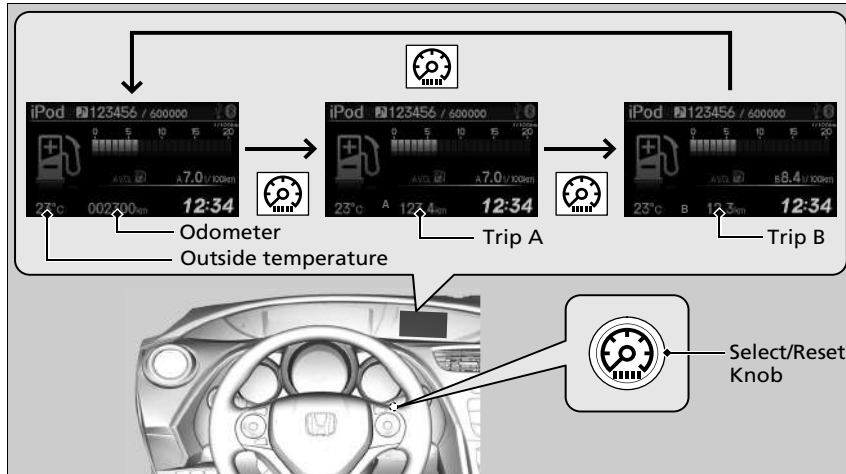

■ Odometer

Shows the total number of kilometres or miles* that your vehicle has accumulated.

■ Trip Meter

Shows the total number of kilometres or miles* driven since the last reset. Meters A and B can be used to measure two separate trips.

■ Resetting a trip meter

To reset a trip meter, display it, then press and hold the  knob. The trip meter is reset to **0.0**.

* Not available on all models

▶▶ Trip Meter

Switch between trip meter A and trip meter B by pressing the  knob, or by using the customized features on the i-multi-information display.

▶ **Customized Features** P. 131

■ Instant Fuel Economy

Shows the instant fuel economy as a bar graph in l/100 km or mpg.

■ Average Fuel Economy

Shows the estimated average fuel economy of each trip meter in l/100 km or mpg. The display is updated at set intervals. When a trip meter is reset, the average fuel economy is also reset.

■ Range

Shows the estimated distance you can travel on the remaining fuel. This distance is estimated from the fuel economy of your previous trips.

■ Elapsed Time

Shows the time elapsed since Trip A or Trip B was reset.

■ Average Speed

Shows the average speed in km/h since Trip A or Trip B was reset.

▶ Instant Fuel Economy

▶ Diesel models

You may temporarily find the instant fuel economy higher than in normal driving while the DPF (diesel particulate filter) system is in operation.

▶ Average Fuel Economy

You can choose whether to reset trip A/B and average fuel economy A/B when you refuel.

- ▶ **Customized Features** P. 131
- ▶ **Switching the Display** P. 120

You can choose an item to be displayed in the fuel consumption screen. Average fuel economy, range, elapsed time, or average speed can be selected.

- ▶ **Customized Features** P. 131
- ▶ **Switching the Display** P. 120

■ Outside Temperature

Shows the outside temperature in Celsius.

If the outside temperature has been below 3°C at the time you turn the ignition switch to ON ^{*1}, the outside temperature indicator blinks for 10 seconds.

■ Adjusting the outside temperature display

Adjust the temperature reading up to $\pm 3^{\circ}\text{C}$ if the temperature reading seems incorrect.

☒ Outside Temperature

The temperature sensor is in the front bumper. Road heat and exhaust from another vehicle can affect the temperature reading when your vehicle speed is less than 30 km/h (19 mph).

It may take several minutes for the display to be updated after the temperature reading has stabilized.

Use the i-multi-information display's customized features to correct the temperature.

☒ **Customized Features** P. 131

*1: Models with the keyless access system have an **ENGINE START/STOP** button instead of an ignition switch.

■ G-Meter*

Displays the strength (G) and direction of the load that is applied to the vehicle during driving.

■ Braking Pressure Meter*

Displays the brake pressure in MPa when the brake is applied.

■ Accelerator Position Meter*

Displays the accelerator position in degrees of %.

■ Boost Pressure Meter*

Displays the turbo boost pressure in kPa.

■ Water TEMP Meter*

Displays the engine coolant temperature in °C.

■ Oil Pressure Meter*

Displays the engine oil pressure in kPa.

■ Oil TEMP Meter*

Displays the engine oil temperature in °C.
Since the actual oil temperature is not measured, the temperature displayed here may differ from the actual temperature.

* Not available on all models

LAP Time*

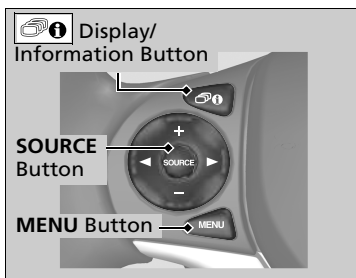



Measures the LAP Time, and displays the previously measured times and the Fastest LAP time.

Measuring LAP Time

1. Operate the  (display/information) button to display the LAP Time measurement screen.
2. Press the **SOURCE** button to start measurement.
3. Press the **SOURCE** button again to stop measurement.
 - ▶ To measure the time per lap, press the **MENU** button at the completion of each lap.

Checking/Clearing history

- A maximum of 99 histories can be stored. Up to five histories are displayed on the screen at the same time. To check the sixth and subsequent histories, operate the  or  button to move the screen while measurement is stopped.
- To clear the history, press and hold the **MENU** button while measurement is stopped.

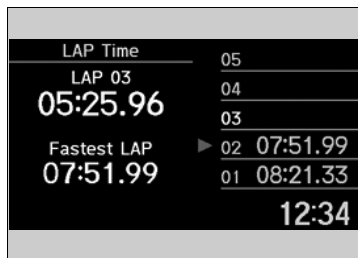

LAP Time*

Be sure to use this measurement function only where and when it is safe to do so.

LAP Time is displayed from 00:00.00 to 99:59.99. When the time exceeds 99:59.99, the display returns to 00:00.00 and measurement continues.

The measured time is stored in the history when the **MENU** button is pressed to confirm that the LAP Time or measurement is finished.

The Fastest LAP in the history is displayed with . While measuring, the numeric value of the current LAP time is highlighted.

When the number of histories exceeds 99, the first history will be overwritten.

While measuring the LAP Time, 0-100 km/h or 0-60 mph*¹ Time and 0-400 m or 0-1/4 mile*¹ Time will not be displayed, even if the  button is pressed.

*1: When you selected the speedometer unit to mph.

* Not available on all models

■ 0-100 km/h or 0-60 mph*1 Time*

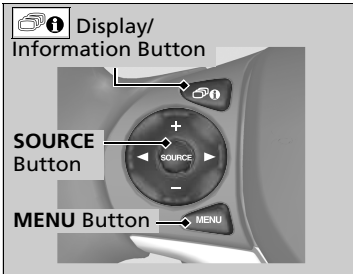

Measures 0-100 km/h or 0-60 mph*1, and displays the previously measured times and the Best Time.

■ Measuring 0-100 km/h or 0-60 mph*1 Time

1. Operate the  (display/information) button to display the 0-100 km/h or 0-60 mph*1 measurement screen.
2. When the **SOURCE** button is pressed, REV Indicators start to count down. Measurement starts after the indicators disappear.
 - ▶ When the vehicle speed is above 2 km/h or 1 mph*1, the REV Indicators are not illuminated even when the **SOURCE** button has been pressed.
3. When the vehicle speed reaches 100 km/h or 60 mph*1, or the **SOURCE** button is pressed, measurement stops.

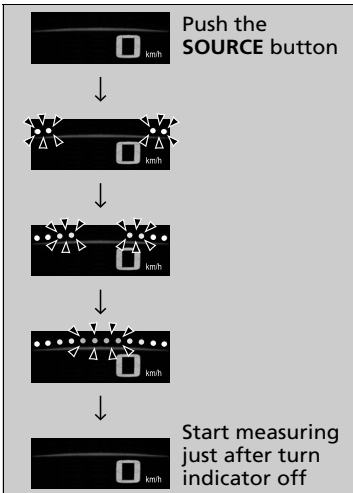

*1: When you selected the speedometer unit to mph.

* Not available on all models

▣ 0-100 km/h or 0-60 mph*1 Time*

Be sure to use this measurement function only where and when it is safe to do so.

0-100 km/h or 0-60 mph*1 Time is displayed from 00:00.00 to 99:59.99.

When the time exceeds 99:59.99, the display returns to 00:00.00 and measurement continues.

The Best Time in the history is displayed with ▶. During measurement, the numeric value of the current Attack is highlighted. The measured time is stored in the history when the finished.

When the number of histories exceeds 99, the first history will be overwritten.

While measuring the 0-100 km/h or 0-60 mph*1 Time, LAP Time and 0-400 m or 0-1/4 mile*1 Time will not be displayed, even if the  button is pressed.

Continued



■ Checking/Clearing history

- A maximum of 99 histories can be stored. Up to five histories are displayed on the screen at the same time. To check the sixth and subsequent histories, operate the \oplus or \ominus button to move the screen while measurement is stopped.
- To clear the history, press and hold the **MENU** button while measurement is stopped.

■ 0-400 m or 0-1/4 mile*1 Time*

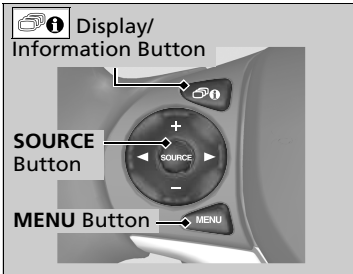

Measures 0-400 m or 0-1/4 mile*1, and displays the previously measured times and the Best Time.

■ Measuring 0-400 m or 0-1/4 mile*1 Time

1. Operate the  (display/information) button to display the 0-400 m or 0-1/4 mile*1 measurement screen.
2. When the **SOURCE** button is pressed, REV Indicators start to count down. Measurement starts after the indicators disappear.
 - ▶ When the vehicle speed is above 2 km/h or 1 mph*1, the REV Indicators are not illuminated even when the **SOURCE** button has been pressed.
3. When the vehicle speed reaches 0-400 m or 0-1/4 mile*1, or the **SOURCE** button is pressed, measurement stops.

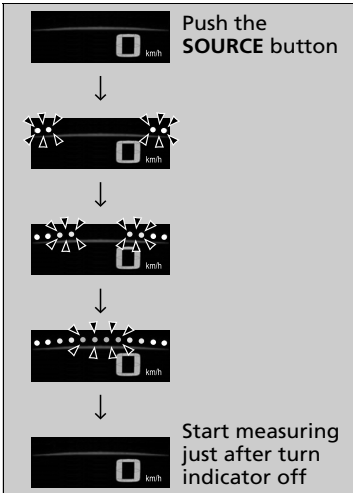

*1: When you selected the speedometer unit to mph.

* Not available on all models

■ 0-400 m or 0-1/4 mile*1 Time*

Be sure to use this measurement function only where and when it is safe to do so.

0-400 m or 0-1/4 mile*1 Time is displayed from 00:00.00 to 99:59.99.

When the time exceeds 99:59.99, the display returns to 00:00.00 and measurement continues.

The Best Time in the history is displayed with . During measurement, the numeric value of the current Attack is highlighted. The measured time is stored in the history when the finished.

When the number of histories exceeds 99, the first history will be overwritten.

While measuring the 0-400 m or 0-1/4 mile*1 Time, LAP Time and 0-100 km/h or 0-60 mph*1 Time will not be displayed, even if the  button is pressed.

Continued



■ Checking/Clearing history

- A maximum of 99 histories can be stored. Up to five histories are displayed on the screen at the same time. To check the sixth and subsequent histories, operate the \oplus or \ominus button to move the screen while measurement is stopped.
- To clear the history, press and hold the **MENU** button while measurement is stopped.

■ Customized Features

Use the i-multi-information display to customize certain features.

■ How to customize

Select the **Vehicle menu** screen by pressing the **MENU** button while the ignition switch is in ON ^{*1}, and the vehicle is at a complete stop. Select **Customise settings**, then press the **SOURCE** button.

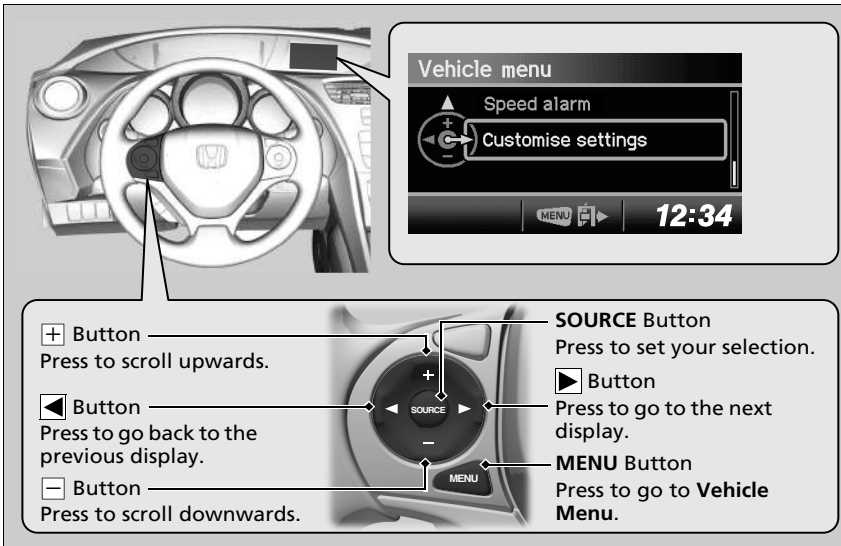



*1: Models with the keyless access system have an **ENGINE START/STOP** button instead of an ignition switch.

* Not available on all models

Continued

▶ Customized Features

To customize other features, press the  /  button.

▶ **List of customizable options** P. 137

▶ **Example of customizing wallpapers*** P. 142

■ Customization flow

Press the **MENU** button.

Vehicle menu

Odometer/trip meter



Trip meter reset



Select trip computer



Range

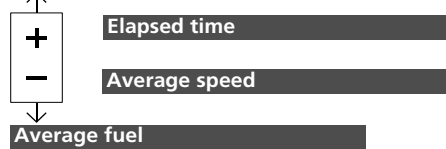

Adjust clock*



Customized Features

You can exit the customizing screen at any time by pressing the **MENU** button.

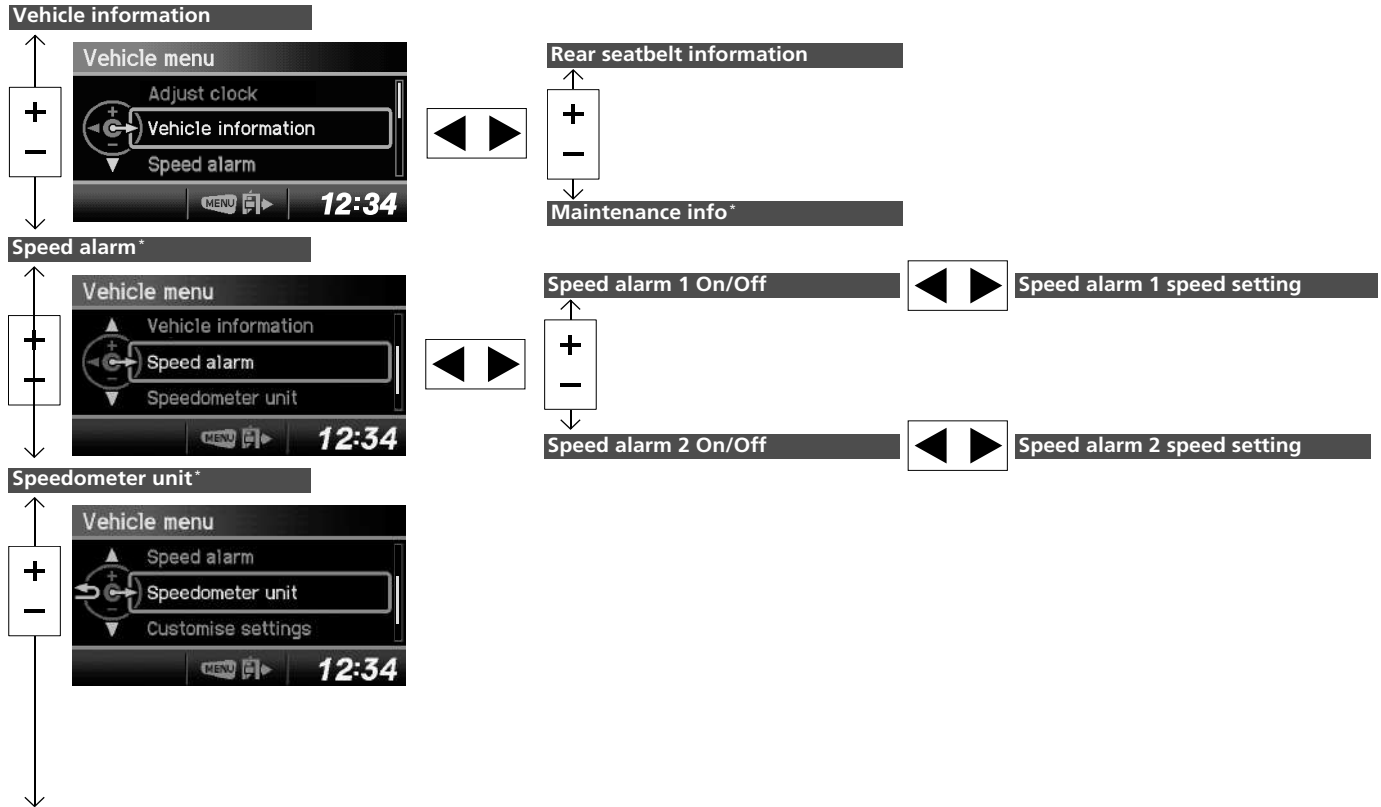

Instrument Panel

* Not available on all models

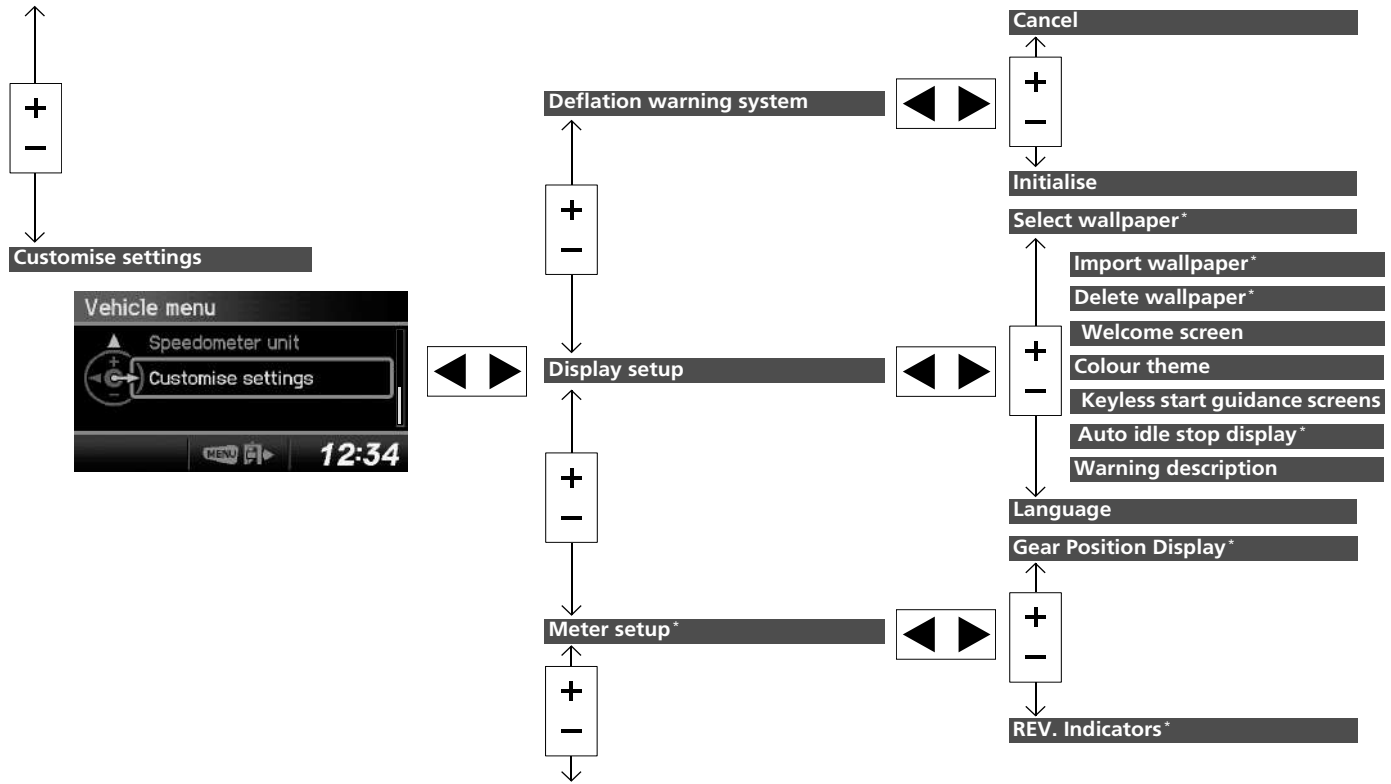

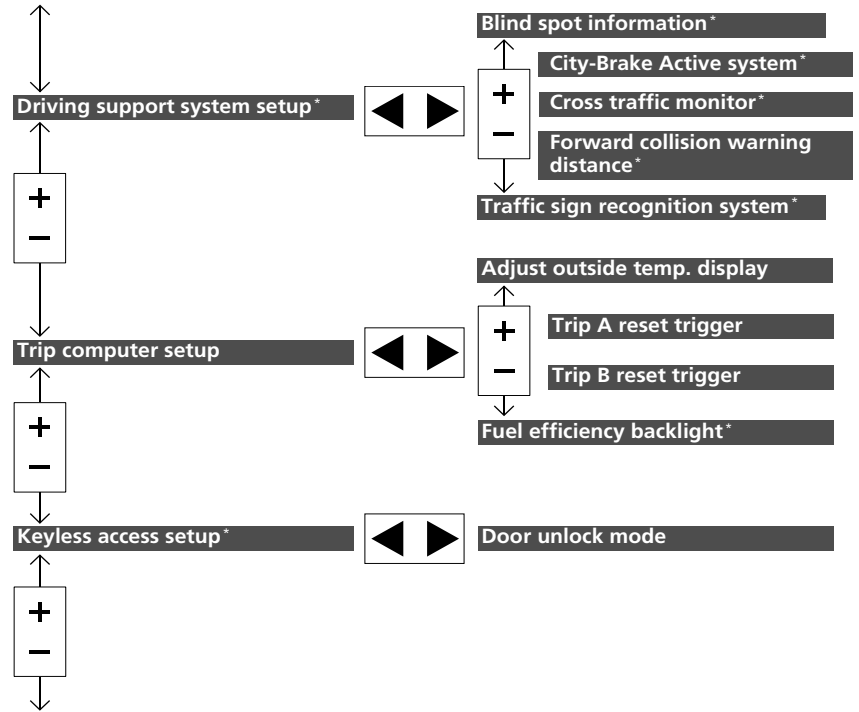

Instrument Panel

* Not available on all models

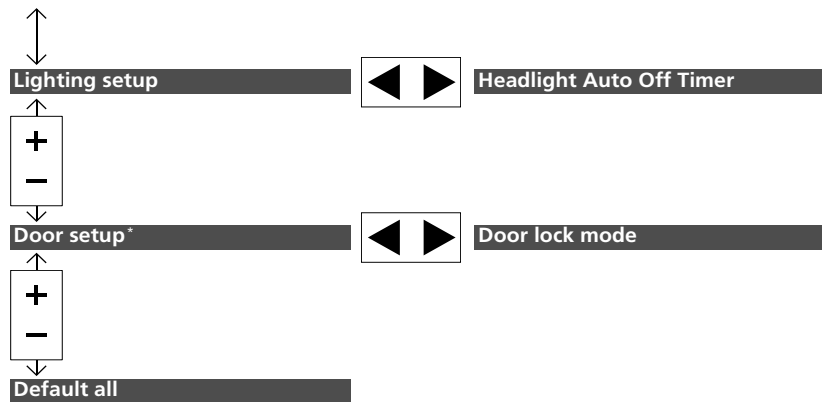



■ List of customizable options

Setup Group	Customizable Features	Description	Selectable settings
Odometer/ trip meter	Trip meter reset	Resets the trip meter.	Trip A/Trip B
	Select trip/odometer	Switches between odometer, trip meter A, and trip meter B.	Odometer*¹/Trip A/Trip B
Select trip computer		Selects an item to be displayed along with instant fuel economy.	Average fuel*¹/Range/ Elapsed time/Average speed
Adjust clock*		Sets time display 12 hour or 24 hour and adjust the time.	12 h*¹/24 h
Vehicle information	Rear seatbelt information	—	—
	Maintenance info*	Resets the service reminder.	No/Yes
Speed alarm*	Speed alarm setting	Sets the speed alarm on and changes the speed alarm setting.	Speed alarm 1 On/Off*¹
			Speed alarm 1 speed setting [50 km/h (30 mph)* ¹]
			Speed alarm 2 On/Off*¹
			Speed alarm 2 speed setting [80 km/h (50 mph)* ¹]
Speedometer unit*		Changes the displayed measurement on the speedometer.	km/h, mph*¹
Customise settings	Deflation warning system	Initialises the deflation warning system.	Cancel/Initialise

*1: Default Setting

* Not available on all models

Setup Group	Customizable Features	Description	Selectable settings	
Customise settings	Display setup	Select wallpaper*	Selects the full-size analogue clock or the wallpaper.	Clock*¹/Image 1/Image 2/Image 3
		Import wallpaper*	Imports an image file for a new wallpaper.	Three images can be stored.  Importing Wallpapers from USB* P. 142
		Delete wallpaper*	Deletes an image file for a wallpaper.	Image 1/Image 2/Image 3
		Welcome screen	Selects whether the welcome screen comes on or not when you turn the ignition switch to ON  ² .	On*¹/Off
		Colour theme	Changes the colour of the screen.	Blue*¹/Red/Amber/Grey
		Keyless start guidance screens	Displays the keyless start guidance when conditions are met to change power mode.	On*¹/Off
		Auto idle stop display*	Selects whether the Auto Idle Stop display comes on or not.	On*¹/Off
		Warning description	Switches warning message to be displayed or not.	On/Off*¹

*1: Default Setting

*2: Models with the keyless access system have an **ENGINE START/STOP** button instead of an ignition switch.

Setup Group	Customizable Features	Description	Selectable settings	
Customise settings	Display setup	Language	Changes the displayed language.	English^{*1}/German/Italian/French/Spanish/Portuguese/Dutch/Danish/Swedish/Norwegian/Finnish/Russian/Polish/Turkish/Czech/Hungarian/Slovakian/Estonian/Latvian/Lithuanian
	Meter setup[*]	Gear Position Display[*]	Turns the Gear Position Display feature on and off.	On^{*1}/Off
		REV. Indicators[*]	Turns the REV. Indicators feature on and off.	On^{*1}/Off
	Driving support system setup[*]	Blind spot information[*]	Changes the setting for the blind spot information.	Audible and visual alert^{*1}/Visual alert/Off
		City-Brake Active system[*]	Turns the City-Brake Active system feature on and off.	On^{*1}/Off
		Cross traffic monitor[*]	Turns the cross traffic monitor feature on and off.	On^{*1}/Off
	Forward collision warning distance[*]	Changes at which distance forward collision warning alerts, or turns the system on and off.	Far/Normal^{*1}/Near/Off	

*1: Default Setting

* Not available on all models

Setup Group	Customizable Features	Description	Selectable settings
Customise settings	Driving support system setup*	Traffic sign recognition system* Selects whether the traffic sign small icons come on.	Small icons on^{*1}/Small icons off
		Adjust outside temp. display Adjusts the temperature reading by a few degrees.	-3°C ~ ±0°C^{*1} ~ +3°C
	Trip computer setup	Trip A reset trigger Sets Trip A and the average fuel economy to reset when you refuel.	With refuel/Manual only^{*1}/IGN Off
		Trip B reset trigger Sets Trip B and the average fuel economy to reset when you refuel.	With refuel/Manual only^{*1}/IGN Off
		Display unit* Changes the displayed measurement on the i-multi-information display.	Auto^{*1}/km/miles
		Fuel efficiency backlight* Turns the ambient meter feature on and off.	On^{*1}/Off
	Keyless access setup*	Door unlock mode Changes which doors unlock when you grab the driver's door handle.	Driver door only^{*1}/All doors
	Lighting setup	Headlight Auto Off Timer Changes the length of time the exterior lights stay on after you close the driver's door.	60sec/30sec/15sec^{*1}/0sec

*1: Default Setting

* Not available on all models

Setup Group	Customizable Features		Description	Selectable settings
Customise settings	Door setup*	Door lock mode	Sets up either the driver's door or all doors to unlock on the first operation of the remote or ignition key.	Driver door only*¹/All doors
	Default all		Cancels/Resets all the customized settings as default.	Cancel Reset all defaults

* 1: Default Setting

* Not available on all models

■ Example of customizing wallpapers*

You can customize the display from clock to wallpaper.

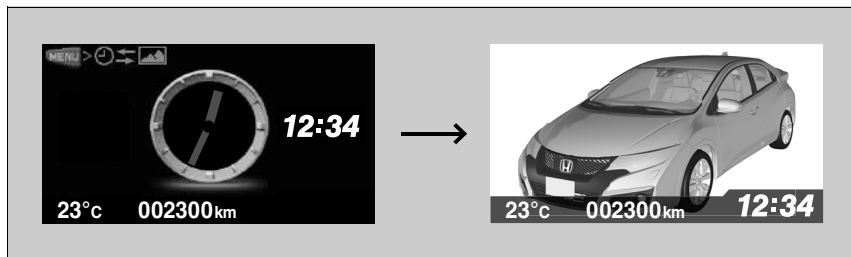

■ Importing Wallpapers from USB*

You can import up to three images, one at a time for wallpaper from a USB flash drive.

Select **Import wallpaper** from **Customise settings** and properly connect a USB flash drive to store an image.



1. Connect the USB flash drive to the USB port.
➤ **USB Port(s)** P. 223
2. Press the **MENU** button.
3. Select **Customise settings** with the **[+]** / **[-]** button, then press the **SOURCE** button.
4. Select **Display setup** with the **[+]** / **[-]** button, then press the **SOURCE** button.

☒ Customized Features

- When importing wallpaper files, the image must be in the USB flash drive's root directory. Images in a folder cannot be imported.
- The file format of the image that can be imported is BMP (bmp) or JPEG (jpg).
- Each image file can be up to 2 MB.
- The image size between 1,920 x 936 (display's maximum image size) and 480 x 234 pixels can be displayed in full screen.
- Up to 255 files can be selected.
- Up to 64 characters can be displayed in the file name.



5. Select **Import wallpaper** with the $\left[\begin{smallmatrix} + \\ - \end{smallmatrix} \right]$ / $\left[\begin{smallmatrix} \leftarrow \\ \rightarrow \end{smallmatrix} \right]$ button, then press the **SOURCE** button.
 - ▶ The file names are displayed on the screen.



6. Press the $\left[\begin{smallmatrix} \leftarrow \\ \rightarrow \end{smallmatrix} \right]$ button until the file name you want to store appears on the centre of the display, then press the **SOURCE** button.

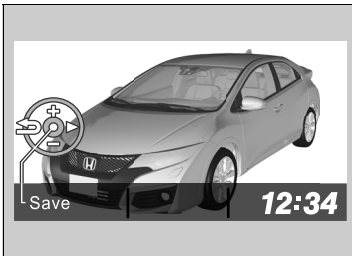

7. The preview of the imported data is displayed. Press the **SOURCE** button if it is OK.
8. Press the **SOURCE** button to save the image file.



9. Select the location you want to store the image file in with the \oplus / \ominus button, then press the **SOURCE** button.
10. Press the **MENU** button to exit the customize screen.

■ Selecting a Wallpaper*

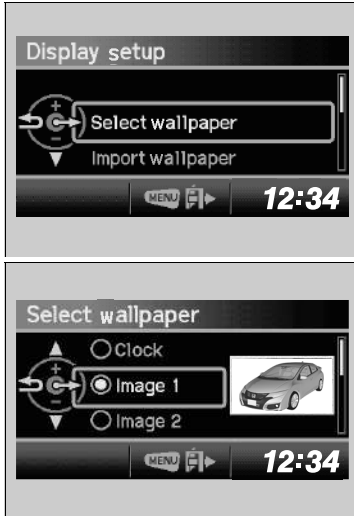

1. Press the **MENU** button.
2. Select **Customise settings** with the $\boxed{+}$ / $\boxed{-}$ button, then press the **SOURCE** button.
3. Select **Display setup** with the $\boxed{+}$ / $\boxed{-}$ button, then press the **SOURCE** button.
4. Select **Select wallpaper** with the $\boxed{+}$ / $\boxed{-}$ button, then press the **SOURCE** button.
5. Select the image file you want with the $\boxed{+}$ / $\boxed{-}$ button, then press the **SOURCE** button.
 - ▶ When the scroll is stopped, the thumbnail is displayed.
6. Press the **MENU** button to exit the customize screen.

* Not available on all models

Controls

This chapter explains how to operate the various controls necessary for driving.

Clock	148
Locking and Unlocking the Doors	
Key Types and Functions	149
Locking/Unlocking the Doors from the Outside.....	152
Locking/Unlocking the Doors from the Inside	157
Childproof Door Locks	158
Opening and Closing the Tailgate	159
Security System	
Immobilizer System	162
Security System Alarm *	162
Ultrasonic Sensors *	164
Super Locking *	165
Opening and Closing the Windows	166
Opening and Closing the Sunshade *	169

Operating the Switches Around the Steering Wheel	
Ignition Switch *	170
ENGINE START/STOP Button *	171
Ignition Switch and Power Mode Comparison	173
Turn Signals	174
Light Switches	174
Fog Lights	177
Headlight Adjuster*	179
High Beam Support System *	180
Daytime Running Lights	182
Wipers and Washers	183
Brightness Control	187
Rear Demister/Heated Door Mirror* Button	188
Adjusting the Steering Wheel	189

Adjusting the Mirrors	
Interior Rearview Mirror.....	190
Power Door Mirrors *	191
Adjusting the Seats	
Adjusting the Seat Positions.....	193
Interior Lights/Interior Convenience Items	
Interior Lights	202
Interior Convenience Items	204
Climate Control System*	
Models with synchronized mode	
Using Automatic Climate Control	215
Models without synchronized mode	
Using Automatic Climate Control	218
Automatic Climate Control Sensors	220











* Not available on all models

Adjusting the Clock





You can adjust the time in the clock display with the ignition switch in ON *1.



Models with one display

1. Press the **MENU** button.
2. Select **Adjust clock** with the  /  button, then press the **SOURCE** button.
3. Press the  /  button to change the setting between **12 h** and **24 h**.
4. Select hour or minute with the  /  button.
5. Press the  /  button to adjust the numbers up or down.
6. Select  with the  /  button, then press the **SOURCE** button to enter your selection.

Models with two displays

1. Press the  button.
2. Select **Settings**.
3. Select **Info**.
4. Select the **Clock** tab.
5. Select **Clock Adjustment**.
6. Select  or  to change hour.
7. Select  or  to change minute, then select **OK**.

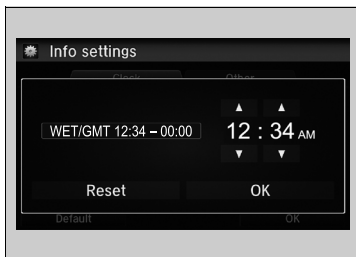

Adjusting the Clock

You cannot adjust the time while the vehicle is moving.

Models with navigation system

The clock is automatically updated through the navigation system, so the time does not need to be adjusted.

Models with two displays

You can customize the clock display to show the 12 hour clock or 24 hour clock.

 **Customized Features** P. 313

The clock display is set to off by factory default. You can turn the clock display on and off.

 **Customized Features** P. 313

The clock is automatically updated when your smartphone is connected to the audio system.

*1: Models with the keyless access system have an **ENGINE START/STOP** button instead of an ignition switch.

Key Types and Functions

This vehicle comes with the following keys:

Keys

Retractable Key*



Keyless Remote*



Use the key to start and stop the engine, and to lock and unlock the doors and tailgate.

Key Types and Functions

All the keys have an immobilizer system. The immobilizer system helps to protect against vehicle theft.

Immobilizer System P. 162

The keys contain precision electronics. Adhere to the following advice to prevent damage to the electronics:

- Do not leave the keys in direct sunlight, or in locations with high temperature or high humidity.
- Do not drop the keys or set heavy objects on them.
- Keep the keys away from liquids.
- Do not take the keys apart except for replacing the battery.

If the circuits in the keys are damaged, the engine may not start, and the remote transmitter may not work.

If the keys do not work properly, have them inspected by a dealer.

* Not available on all models

Continued

■ **Keyless remote***

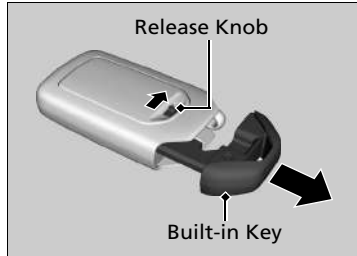

The built-in key can be used to lock/unlock the doors and tailgate when the keyless remote battery becomes weak and the power door lock/unlock operation is disabled. To remove the built-in key, pull it out while sliding the release knob. To reinstall the built-in key, push the built-in key into the keyless remote until it clicks.

■ **Retractable keys***

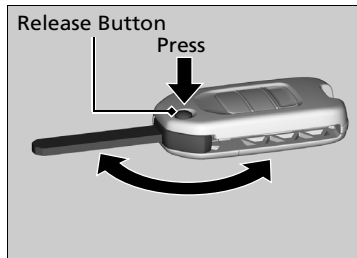

The key folds up inside the remote transmitter.

1. Press the release button to release the key out from the transmitter.
 - ▶ Make sure to fully extend the key.
2. To close the key, press the release button then push the key inside the transmitter until you hear a click.

▶▶ Retractable keys*

If the key is not fully extended, the immobilizer system may not work properly, and the engine may not start. Avoid contact with the key whenever it extends or retracts.

■ Key Number Tag

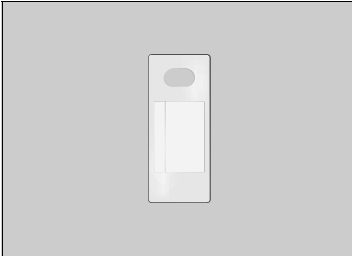

Contains a number that you will need if you purchase a replacement key.

▣ Key Number Tag

Keep the key number tag separate from the key in a safe place outside of your vehicle.

If you wish to purchase an additional key, contact a dealer.

If you lose your key and you cannot start the engine, contact a dealer.

Locking/Unlocking the Doors from the Outside

■ Using the Keyless Access System*

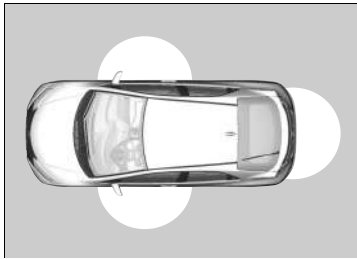

When you carry the keyless remote, you can lock/unlock the doors and open the tailgate.

You can lock/unlock the doors within a radius of about 80 cm (32 inches) of the outside door handle.

You can open the tailgate within about 80 cm (32 inches) radius from the tailgate release button.

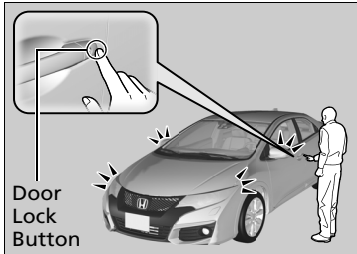

■ Locking the doors and tailgate

Press the door lock button on the front door or the tailgate.

- ▶ Some exterior lights flash three times; all the doors and tailgate lock and the security system sets.

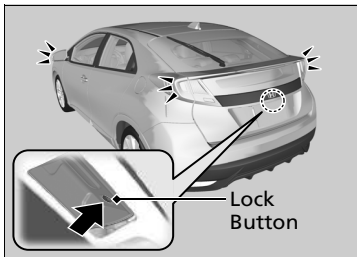

▶▶ Locking/Unlocking the Doors from the Outside

Models with keyless access system

Right-hand drive type

You cannot lock any doors from the outside when the keyless remote is inside the vehicle, and the beeper sounds. If you want to lock a door while the remote is still in the vehicle, do any of the following four times:

- Press the lock button on the keyless remote.
- Turn the key in the cylinder to lock.
- Press the door lock button on the door handle or the tailgate.

Models with keyless access system

You can lock or unlock doors using the remote transmitter or keyless access system only when the power mode is in VEHICLE OFF.

▶▶ Using the Keyless Access System*

- Do not leave the keyless remote in the vehicle when you get out. Carry it with you.
- Even if you are not carrying the keyless remote, you can lock/unlock the doors while someone else with the remote is within range.
- If you grip a front door handle wearing gloves, the door sensor may be slow to respond or may not respond by unlocking the doors.
- The door may be unlocked if the door handle is covered with water in heavy rain or in a carwash if the keyless remote is within range.
- You cannot unlock the door by gripping the handle after two seconds of locking it.
- The door may not open if you pull it immediately after gripping the door handle. Grip the handle again and confirm that the door is unlocked before pulling the handle.

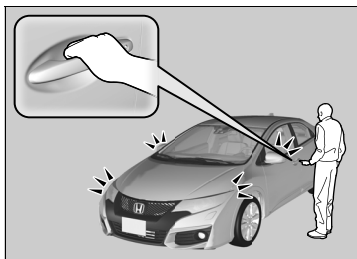

■ Unlocking the doors and tailgate

Grab the driver's door handle:

- ▶ The driver's door unlocks.
- ▶ Some exterior lights flash once.

Grab the front passenger's door handle:

- ▶ All the doors and tailgate unlock.
- ▶ Some exterior lights flash once.

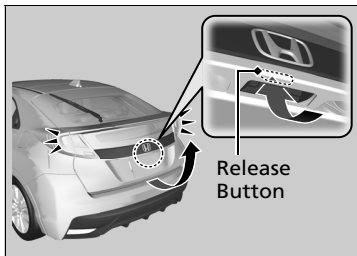

Press the tailgate release button:

- ▶ The tailgate unlocks.
- ▶ Some exterior lights flash once.

▶ Using the Keyless Access System*

- Even within the 80 cm (32 inches) radius, you may not be able to lock/unlock the doors with the keyless remote if it is above or below the outside handle.
- The keyless remote may not operate if it is too close to the door and door glass.

If you do not open a door within 30 seconds of unlocking the vehicle, the doors will automatically relock.

You can customize the door unlock mode setting.

▶ **Customized Features** P. 131

* Not available on all models

Continued

■ Using the Remote Transmitter

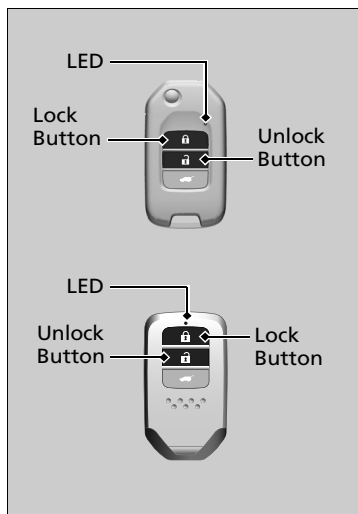

■ Locking the doors

Press the lock button.

- ▶ Some exterior lights flash three times, all the doors and tailgate lock, and the security system sets.

■ Unlocking the doors

Press the unlock button.

Once:

- ▶ Some exterior lights flash once, and the driver's door unlocks.

Twice:

- ▶ The remaining doors and the tailgate unlock.

▣ Using the Remote Transmitter

If you do not open a door within 30 seconds of unlocking the vehicle with the remote transmitter, the doors will automatically relock.

If the interior light switch is in the door activated position, the interior lights come on when you press the unlock button.

No doors opened: The lights fade out after 30 seconds.

Doors relocked with the remote: The lights go off immediately.

▣ **Interior Lights** P. 202

The remote transmitter uses low-power signals, so the operating range may vary depending on the surroundings.

▣ **Models without keyless access system**

The remote transmitter will not work when the key is in the ignition switch.

The remote will not lock the vehicle when a door is open.

If the distance at which the remote transmitter works varies, the battery is probably low.

If the LED does not come on when you press a button, the battery is dead.

▣ **Replacing the Button Battery** P. 544

You can customize the door unlock mode setting.

▣ **Customized Features** P. 131

■ Locking/Unlocking the Doors Using a Key

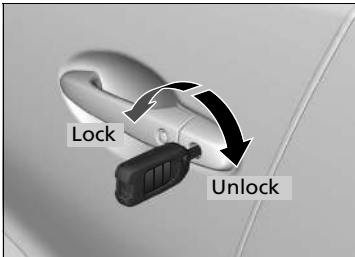

Fully insert the key and turn it.

■ Locking a Door Without Using a Key

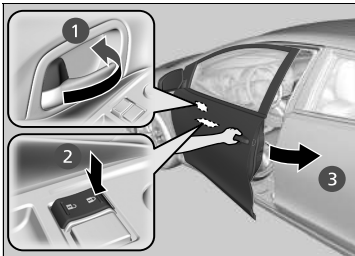

■ Locking the driver's door

Push the lock tab forward ① or push the master door lock switch in the lock direction ②, then pull and hold the outside door handle ③. Close the door, then release the handle.

■ Locking the passenger's doors

Push the lock tab forward and close the door.

■ Lockout prevention system

The doors and tailgate cannot be locked when the key is in the ignition switch*1, or the keyless remote is inside the vehicle, and any door or the tailgate is open.

*1: Models with the keyless access system have an **ENGINE START/STOP** button instead of an ignition switch.

▶ Locking/Unlocking the Doors Using a Key

When you lock the driver's door with the key, all the other doors and tailgate lock at the same time.

▶ Models without security system

To unlock the driver's door, turn the key and release it.

▶ Models with security system

Unlocking the doors with the key causes the security system to alarm. Always unlock the doors and tailgate with the remote transmitter.

▶ Locking a Door Without Using a Key

When you lock the driver's door, all the other doors and tailgate lock at the same time. Make sure you have the key in your hand before locking the door to prevent it from being locked in the vehicle.

Low Keyless Remote Signal Strength*

The vehicle transmits radio waves to locate the keyless remote when locking/unlocking the doors, opening the tailgate, or to start the engine.

In the following cases, locking/unlocking the doors or opening the tailgate or starting the engine may be inhibited or operation may be unstable:

- Strong radio waves are being transmitted by nearby equipment.
- You are carrying the keyless remote together with telecommunications equipment, notebook computers, mobile phones, or wireless machines.
- A metallic object is touching or covering the keyless remote.

Low Keyless Remote Signal Strength*

Communication between the keyless remote and the vehicle consumes the keyless remote battery. The keyless remote battery lasts about two years. This changes by how often you use the remote. The battery is consumed whenever the keyless remote is receiving strong radio waves. Avoid placing it near electrical appliances such as televisions and personal computers.

Locking/Unlocking the Doors from the Inside

■ Using the Lock Tab

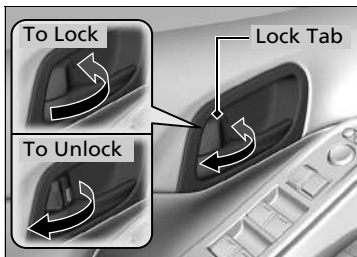

■ Locking a door

Push the lock tab forward.

■ Unlocking a door

Pull the lock tab rearward.

■ Unlocking Using the Front Door Inner Handle

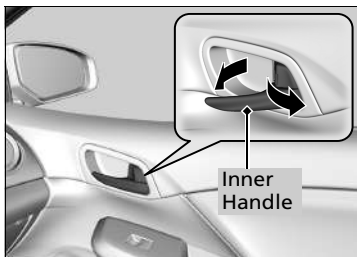

Pull the front door inner handle.

- ▶ The door unlocks and opens in one motion.

☒ Using the Lock Tab

When you lock the door using the lock tab on the driver's door, all the other doors and tailgate lock at the same time.

When you unlock the door using the lock tab on the driver's door, only the driver's door will unlock.

☒ Unlocking Using the Front Door Inner Handle

The front door inner handles are designed to allow front seat occupants to open the door in one motion. However, this feature requires that front seat occupants never pull a front door inner handle while the vehicle is in motion.

Children should always ride in a rear seat where childproof door locks are provided.

☒ **Childproof Door Locks** P. 158

■ Using the Master Door Lock Switch

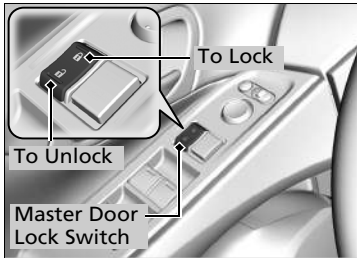

Press the master door lock switch in as shown to lock or unlock all doors and the tailgate.

Childproof Door Locks

The childproof door locks prevent the rear doors from being opened from the inside regardless of the position of the lock tab.

■ Setting the Childproof Door Locks

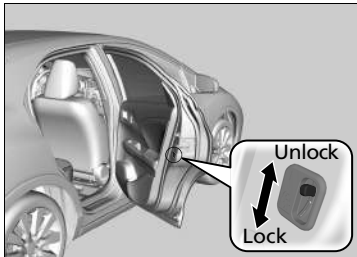

Slide the lever in the rear door to the lock position, and close the door.

■ When opening the door

Open the door using the outside door handle.

▣ Using the Master Door Lock Switch

When you lock/unlock the driver's door using the master lock switch, all the other doors and tailgate lock/unlock at the same time.

▣ Childproof Door Locks

To open the door from the inside when the childproof door lock is on, put the lock tab in the unlock position, lower the rear window, put your hand out of the window, and pull the outside door handle.

Precautions for Opening/Closing the Tailgate

Always make sure individuals and objects are clear of the tailgate before opening or closing it.

■ Opening the tailgate

- Open the tailgate all the way.
 - ▶ If it is not fully opened, the tailgate may begin to close under its own weight.
- Be careful when it is windy. The wind may cause the tailgate to close.

■ Closing the tailgate

Keep the tailgate closed while driving to:

- ▶ Avoid possible damage.
- ▶ Prevent exhaust gas from leaking into the vehicle.
- ▶ **Carbon Monoxide Gas** P. 79

⚠ Precautions for Opening/Closing the Tailgate

Be careful not to hit your head on the tailgate or to put your hands between the tailgate and the luggage area when closing the tailgate.

When you are storing or picking up luggage from the luggage area while the engine is idling, do not stand in front of the exhaust pipe. You may get burned.

Do not allow any passenger in the luggage space. They may get hurt during hard braking, a sudden acceleration, or a crash.

Using the Tailgate Release Button

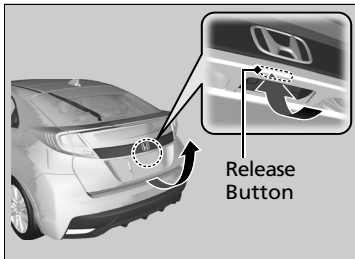

When all the doors are unlocked or the tailgate unlock button on the remote transmitter is pressed, the tailgate is unlocked. Press the tailgate release button and lift open the tailgate.

Models with keyless access system

With the tailgate locked, you can still open the tailgate while carrying the keyless remote with you.

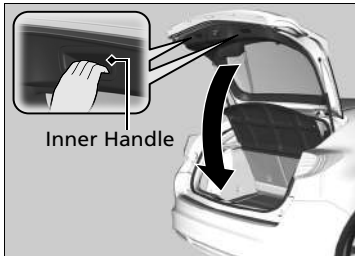

To close the tailgate, grab the inner handle, pull the tailgate down, and push it closed from outside.

If you close the tailgate when all the doors are locked, the tailgate locks automatically.

- Some exterior lights flash three times.

Using the Tailgate Release Button

Do not leave the key, remote transmitter, or keyless remote in the luggage area before closing the tailgate.

Models with keyless access system

Even if you are not carrying the keyless remote, you can unlock the tailgate while someone else with the remote is within range.

Remote Transmitter

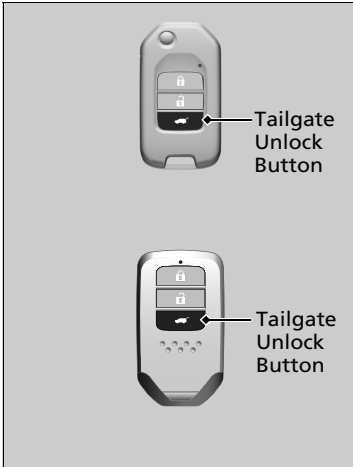

Press the tailgate unlock button to unlock the tailgate.

Remote Transmitter

If you have unlocked and opened the tailgate using the remote transmitter, or keyless remote, when closing, the tailgate locks automatically.

Immobilizer System

The immobilizer system prevents a key that has not been pre-registered from starting the engine. Each key contains electronic transmitters that use electronic signals to verify the key.

Pay attention to the following when inserting the key into the ignition switch or selecting the ACCESSORY mode with the **ENGINE START/STOP** button*:

- Do not allow objects that emit strong radio waves near the ignition switch.
- Make sure the key is not covered by or touching a metal object.
- Do not bring a key from another vehicle's immobilizer system near the ignition switch or with the keyless remote.

Security System Alarm *

The security system alarm activates when the tailgate, bonnet, or doors are opened without the remote transmitter or keyless remote.

■ When the security system alarm activates

The horn sounds intermittently, and the turn signal lights flash.

■ To deactivate the security system alarm

Unlock the vehicle using the remote transmitter or keyless remote, or the ignition switch is turned ON *1. The system, along with the horn and flashing lights, is deactivated.

*1: Models with the keyless access system have an **ENGINE START/STOP** button instead of an ignition switch.

* Not available on all models

Immobilizer System

NOTICE

Leaving the ignition key in the vehicle can result in theft or accidental movement of the vehicle. Always take the ignition key with you whenever you leave the vehicle unattended.

If the system repeatedly does not recognize the coding of your key, contact your dealer. If you have lost your key and cannot start your engine, contact a dealer.

Do not alter the system or add other devices to it. Doing so may damage the system and make your vehicle inoperable.

Security System Alarm *

The security alarm continues for 30 seconds, then the system resets. If the cause of the alarm continues, alarming will repeat several times at about five second intervals.

■ Setting the security system alarm

The security system alarm automatically sets when the following conditions have been met:

- The ignition switch is in LOCK **[0]***1, and the key has been removed from the ignition switch.
- The bonnet is closed.
- All doors and the tailgate are locked with the key, remote transmitter, or keyless access system.

■ When the security system alarm sets

The security system alarm indicator in the instrument panel blinks. When the blinking interval changes after about 15 seconds, the security system is set.

■ To cancel the security system alarm

The security system is cancelled when the vehicle is unlocked using the remote transmitter or keyless access system, or the ignition switch is turned to ON **[II]***1. The security system alarm indicator goes off at the same time.

Unlock the vehicle using the remote transmitter or keyless remote, or the ignition switch is turned ON **[II]***1. The system, along with the horn and flashing lights, is deactivated.

*1: Models with the keyless access system have an **ENGINE START/STOP** button instead of an ignition switch.

* Not available on all models

▣ Security System Alarm*

Do not set the security system alarm when someone is in the vehicle or a window is open. The system can accidentally activate when unlocking the door with the lock tab.

If the battery goes dead after you have set the security system alarm, the security alarm may go off once the battery is recharged or replaced. If this occurs, deactivate the security system alarm by unlocking a door using the remote transmitter or keyless access system.

Do not attempt to alter this system or add another device to it.

Do not unlock the door using the key. The security system alarm goes off.



Ultrasonic Sensors*

The ultrasonic sensors activate only when the security system alarm sets. The sensors detect if someone intrudes into the passenger compartment through a window or moves in the compartment, and activate the alarm.

■ To set the security system alarm without activating the ultrasonic sensors

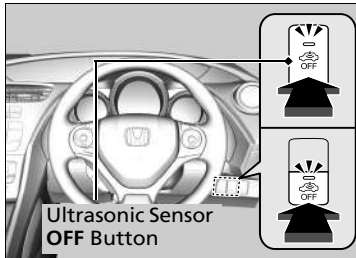
You can set the security system alarm without activating the ultrasonic sensor.



To turn off the ultrasonic sensor system, press the ultrasonic sensor **OFF** button after you remove the key from the ignition switch, or with the key in the ACCESSORY  or LOCK *1.

▶▶ Ultrasonic Sensors*

Do not set the security system alarm while someone is in the vehicle, or if a window is open. The system may accidentally activate when the ultrasonic sensor detects vibrations or loud sounds.

Do not unlock the door using the key. The security system alarm goes off.

*1: Models with the keyless access system have an **ENGINE START/STOP** button instead of an ignition switch.

* Not available on all models

Super Locking*

The super locking function disables the lock tabs on all doors.

■ To activate the super locking function

- Turn the key in the driver's door towards the vehicle front twice within five seconds.
- Press the lock button on the remote transmitter twice within five seconds.

Models with keyless access system

- Press the door lock button on the door handle or the tailgate twice within five seconds.

■ To cancel the super locking function

Unlock the driver's door with the remote transmitter or keyless access system.

Super Locking*

⚠ WARNING

No one must be inside the vehicle with the super locking set. Persons locked in can get seriously sick or die from the heat built inside the vehicle if left in the sun.

Make sure there is no one inside the vehicle before setting the super locking function.

Models with security system

Do not unlock the door using the key. The security system alarm goes off.

* Not available on all models

Opening and Closing the Windows

Opening/Closing the Power Windows

The power windows can be opened and closed when the ignition switch is in ON **II***1, using the switches on the doors. The driver's side switches can be used to open and close all the windows.

The power window lock button on the driver's side must be switched off (not pushed in, indicator off) to open and close the windows from anywhere other than the driver's seat.

When the power window lock button is pushed in, you can only operate the driver's window. Turn the power window lock button on if a child is in the vehicle.

Opening/Closing Windows with Auto-Open/Close Function

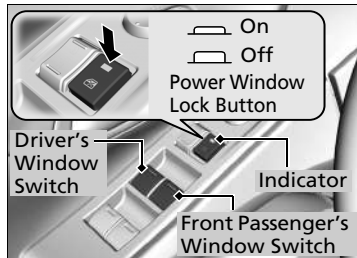

Automatic operation

To open: Push the switch down firmly.

To close: Pull the switch up firmly.

The window opens or closes completely. To stop the window at any time, push or pull the switch briefly.

Manual operation

To open: Push the switch down lightly, and hold it until the desired position is reached.

To close: Pull the switch up lightly, and hold it until the desired position is reached.

Opening/Closing the Power Windows

WARNING

Closing a power window on someone's hands or fingers can cause serious injury.

Make sure your passengers are away from the windows before closing them.

WARNING: Always take the ignition key with you whenever you leave the vehicle alone (with other occupants).

The power windows can be operated for up to 10 minutes after you turn the ignition switch off*1.

Auto-open/close function on front windows

Opening either front door cancels this function.

Auto-open/close function on all windows

Closing the driver's door cancels this function.

Auto Reverse

If a power window senses resistance when closing automatically, it stops closing and reverse direction.

The driver's window auto reverse function is disabled when you continuously pull up the switch.

The auto reverse function stops sensing when the window is almost closed to ensure that it fully closes.

*1: Models with the keyless access system have an **ENGINE START/STOP** button instead of an ignition switch.

■ Opening/Closing Windows without Auto-Open/Close Function

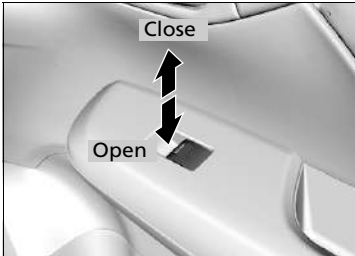

To open: Push the switch down.
To close: Pull the switch up.

Release the switch when the window reaches the desired position.

■ Opening/Closing Windows with the Remote *

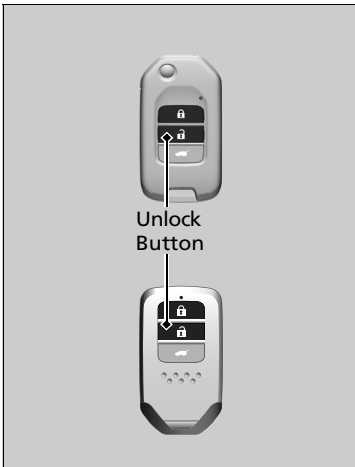

To open: Press the unlock button twice within 10 seconds and hold it down for the second time.
To close: Press the lock button twice within 10 seconds and hold it down for the second time.

If the windows stop midway, repeat the procedure.

* Not available on all models

Continued

■ Closing the Windows with the Key*

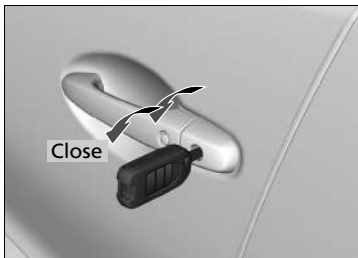

To close: Lock the driver's door with the key. Within 10 seconds of returning the key to the central position, turn the key in the lock direction and hold it there.

Release the key to stop the windows at the desired position. If you want further adjustment, repeat the same operation.

☒ Closing the Windows with the Key*

Do not unlock the door using the key. The security system alarm goes off.

Opening/Closing the Sunshade

You can operate the sunshade only when the ignition switch is in ON *¹. Use the switch in the front of the ceiling to open and close the sunshade.

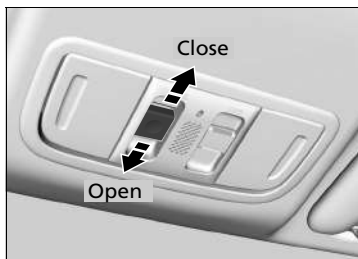

Automatic operation

To open: Push the switch forward firmly.

To close: Pull the switch back firmly.

The sunshade automatically opens or closes all the way. To stop the sunshade midway, touch the switch briefly.

Manual operation

To open: Push the switch forward lightly, and hold it until the desired position is reached.

To close: Pull the switch back lightly, and hold it until the desired position is reached.

*1: Models with the keyless access system have an **ENGINE START/STOP** button instead of an ignition switch.

* Not available on all models

Opening/Closing the Sunshade

⚠ WARNING

Opening or closing the sunshade on someone's hands or fingers can cause serious injury.

Make sure all hands and fingers are clear of the sunshade before opening or closing it.

WARNING: Always take the ignition key with you whenever you leave the vehicle alone (with other occupants).

The power sunshade can be operated for up to 10 minutes after you turn the ignition switch to off*¹.

Auto-open/close function on front windows

Opening either front door cancels this function.

Auto-open/close function on all windows

Closing the driver's door cancels this function.

When resistance is detected, the auto reverse function causes the sunshade to change directions, then stop. Auto reverse stops sensing when the sunshade is almost closed to ensure that it fully closes.

Ignition Switch *

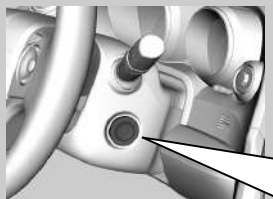

- 0** LOCK: Insert and remove the key in this position.
- I** ACCESSORY: Operate the audio system and other accessories in this position.
- II** ON: This is the position when driving.
- III** START: This position is for starting the engine. The switch returns to ON **II** when you let go of the key.

Ignition Switch *

Manual transmission models

WARNING

Removing the key from the ignition switch while driving locks the steering. This can cause you to lose control of the vehicle.

Remove the key from the ignition switch only when parked.

Automatic transmission models

You cannot take the key out unless the shift lever is in **P**.

All models

If you open the driver's door when the key is in LOCK **0** or ACCESSORY **I**, the following messages appear on the i-multi-information display:

- In LOCK **0**: 
- In ACCESSORY **I**: 

If the key won't turn from LOCK **0** to ACCESSORY **I**, turn the key while moving the steering wheel left and right. The steering wheel will unlock, allowing the key to turn.

ENGINE START/STOP Button*

Changing the Power Mode

Automatic Transmission

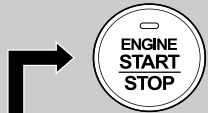

VEHICLE OFF (LOCK)

Indicator in the button is off. The steering wheel is locked. The power to all electrical components is turned off.



ACCESSORY

Indicator in the button is on. Indicator in the button blinks (from ON to ACCESSORY). Operate the audio system and other accessories in this position.



ON

Indicator in the button is on. All electrical components can be used.

Without pressing the brake pedal

➡ Press the button without the shift lever in **P**.

➡➡ Shift to **P**, then press the button.

Manual Transmission

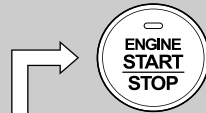

VEHICLE OFF (LOCK)

Indicator in the button is off. The steering wheel is locked. The power to all electrical components is turned off.



ACCESSORY

Indicator in the button is on. Indicator in the button blinks (from ON to ACCESSORY). Operate the audio system and other accessories in this position.



ON

Indicator in the button is on. All electrical components can be used.

Without pressing the clutch pedal

➡➡ Press the button.

ENGINE START/STOP Button*

ENGINE START/STOP Button Operating Range

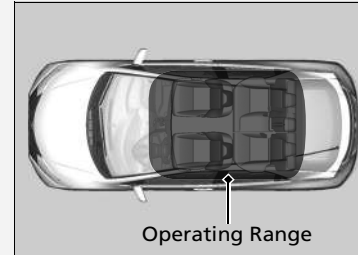

You can start the engine when the keyless remote is inside the vehicle. The engine may also run if the keyless remote is close to a door or window, even if it is outside the vehicle.

ON mode:

Indicator in the button is off, if the engine is running.

If the keyless remote battery is weak, the beeper sounds and appears on the i-multi-information display.

▶ **If the Keyless Remote Battery is Weak**

P. 576

■ Power Mode Reminder

If you open the driver's door when the power mode is set to ACCESSORY, a warning buzzer sounds.

■ Keyless Remote Reminder

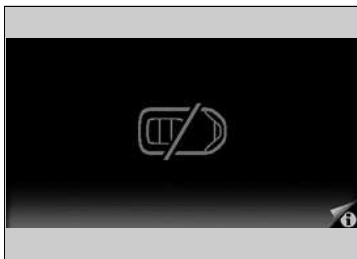

Warning buzzers may sound from inside or/ and outside the vehicle to remind you that the keyless remote is out of the vehicle. If the buzzer continues even after the remote is put back inside, place it to be within its operational range.

■ When the power mode is in ON

If the keyless remote is taken out of the vehicle, and the driver's door is closed, warning buzzers sound from both inside and outside the vehicle. A warning message on the i-multi-information display notifies the driver inside that the remote is out.

■ When the power mode is in ACCESSORY or in VEHICLE OFF (LOCK)

If the keyless remote is taken out of the vehicle, and the driver's door is closed, a warning buzzer sounds from outside the vehicle.

▣ Keyless Remote Reminder

When the keyless remote is within the system's operational range, and the driver's door is closed, the warning function cancels.

If the keyless remote is taken out of the vehicle after the engine has been started, you can no longer change the **ENGINE START/STOP** button mode or restart the engine. Always make sure if the remote is in your vehicle when you operate the **ENGINE START/STOP** button.

Removing the keyless remote from the vehicle through a window does not activate the warning buzzer.

Do not put the keyless remote on the dashboard or in the glove box. It may cause the warning buzzer to go off. Under some other conditions that can prevent the vehicle from locating the remote, the warning buzzer may also go off even if the remote is within the system's operational range.

Ignition Switch and Power Mode Comparison

Ignition Switch Position	LOCK (0) (with/without the key)	ACCESSORY (I)	ON (II)	START (III)
Without Keyless Access System	<ul style="list-style-type: none"> • Engine is turned off and power is shut down. • The steering wheel is locked. • No electrical components can be used. 	<ul style="list-style-type: none"> • Engine is turned off. • Some electrical components such as the audio system and the accessory power can be operated. 	<ul style="list-style-type: none"> • Normal key position while driving. • All electrical components can be used. 	<ul style="list-style-type: none"> • Use this position to start the engine. • The ignition switch returns to the ON (II) position when you release the key.
Power Mode	VEHICLE OFF (LOCK)	ACCESSORY	ON	START
With Keyless Access System and ENGINE START/STOP Button	Indicator-Off <ul style="list-style-type: none"> • Engine is turned off and power is shut down. • The steering wheel is locked. • No electrical components can be used. 	Indicator-Green <ul style="list-style-type: none"> • Engine is turned off. • Some electrical components such as the audio system and the accessory power socket can be operated. 	Indicator-On (engine is turned off) Indicator-Off (engine is running) <ul style="list-style-type: none"> • All electrical components can be used. 	Indicator-Off <ul style="list-style-type: none"> • The mode automatically returns to ON after the engine starts.

Turn Signals

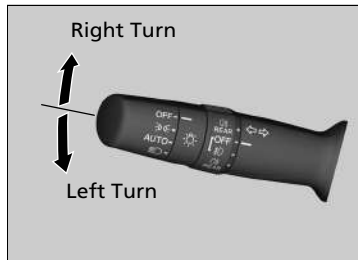

The turn signals can be used when the ignition switch is in ON **II***1.

■ One-push turn signal

When you lightly push up or down and release the turn signal lever, the exterior turn signals and turn signal indicator blink three times.

This feature can be used when signaling for a lane change.

Light Switches

■ Manual Operation

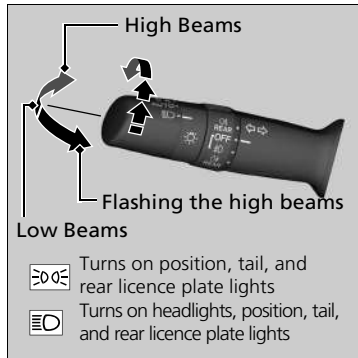

Rotating the light switch turns the lights on and off, regardless of the position of the ignition switch*1.

■ High beams



Push the lever forward until you hear a click.

■ Low beams

When in high beams, pull the lever back to return to low beams.

■ Flashing the high beams

Pull the lever back, and release it.

-  Turns on position, tail, and rear licence plate lights
-  Turns on headlights, position, tail, and rear licence plate lights

*1: Models with the keyless access system have an **ENGINE START/STOP** button instead of an ignition switch.

⌘ Light Switches

If you remove the key from the ignition switch while the lights are on, a chime sounds when the driver's door is opened.

When the lights are on, the lights on indicator in the instrument panel will be on.

➔ **Lights On Indicator** P. 92

■ Models with LED headlights

If you sense that the level of the headlights is abnormal, have your vehicle inspected by a dealer.

Do not leave the lights on when the engine is off because it will cause the battery to discharge.

■ Automatic Lighting Control*

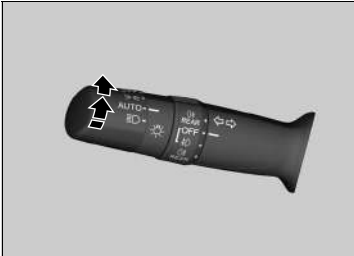

Automatic lighting control can be used when the ignition switch is in ON *1.

When you turn the light switch to **AUTO**, the headlights and other exterior lights will switch on and off automatically depending on the ambient brightness.

*1: Models with the keyless access system have an **ENGINE START/STOP** button instead of an ignition switch.

* Not available on all models

▣ Automatic Lighting Control*

We recommend that you turn on the lights manually when driving at night, in a dense fog, or in dark areas such as long tunnels or parking facilities.

The light sensor is in the location shown below. Do not cover this light sensor with anything; otherwise, the automatic lighting system may not work properly.

Models without lane departure warning

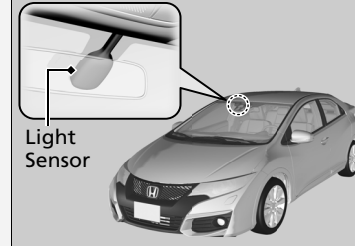

Models with lane departure warning

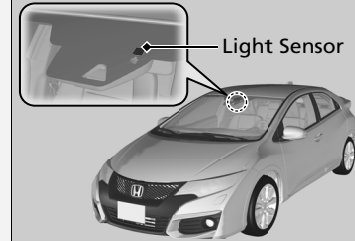

■ Automatic Lighting Off Feature

The headlights, all other exterior lights, and the instrument panel lights turn off 15 seconds after you remove the key or set the power mode to VEHICLE OFF (LOCK), take the remote with you, and close the driver's door. However, when the switch is in , the parking lights remain on.

If you turn the ignition switch to LOCK *1 with the headlight switch on, but do not open the door, the lights turn off after 10 minutes (3 minutes, if the switch is in the **AUTO*** position).

The lights turn on again when you unlock or open the driver's door. If you unlock the door, but do not open it within 15 seconds, the lights go off. If you open the driver's door, you will hear a lights on reminder chime.

*1: Models with the keyless access system have an **ENGINE START/STOP** button instead of an ignition switch.

▣ Automatic Lighting Off Feature

You can change the headlight auto off timer setting.

▣ **Customized Features** P. 131

Fog Lights

■ Front fog lights*

Can be used when the position lights or the headlights are on.

■ Rear fog light

Can be used when the headlights or the front fog lights are on.

■ Front and Rear Fog Lights

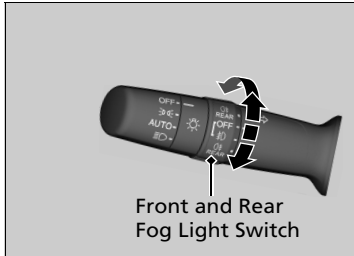

■ To turn the front fog lights on

Rotate the switch up from the **OFF** position to the **FOG** position. The **FOG** indicator comes on.

■ To turn the front and rear fog lights on

Rotate the switch one position up from the **FOG** position. The **FOG** and **REAR FOG** indicators come on.

■ To turn the rear fog light on

Rotate the switch down from the **OFF** position. The **REAR FOG** indicator comes on.

■ Rear Fog Light



- **To turn the rear fog light on**
Rotate the switch to ☁. The ☁ indicator comes on.

Headlight Adjuster*

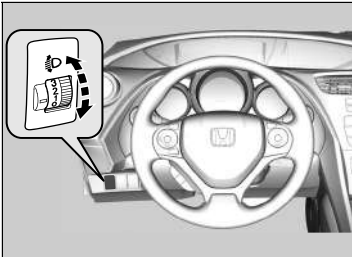

You can adjust the vertical angle of the low beam headlights when the ignition switch is in ON **II***1.

The larger dial number indicates the lower angle.

■ To select the adjusting dial position

Refer to the below table for the appropriate dial position for your vehicle's riding and loading conditions.

Condition	Dial position
A driver	0
A driver and a front passenger	0
Five persons in the front and rear seats	1
Five persons in the front and rear seats and luggage in the luggage area, within the limit of maximum permissible axle weight and maximum permissible vehicle weight	2
A driver and luggage in the luggage area, within the limits of maximum permissible axle weight and maximum permissible vehicle weight	3

*1: Models with the keyless access system have an **ENGINE START/STOP** button instead of an ignition switch.

* Not available on all models

▣ Headlight Adjuster*

Models with LED headlights

Your vehicle is equipped with the automatic headlight adjusting system that automatically adjusts the vertical angle of the low beam headlights. If you find a significant change in the vertical angle of the headlights, there may be a problem with the system. Have your vehicle checked by a dealer.

All models

The headlights are suitable for left hand drive and right hand drive, without the need to make any adjustments or masking, as per UN-ECE R48 Dover Regulation.

High Beam Support System *

Uses the camera attached, monitors the space ahead of your vehicle, and automatically changes the low beam headlights to high beam headlights when necessary.

The system operates when:

- The headlight switch is in **AUTO**.
- The lever is in the low beam position.
- The system recognises that you are driving at night and the low beam headlights come on.
- The vehicle speed is above 40 km/h (25 mph).

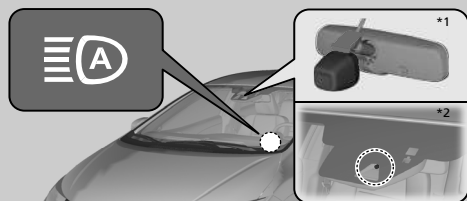

*1: Models without lane departure warning
*2: Models with lane departure warning

The system changes between high and low beam headlights when:

The camera is not detecting any lights coming from preceding or oncoming vehicles: The headlights change to high beams.

The camera detects lights coming from a preceding or oncoming vehicle: The headlights are returned to low beams.

The camera monitors the range within the 30~38-degree view angle. The distance that the camera can detect lights ahead differs depending on conditions, such as the brightness of the lights and the weather.

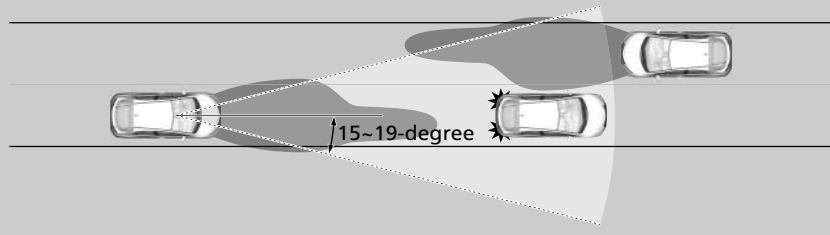

High Beam Support System *

The high beam support system determines when to change the headlight beams by responding to the brightness of the lights ahead of your vehicle. In the following cases, the system may not respond to the lights properly:

- The brightness of the lights from the preceding or oncoming vehicle is intense or poor.
- Visibility is poor due to the weather (rain, snow, fog, windscreen frost, etc.).
- Other light sources, such as streetlights and electric billboards are illuminating the road ahead.
- The brightness level of the road ahead constantly changes.
- The road is bumpy or with many curves.
- A vehicle cuts in front of you, or a vehicle in front of you is not in the preceding or oncoming direction.
- Your vehicle is tilted with a heavy load in the rear.

If you find the timing of beam changes inconvenient for driving, change the headlight beams manually.

If you do not want the system to be activated at any time when the headlight switch is in **AUTO**, consult a dealer.

To Operate the System

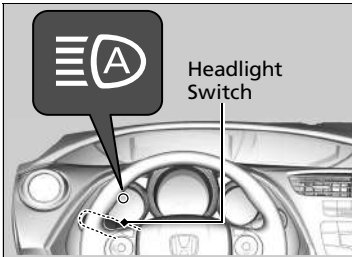

Turn the headlight switch in **AUTO** and pull the headlight lever to low beam.

➤ **Light Switches** P. 174

The high beam support system indicator comes on.

Temporary cancellation

The high beam support system operation is temporarily cancelled while:

- You are continuously driving at a speed below 24 km/h (15 mph).
- The vehicle speed is below 10 km/h (6 mph).
- The windshield wipers run at high speed for more than a few seconds.

The system operation resumes once the condition that caused it to cancel improves.

To Operate the System

For the high beam support system to work properly:

- Do not place an object that reflects light on the dashboard.
- Keep the windshield around the camera clean. When cleaning the windshield, be careful not to apply the windshield cleanser to the camera lens.
- Do not attach an object, sticker or film in the area around the camera.
- Do not touch the camera lens.

If the camera receives a strong impact, or repairing of the area near the camera is required, consult a dealer.

To help reduce the likelihood that high interior temperatures will cause the camera system to shut off, when parking, find a shady area or face the front of the vehicle away from the sun.

If you use a reflective sun shade, do not allow it to cover the camera housing. Covering the camera can concentrate heat on the camera.

Models with lane departure warning

If the **Can Not Operate:**  message appears:

- Use the climate control system to cool down the interior and, if necessary, the demister mode when windows are fogged.
- Start driving the vehicle to lower the windshield temperature, which cools down the area around the camera.

■ To manually cancel the temporarily

You can cancel the operation when you manually change the headlights to high beams. Push the lever forward until you hear a click, or lightly pull the lever towards you to flash high beams. The high beam support system indicator goes off.

If you want the high beam support system operation to resume at once, pull and hold the lever towards you for a few seconds.

Daytime Running Lights

The daytime running lights come on when the following conditions have been met:

- The ignition switch is in ON ^{*1}.
- The headlight switch is off.

*1: Models with the keyless access system have an **ENGINE START/STOP** button instead of an ignition switch.

🔗 To Operate the System

If the  message appears:

- Park your vehicle in a safe place, and clean the windshield. If the message does not disappear after you have cleaned the windshield and driven for a while, have your vehicle checked by a dealer.

Models with lane departure warning

If the **Can Not Operate:**  message appears:

Park your vehicle in a safe place. Wipe away debris blocking the windshield, then start driving again. If the message remains on even after driving for a while with the clean windshield, have your vehicle checked by a dealer.

Wipers and Washers

Windscreen Wipers/Washers

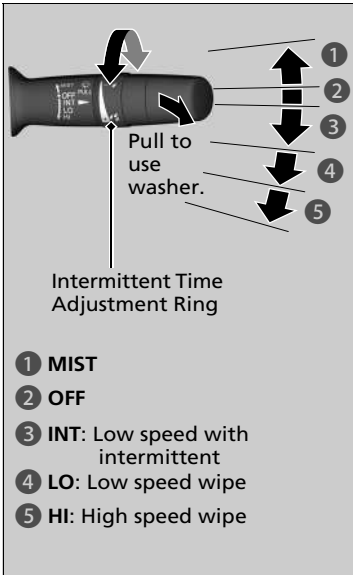

- 1 MIST
- 2 OFF
- 3 INT: Low speed with intermittent
- 4 LO: Low speed wipe
- 5 HI: High speed wipe

The windscreen wipers and washers can be used when the ignition switch is in ON (II)*1.

■ MIST

The wipers run at high speed until you release the lever.

■ Wiper switch (OFF, INT*, LO, HI)

Change the wiper switch setting according to the amount of rain.

■ AUTO*

🔘 Automatic Intermittent Wipers* P. 184

■ Adjusting wiper operation

Turn the adjustment ring to adjust wiper operation.



Lower speed, fewer sweeps

Higher speed, more sweeps

■ Washer

Sprays while you pull the lever towards you. When you release the lever for more than one second, the spray stops, the wipers sweep two or three more times to clear the windscreen, then stop.

*1: Models with the keyless access system have an **ENGINE START/STOP** button instead of an ignition switch.

* Not available on all models

Continued

Wipers and Washers

NOTICE

Do not use the wipers when the windscreen is dry. The windscreen will get scratched, or the rubber blades will get damaged.

NOTICE

In cold weather, the blades may freeze to the windscreen, becoming stuck. Operating the wipers in this condition may damage the wipers. Use the demister to warm the windscreen, then turn the wipers on.

If the vehicle speeds up while the wipers are operating intermittently, the length of the wipe interval shortens. When the vehicle starts moving, the wipers make a single sweep. When the vehicle speeds up, the wiper operation's shortest delay setting (🔘) and the **LO** setting become the same.

Turn the washers off if no washer fluid comes out. The pump may get damaged.

Automatic Intermittent Wipers*

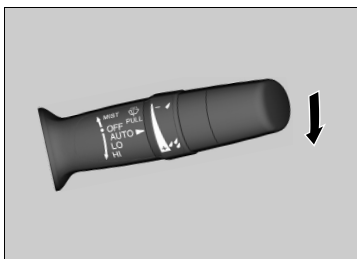

When you push the lever down to **AUTO**, the windscreen wipers sweep once, and go into the automatic mode.

The wipers operate intermittently, at low speed, or at high speed and stops in accordance with the amount of rainfall the rainfall sensor detects.

AUTO sensitivity adjustment

When in **AUTO**, you can also adjust the rainfall sensor sensitivity using the intermittent time adjustment ring.

Sensor sensitivity



Low sensitivity:
Lower speed, fewer sweeps

High sensitivity:
Higher speed, more sweeps

Automatic Intermittent Wipers*

The rainfall sensor is in the location shown below.

Models without lane departure warning



Models with lane departure warning

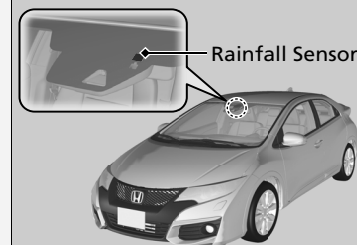

Do not put the wiper lever in **AUTO** when cleaning the windscreen or driving through a car wash. If the wiper lever is in **AUTO**, and the ignition switch is in ON **II**^{*1}, the rainfall sensor may respond to your hand or car wash liquids, and the wipers may operate automatically.

*1: Models with the keyless access system have an **ENGINE START/STOP** button instead of an ignition switch.

■ Rear Wiper/Washer*

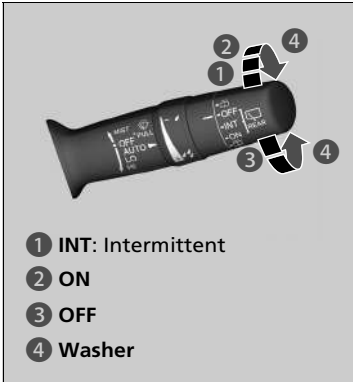

The rear wiper and washer can be used when the ignition switch is in ON **II***1.

■ Wiper switch (OFF, INT, ON)

The wiper operates intermittently after completing a few sweeps.

■ Washer (🚿)

Sprays while you rotate the switch to this position.

When you release the lever for more than one second, the spray stops, the wipers sweep two or three more times to clear the windscreen, then stop.

■ Operating in reverse

When you shift the transmission to **R** with the windscreen wipers activated, the rear wiper operates automatically as follows even if its switch is off.

Front Wiper Position	Rear Wiper Operation
INT (Intermittent)	Intermittent
LO (Low speed wipe)	Continuous
HI (High speed wipe)	

*1: Models with the keyless access system have an **ENGINE START/STOP** button instead of an ignition switch.

* Not available on all models

Continued

▣ Rear Wiper/Washer*

If the wiper stops operating due to any obstacle such as the build-up of snow, park the vehicle in a safe place.

Rotate the wiper switch to OFF, and turn the ignition switch to ACCESSORY **I** or LOCK **0***1, then remove the obstacle.

The wiper motor is equipped with a breaker that may stop motor operation temporarily to prevent an overload. Wiper operation resumes within a few minutes once the circuit has returned to normal.

*1: Models with the keyless access system have an **ENGINE START/STOP** button instead of an ignition switch.

Headlight Washers*

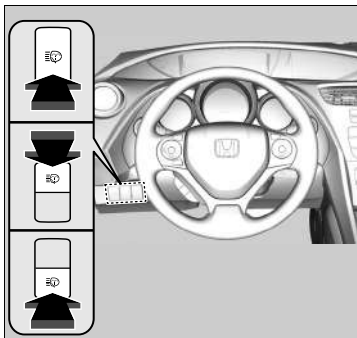

Turn the headlights on and press the headlight washers button to operate. The headlight washers also operate when you turn the windscreen washers for the first time after the ignition switch is turned to ON *1.

Headlight Washers*

The headlight washers use the same fluid reservoir as the windscreen washers.

*1: Models with the keyless access system have an **ENGINE START/STOP** button instead of an ignition switch.

* Not available on all models

Brightness Control

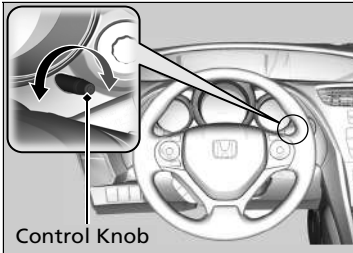

Control Knob

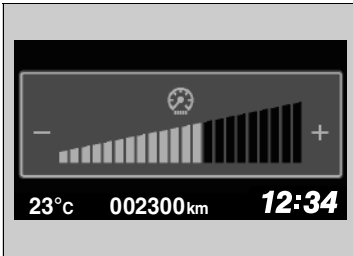

When the ignition switch is in ON *1, you can use the brightness control knob to adjust instrument panel brightness.

Brighten: Turn the knob to the right.

Dim: Turn the knob to the left.



The i-multi-information display will return to its original state several seconds after you adjust the brightness.

■ Brightness level indicator

The brightness level is shown on the i-multi-information display while you are adjusting it.

► Brightness Control

Instrument panel brightness differs between when the exterior lights are on and when they are off. The instrument panel dims to reduce glare when the lights are on.

Pressing the  (Select/Reset) Knob or the  (display/information) button changes to a different display.

Turn the knob to the right until the brightness display is up to max. This cancels the reduced instrument panel brightness when the lights are on.

The brightness can be set differently for when the lights are on, and when they are off.

*1: Models with the keyless access system have an **ENGINE START/STOP** button instead of an ignition switch.

Rear Demister/Heated Door Mirror* Button

Press the rear demister and heated door mirror button to defog the rear window and mirrors when the ignition switch is in ON ^{*1}.

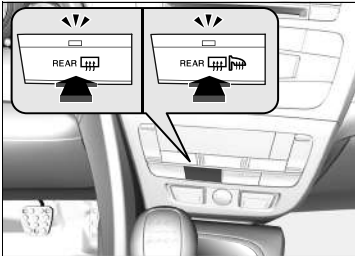

The rear demister and heated door mirrors automatically switch off after 10-30 minutes depending on the outside temperature. However, if the outside temperature is 0°C or below, they do not automatically switch off.

▶ Rear Demister/Heated Door Mirror* Button

NOTICE

When cleaning the inside of the rear window, be careful not to damage the heating wires. It is critical to wipe the window from side to side along the demister heating wires.

This system consumes a lot of power, and may weaken the battery, making it difficult to start the engine. Turn it off when the window has been defogged. Also, do not use the system for a long period even if the engine is idling.

*1: Models with the keyless access system have an **ENGINE START/STOP** button instead of an ignition switch.

* Not available on all models

Adjusting the Steering Wheel

The steering wheel height and distance from your body can be adjusted so that you can comfortably grip the steering wheel in an appropriate driving posture.

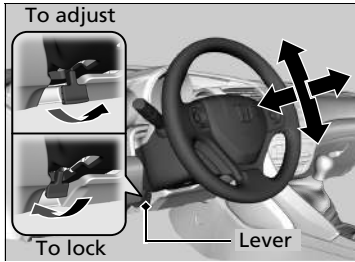

1. Pull the steering wheel adjustment lever up.
 - The steering wheel adjustment lever is under the steering column.
2. Move the steering wheel up or down, and in or out.
 - Make sure you can see the instrument panel gauges and indicators.
3. Push the steering wheel adjustment lever down to lock the steering wheel in position.
 - After adjusting the position, make sure you have securely locked the steering wheel in place by trying to move it up, down, in, and out.

Adjusting the Steering Wheel

⚠ WARNING

Adjusting the steering wheel position while driving may cause you to lose control of the vehicle and be seriously injured in a crash.

Adjust the steering wheel only when the vehicle is stopped.

Make any steering wheel adjustments before you start driving.

Adjusting the Mirrors

Interior Rearview Mirror

Adjust the angle of the rearview mirror when you are sitting in the correct driving position.

Rearview Mirror with Day and Night Positions*

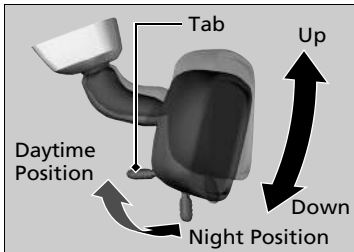

Dimming the rearview mirror

Flip the tab to switch the position. The night position helps to reduce the glare from headlights behind you when driving after dark.

Automatic Dimming Rearview Mirror*

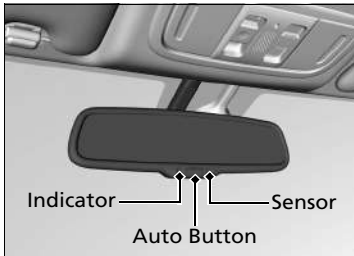

Reduces the glare from headlights behind you when driving after dark. Press the auto button to turn this function on and off. When activated, the auto indicator comes on.

Adjusting the Mirrors

Keep the inside and outside mirrors clean and adjusted for best visibility.

Adjust the mirrors before you start driving.

➤ **Adjusting the Seat Positions** P. 193

Automatic Dimming Rearview Mirror*

The auto dimming function cancels when the shift position is in **R**.

Power Door Mirrors*

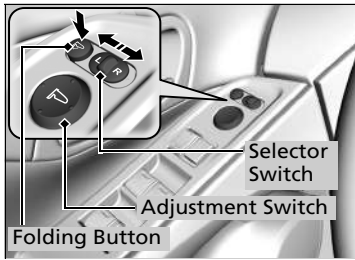

You can adjust the door mirrors when the ignition switch is in ON ^{*1}.

■ Mirror position adjustment

L/R selector switch: Select the left or right mirror. After adjusting the mirror, return the switch to the centre position.

Mirror position adjustment switch: Press the switch left, right, up, or down to move the mirror.

■ Folding door mirrors*

Press the folding button to fold in and out the door mirrors.

* Not available on all models

Automatic Folding Door Mirror Function*

■ Folding in the door mirrors

Press the LOCK button on the remote transmitter or keyless remote twice within 10 seconds, and hold it.

- ▶ You can release the button once the mirrors start folding in automatically.

Models with keyless access system

Press the door lock button on either front outside door handle or the tailgate twice within 10 seconds, and hold it.

- ▶ You can release the button once the mirrors start folding in automatically.

■ Folding out the door mirrors

Unlock all doors and the tailgate using the remote transmitter. Open the driver's door.

- ▶ The mirrors start folding out automatically.

Models with keyless access system

Grab either front outside door handle or press the tailgate release button and unlock all doors and the tailgate. Open the driver's door.

- ▶ The mirrors start folding out automatically.

▶▶ Folding out the door mirrors

The door mirrors do not fold out automatically if they have been folded in using the folding button.

*1: Models with the keyless access system have an **ENGINE START/STOP** button instead of an ignition switch.

* Not available on all models

Adjusting the Seat Positions

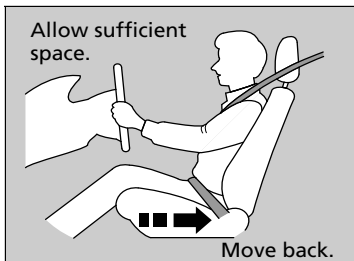

Adjust the driver's seat as far back as possible while allowing you to maintain full control of the vehicle. You should be able to sit upright, well back in the seat and be able to adequately press the pedals without leaning forward, and grip the steering wheel comfortably. The passenger's seat should be adjusted in a similar manner, so that it is as far back from the front airbag in the dashboard as possible.

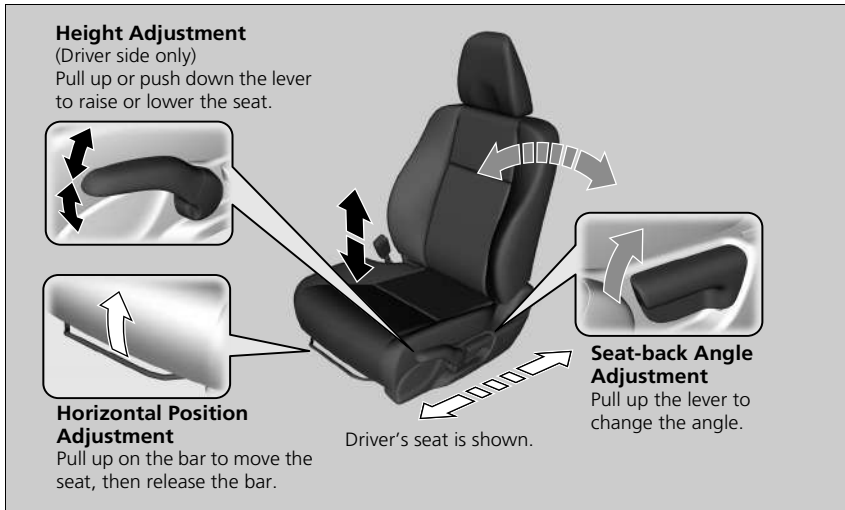

Adjusting the Seats

WARNING

Sitting too close to a front airbag can result in serious injury or death if the front airbags inflate.

Always sit as far back from the front airbags as possible while maintaining control of the vehicle.

Allow at least 25 cm (10 inches) between the centre of the steering wheel and the chest.

Always make seat adjustments before driving.

Once a seat is adjusted correctly, rock it back and forth to make sure it is locked in position.

Continued

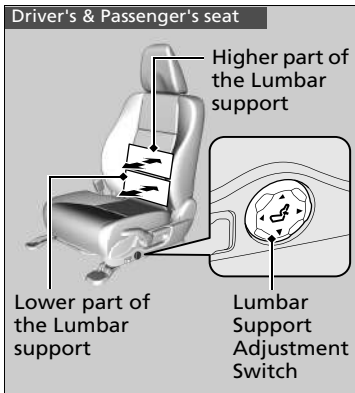

■ **Lumbar support adjustment switch***

Press the top: To increase the higher part of the lumbar support.

Press the bottom: To increase the lower part of the lumbar support. (the higher part support is decreased)

Press the front: To increase the entire lumbar support.

Press the rear: To decrease the entire lumbar support.

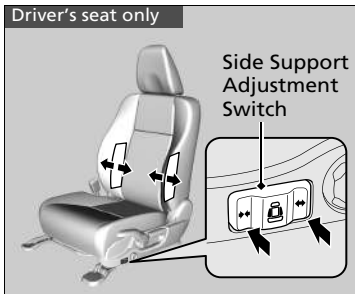

■ **Side support adjustment switch***

Adjusts the amount of the side support.

■ Adjusting the Seat-Backs

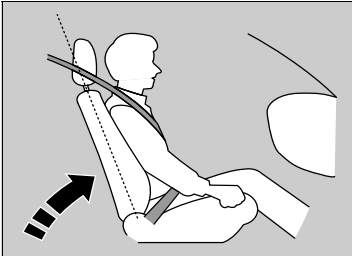

Adjust the driver's seat-back to a comfortable, upright position, leaving ample space between your chest and the airbag cover in the centre of the steering wheel.

The front seat passenger should also adjust their seat-back to a comfortable, upright position.

Reclining a seat-back so that the shoulder part of the belt no longer rests against the occupant's chest reduces the protective capability of the belt. It also increases the chance of sliding under the belt in a crash and being seriously injured. The farther a seat-back is reclined, the greater the risk of injury.

▣ Adjusting the Seat-Backs

⚠ WARNING

Reclining the seat-back too far can result in serious injury or death in a crash.

Adjust the seat-back to an upright position, and sit well back in the seat.

Do not put a cushion, or other object, between the seat-back and your back.

Doing so may interfere with proper seat belt or airbag operation.

If you cannot get far enough away from the steering wheel and still reach the controls, we recommend that you investigate whether some type of adaptive equipment may help.

■ Adjusting the Head Restraints*

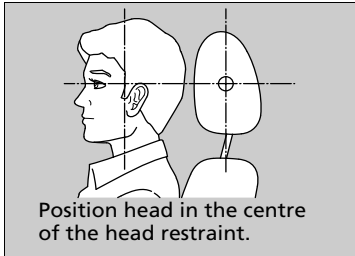

Your vehicle is equipped with head restraints in all seating positions.

Head restraints are most effective for protection against whiplash and other rear-impact crash injuries when the centre of the back of the occupant's head rests against the centre of the restraint. The tops of the occupant's ears should be level with the centre height of the restraint.

■ Adjusting the front head restraint positions

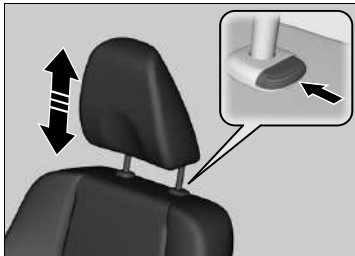

To raise the head restraint:

Pull it upward.

To lower the head restraint:

Push it down while pressing the release button.

► Adjusting the Head Restraints*

⚠ WARNING

Improperly positioning head restraints reduces their effectiveness and increases the likelihood of serious injury in a crash.

Make sure head restraints are in place and positioned properly before driving.

In order for the head restraint system to work properly:

- Do not hang any items on the head restraints, or from the restraint legs.
- Do not place any objects between an occupant and the seat-back.
- Install each restraint in its proper location.

■ Changing the Rear Center* and Rear Outer Seat Head Restraint Positions

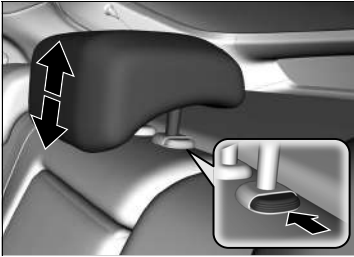

A passenger sitting in a back seating position should adjust the height of their head restraint to an appropriate position before the vehicle begins moving.

To raise the head restraint:

Pull it upward.

To lower the head restraint:

Push it down while pressing the release button.

■ Removing and Reinstalling the Head Restraints

Head restraints can be removed for cleaning or repair.

To remove the head restraint:

Pull the restraint up as far as it will go. Then push the release button, and pull the restraint up and out.

To reinstall the head restraint:

Insert the legs back in place, then adjust the head restraint to an appropriate height while pressing the release button. Pull up on the restraint to make sure it is locked in position.

▣ Changing the Rear Center* and Rear Outer Seat Head Restraint Positions

When you use the head restraint in a rear seating position, pull up the head restraint to its highest position. Do not use it in any lower position.

▣ Removing and Reinstalling the Head Restraints

⚠ WARNING

Failure to reinstall, or correctly reinstall, the head restraints can result in severe injury during a crash.

Always replace the head restraints before driving.

* Not available on all models

■ Maintain a Proper Sitting Position

After all occupants have adjusted their seats and head restraints, and put on their seat belts, it is very important that they continue to sit upright, well back in their seats, with their feet on the floor until the vehicle is safely parked and the engine is off.

Sitting improperly can increase the chance of injury during a crash. For example, if an occupant slouches, lies down, turns sideways, sits forward, leans forward or sideways, or puts one or both feet up, the chance of injury during a crash is greatly increased.

In addition, an occupant who is out of position in the front seat can be seriously or fatally injured in a crash by striking interior parts of the vehicle or being struck by an inflating front airbag.

⚠ Maintain a Proper Sitting Position

⚠ WARNING

Sitting improperly or out of position can result in serious injury or death in a crash.

Always sit upright, well back in the seat, with your feet on the floor.

Rear Seats

Folding Down the Rear Seats

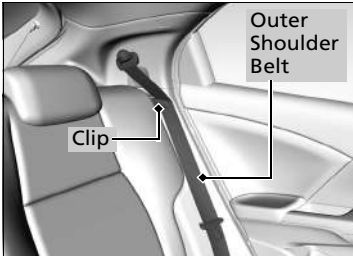

1. Store the armrest* in the seat-back.
2. Put the outer shoulder belt in the clip on each side.

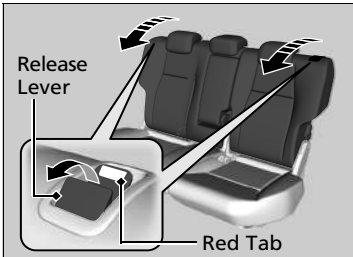

3. Lower the head restraints to their lowest positions.
4. Pull the release lever and fold down the seat-back.

Folding Down the Rear Seats

⚠ WARNING

Make sure the seat-backs are latched securely before driving.

The rear seat-backs can be folded down to accommodate bulkier items in the luggage area.

Never drive with the seat-back folded down and the tailgate open.

⚠ Exhaust Gas Hazard P. 79

To lock a seat-back upright, push it backwards until it locks, so that the red tabs in the release lever go down.

When returning the seat-back to its original position, push it firmly back. Also, make sure all rear shoulder belts are positioned in front of the seat-back.

Make sure all items in the luggage area or items extending through the opening into the rear seats are properly secured. Loose items can fly forward if you have to brake hard.

* Not available on all models

Continued

■ Folding Up the Rear Seat*

Separately lift up the left and right rear seat cushions to make room for luggage.

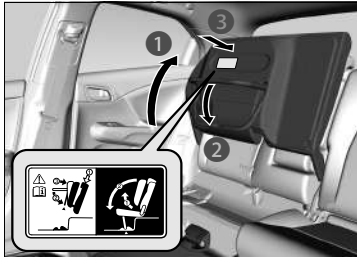

1. Store the armrest* in the seat-back.
2. Put the outer shoulder belt in the clip on each side.

➤ Folding Down the Rear Seats P. 199

3. Lower each head restraint to its lowest position.
4. Pull up the rear seat cushion.
5. Fold the seat leg down.
6. Push the seat cushion firmly against the seat-back to lock it.

■ Putting the seat in the original position

1. Hold the seat cushion in the upright position, and pull up the seat leg fully.
 - ▶ The seat cushion can abruptly fall down once you pull up the seat leg.
2. Slowly put down the seat cushion and set the seat leg in the floor guide.
 - ▶ A latch comes out when the leg is set properly.

➤ Folding Up the Rear Seat*

After you fold the seat up, or put it back in the original position, make sure the seat is firmly secured by rocking it forward and back.

Check if there are any items on the seat before you pull the seat cushion up. Check if there are any obstacles around the floor guide before you put the seat back in the original position.

Armrest

■ Using the Front Seat Armrest



The console lid can be used as an armrest.

■ Using the Rear Seat Armrest*

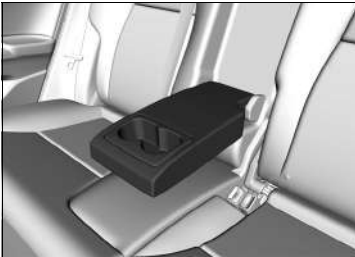

Pull down the armrest in the centre seat-back.

* Not available on all models

Interior Lights

Interior Light Switches

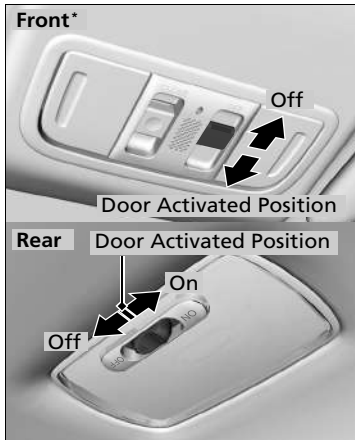

■ ON

The interior lights come on regardless of whether the doors are open or closed.

■ Door activated

The interior lights come on in the following situations:

- When any of the doors are opened.
- You unlock the driver's door.
- You remove the key from the ignition switch.

Models with keyless access system

- When you turn the **ENGINE START/STOP** button to OFF.

■ OFF

The interior lights remain off regardless of whether the doors are open or closed.

Interior Light Switches

In the door activated position, the interior lights fade out and go off about 30 seconds after the doors are closed.

The lights go off after 30 seconds in the following situations:

- When you unlock the driver's door but do not open it.
- When you remove the key from the ignition switch but do not open a door.

The interior lights go off immediately in the following situations:

- When you lock the driver's door.
- When you close the driver's door with the key in the ignition switch.
- When you turn the ignition switch to ON **II***1.

If you leave any of the doors open without the key in the ignition switch, the interior lights go off after about 15 minutes.

If you leave tailgate open without the key in the ignition switch, the luggage area light goes off after about 30 minutes.

*1: Models with the keyless access system have an **ENGINE START/STOP** button instead of an ignition switch.

■ Map Lights *

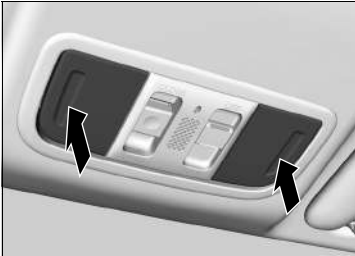

The map lights can be turned on and off by pressing the lenses.

»» Map Lights *

Models with front interior light switch

When the front interior light switch is in the door activated position and any door is open, pressing the lens does not turn off the map light.

* Not available on all models

Interior Convenience Items

■ Glove Box

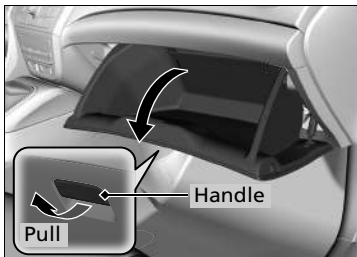

Pull the handle to open the glove box.

■ Console Compartment



Pull the handle to open the console compartment.

☒ Glove Box

⚠ WARNING

An open glove box can cause serious injury to your passenger in a crash, even if the passenger is wearing the seat belt.

Always keep the glove box closed while driving.

You can use the band to hold the owner's manual.

Beverage Holders

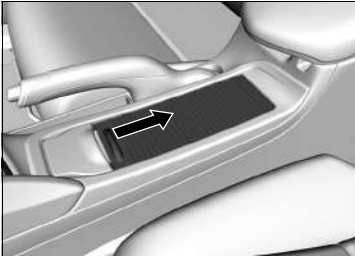

■ Front seat beverage holders with lid

To open the beverage holder, slide the lid rearward.

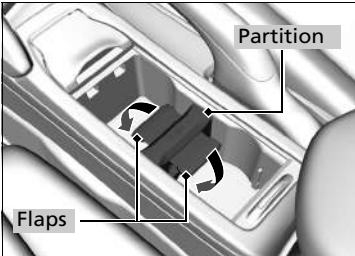

Models with partition

You can remove the partition to get more space.

1. Push the flaps down to fold them until they latch.

- Pushing the top of the partition unlatches the flaps.

☒ Beverage Holders

NOTICE

Spilled liquids can damage the upholstery, carpeting, and electrical components in the interior.

Be careful when you are using the beverage holders. Hot liquid can scald you.

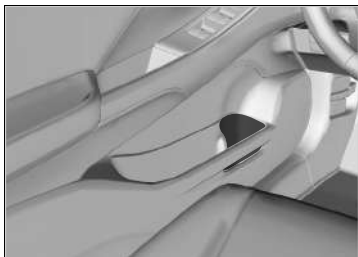
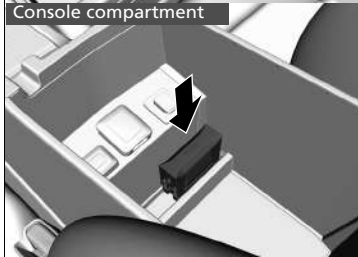
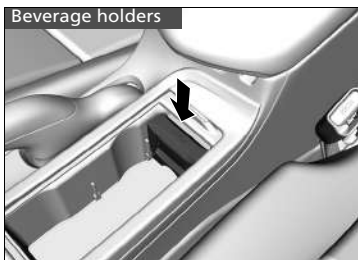

2. Pull the partition to remove it. Store the partition as shown.

■ Front door beverage holders

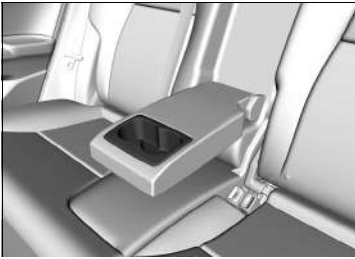

■ **Rear seat beverage holders***

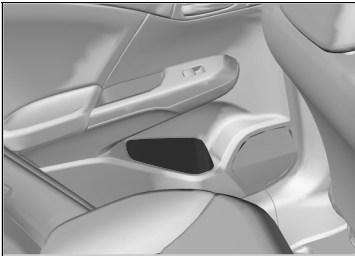

Fold the armrest down to use the rear seat beverage holders.



■ **Rear door beverage holders**

* Not available on all models

Accessory Power Sockets

The accessory power sockets can be used when the ignition switch is in ACCESSORY  or ON *1.



Accessory power socket on the console panel

Open the cover to use it.

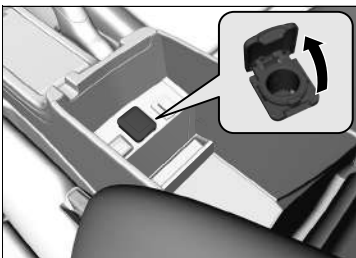

Accessory power socket in the console compartment*

Open the console lid and the cover to use it.

Accessory Power Sockets

NOTICE

Do not insert an automotive type cigarette lighter element.

This can overheat the power socket.

The accessory power sockets are designed to supply power for 12 volt DC accessories that are rated 180 watts or less (15 amps).

When each socket is being used simultaneously, the combined power rating of the accessories should not exceed 180 watts (15 amps).

To prevent battery drain, only use the power socket with the engine running.

*1: Models with the keyless access system have an **ENGINE START/STOP** button instead of an ignition switch.

* Not available on all models

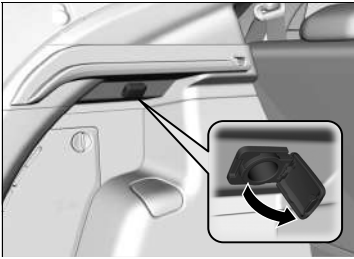

■ **Accessory power socket in the luggage area***

Open the cover to use it.

■ **Coat Hooks**



There are coat hooks on the left and right door pillars.

☒ **Coat Hooks**

The coat hooks are not designed for large or heavy items.

* Not available on all models

Continued

■ Luggage Hooks

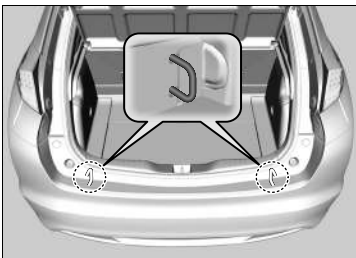

The luggage hooks in the luggage area can be used to install a net for securing items.

■ Side Storage Compartment*

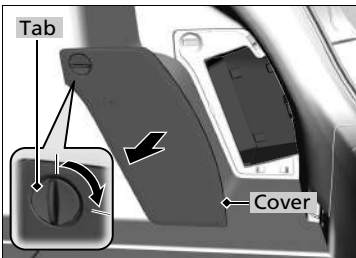

Turn and pull the tab to open the compartment cover located on the side of the luggage area.

■ Under-Floor Storage Area*

You can either open or lower the luggage area floor lid to use the under-floor storage area.

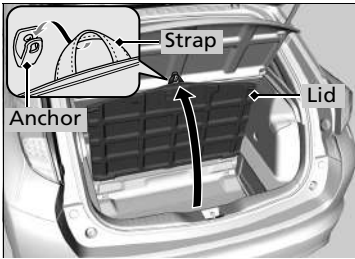

■ Storing items with the lid open

1. Open the tailgate.
2. Pull the strap and open the lid.
3. Hook the strap to the anchor as shown.

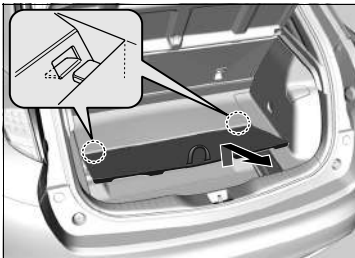

■ Storing items on the lid at the bottom

This is convenient when storing a tall item.

1. Pull the strap and open the lid.
2. Pull the lid towards you until it disengages from the support rods.

* Not available on all models

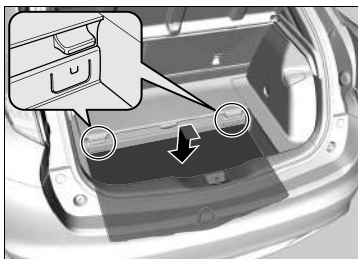

3. Push the far end of the lid down to the bottom of the under-floor storage area, then lower the other end.

■ Luggage Area Cover*

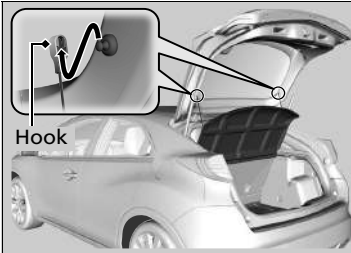

■ Removing the luggage area cover

1. Open the tailgate
2. Remove the hooks.
3. Pull the cover towards you until it disengages from the support rods, and lift it up to remove.

▣ Luggage Area Cover*

Do not put any objects on the luggage area cover. It may interfere with the driver's rear view, and the items on the cover can fly around during a hard braking.

* Not available on all models

Continued

Seat Heaters*



The ignition switch must be in ON **II***¹ to use the seat heaters. The **HI** setting heats the seats faster than the **LO** setting.

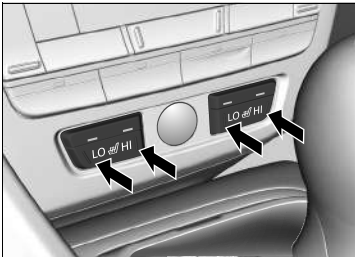

The indicator for your setting comes on while the seat heater is in use. Briefly press the button on the opposite side to turn the heater off. The indicator goes off. While in **HI**, the heater cycles on and off. When a comfortable temperature is reached, select **LO** to keep the seat warm.

*1: Models with the keyless access system have an **ENGINE START/STOP** button instead of an ignition switch.

* Not available on all models

Seat Heaters*

WARNING

Heat induced burns are possible when using seat heaters.

Persons with a diminished ability to sense temperature (e.g., persons with diabetes, lower-limb nerve damage, or paralysis) or with sensitive skin should not use seat heaters.

Do not use the seat heaters even in **LO** when the engine is off. Under such conditions, the battery may be weakened, making the engine difficult to start.

In the **LO** setting, the heater runs continuously and does not automatically turn off.

Climate Control System*

Models with synchronized mode

Using Automatic Climate Control

The automatic climate control system maintains the interior temperature you select. The system also selects the proper mix of heated or cooled air that raises or lowers the interior temperature to your preference as quickly as possible.

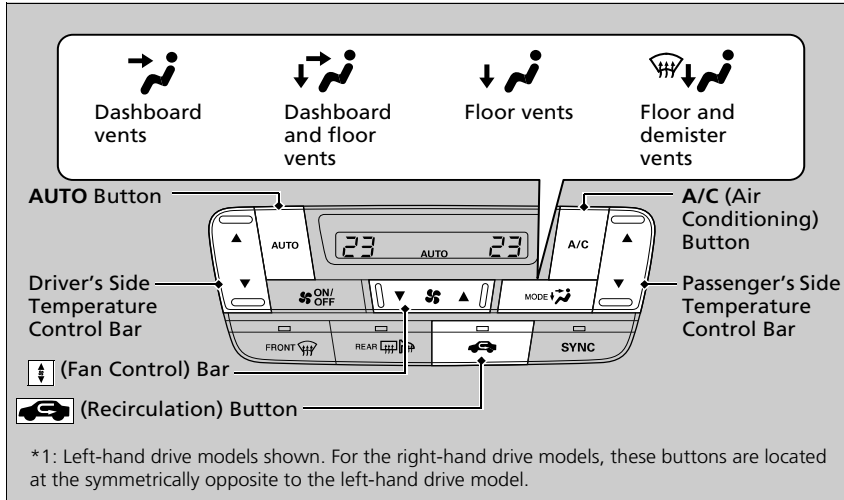

Use the system when the engine is running.

1. Press the **AUTO** button.
2. Adjust the interior temperature using the driver's side or passenger's side temperature control bar.
3. Press the **ON/OFF** button to cancel.

* Not available on all models

Using Automatic Climate Control

If any button is pressed while in **AUTO**, the function of that button takes priority. The **AUTO** indicator goes off, but functions of other buttons pressed are still in auto mode.

To prevent cold air from blowing in from outside, the fan may not start immediately when the **AUTO** button is pressed.

Models with Auto Idle Stop

During Auto Idle Stop, the air conditioning system will be turned off.

Once you have set the desired temperature, do not use the temperature control switches more than necessary.

Doing so may delay the time it takes to reach the set temperature.

If the interior is very warm, you can cool it down more rapidly by partially opening the windows, turning the system on **AUTO**. Change the fresh air mode to recirculation mode until the temperature cools down.

When you set the temperature to the lower or upper limit, **Lo** or **Hi** is displayed.

Continued

■ Switching between the recirculation and fresh air modes

Press the  button and switch the mode depending on environmental conditions.

Recirculation mode (indicator on): Recirculates air from the vehicle's interior through the system.

Fresh air mode (indicator off): Maintains outside ventilation. Keep the system in fresh air mode in normal situations.

■ Defrosting the Windscreen and Windows

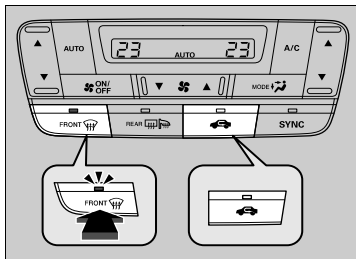

Pressing the  button turns the air conditioning system on and automatically switches the system to fresh air mode.

Pressing the  button again to turn the air conditioning system off. The climate control system returns to the previous settings.

■ To rapidly defrost or defog the windows

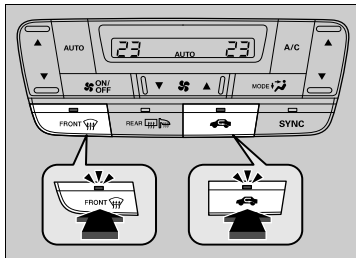

1. Press the  button.
2. Press the  button.

►► Using Automatic Climate Control

Pressing the  button switches the climate control system between on and off. When turned on, the system returns to your last selection.

Models with ECON system

While in ECON mode, the system has greater temperature fluctuations.

►► Defrosting the Windscreen and Windows

For your safety, make sure you have a clear view through all the windows before driving.

Do not set the temperature near the upper or lower limit.

When cold air hits the windscreen, the outside of the windscreen may fog up.

If the side windows fog up, adjust the vents so that the air hits the side windows.

►► To rapidly defrost or defog the windows

After defrosting the windows, switch over to fresh air mode. If you keep the system in recirculation mode, the windows may fog up from humidity. This impedes visibility.

■ Synchronized Mode

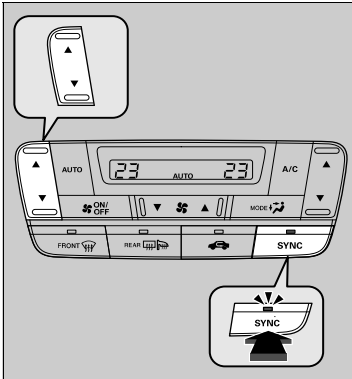

You can set the temperature synchronously for the driver side and the passenger side in synchronized mode.

1. Press the **SYNC** button.
 - The system switches to synchronized mode.
2. Adjust the temperature using driver's side temperature control bar.

Press the **SYNC** button or change the passenger side temperature setting to return to dual mode.

☒ Synchronized Mode

When the system is in dual mode, the driver side temperature and the passenger side temperature can be set separately.

Models without synchronized mode

Using Automatic Climate Control

The automatic climate control system maintains the interior temperature you select.

Models with air conditioning system

The system also selects the proper mix of heated or cooled air that raises or lowers the interior temperature to your preference as quickly as possible.

Models without air conditioning system

The system also selects the proper mix of heated or outside air that raises or lowers the interior temperature to your preference.

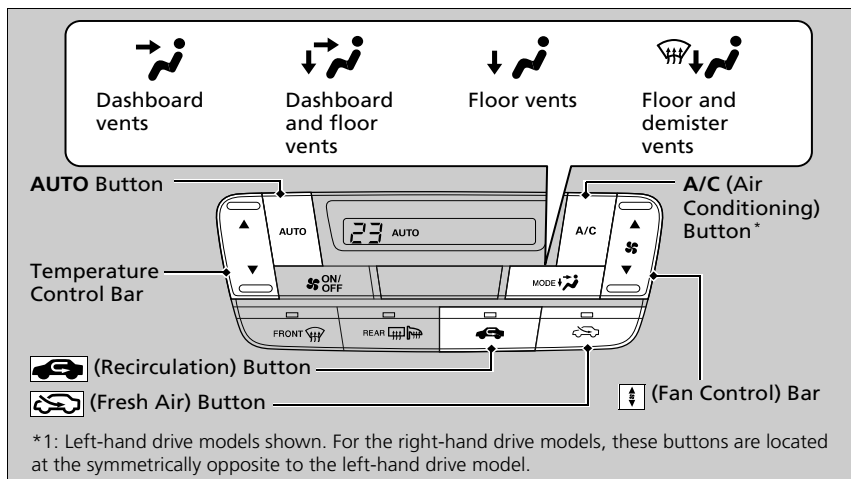

* 1: Left-hand drive models shown. For the right-hand drive models, these buttons are located at the symmetrically opposite to the left-hand drive model.

Use the system when the engine is running.

1. Press the **AUTO** button.
2. Adjust the interior temperature using the temperature control bar.
3. Press the **ON/OFF** button to cancel.

* Not available on all models

►► Using Automatic Climate Control

If any buttons is pressed while in **AUTO**, the function of that button takes priority. The **AUTO** indicator goes off, but functions of other buttons pressed still in auto mode.

Models with Auto Idle Stop

During Auto Idle Stop, the air conditioning system will be turned off.

To prevent cold air from blowing in from outside, the fan may not start immediately when the **AUTO** button is pressed.

Once you have set the desired temperature, do not use the temperature control switches more than necessary. Doing so may delay the time it takes to reach the set temperature.



When you set the temperature to the lower or upper limit, **Lo** or **Hi** is displayed.

Pressing the **ON/OFF** button switches the climate control system between on and off. When turned on, the system returns to your last selection.

Models with ECON system

While in ECON mode, the system has greater temperature fluctuations.

■ Switching between the recirculation and fresh air modes

Press the  (Recirculation) button or  (Fresh air) button switch the mode depending on environmental conditions.

Recirculation mode: Recirculates air from the vehicle's interior through the system.

Fresh air mode: Maintains outside ventilation. Keep the system in fresh air mode in normal situations.

■ Defrosting the Windscreen and Windows

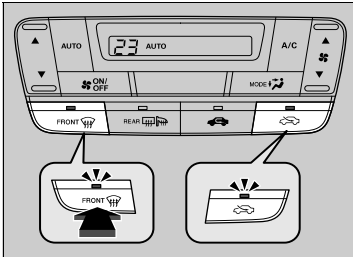



Models with air conditioning system

Pressing the  button turns the air conditioning system on and automatically switches the system to fresh air mode.

Pressing the  button again to turn the air conditioning system off. The climate control system returns to the previous settings.

Models without air conditioning system

Pressing the  button automatically switches the system to fresh air mode.

Pressing the  button again to turn the system off. The climate control system returns to the previous settings.

►► Using Automatic Climate Control

Models with air conditioning system

If the interior is very warm, you can cool it down more rapidly by partially opening the windows, turning the system on **AUTO**. Change the fresh air mode to recirculation mode until the temperature cools down.

►► Defrosting the Windscreen and Windows

For your safety, make sure you have a clear view through all the windows before driving.

Models with air conditioning system

Do not set the temperature near the upper or lower limit.

When cold air hits the windscreen, the outside of the windscreen may fog up.

If the side windows fog up, adjust the vents so that the air hits the side windows.

Models without air conditioning system

Your vehicle does not have an air compressor. This may cause inside the windows to fog up.

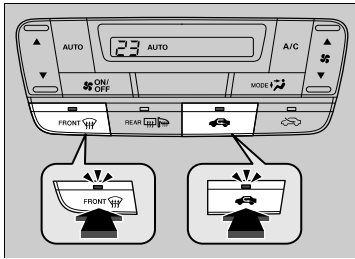

■ **To rapidly defrost or defog the windows**

1. Press the  button.
2. Press the  button.

▣ **To rapidly defrost or defog the windows**

After defrosting the windows, switch over to fresh air mode. If you keep the system in recirculation mode, the windows may fog up from humidity. This impedes visibility.

Automatic Climate Control Sensors

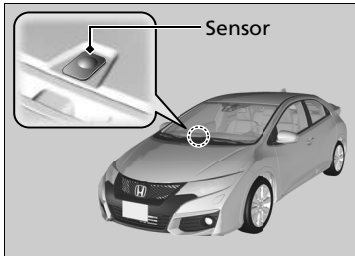

The automatic climate control system is equipped with sensors. Do not cover or spill any liquid on them.

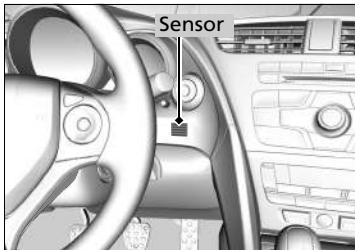

Features

This chapter describes how to operate technology features.

Audio System*	
About Your Audio System	222
USB Port(s)	223
HDMI™ Port*	224
Auxiliary Input Jack*	224
Audio System Theft Protection	225
Audio Antenna*	226
Audio Remote Controls	227
Models with one display	
Audio System Basic Operation	229
Models with two displays	
Audio System Basic Operation	257

Audio Error Messages*	
CD Player*	304
iPod/USB Flash Drive	305
Android/Apps	307
General Information on the Audio System	
Recommended CDs*	308
Compatible iPod, iPhone, and USB Flash Drives	310
About Open Source Licences	312
Customized Features	
Defaulting All the Settings	328

Models with one display	
Hands-Free Telephone System*	
Using HFT	329
HFT Menus	331
Models with two displays	
Hands-Free Telephone System	
Using HFT	353
HFT Menus	356

* Not available on all models

About Your Audio System

Models with navigation system

See the Navigation System Manual for operation on the navigation system.

Models without navigation system

The audio system features AM/FM radio. It can also play audio CDs*, WMA*/MP3*/AAC* files, USB flash drives, and iPod, iPhone, and *Bluetooth*® devices.

You can operate the audio system from the buttons and switches on the panel, or the remote controls on the steering wheel, or on the touch screen interface*.

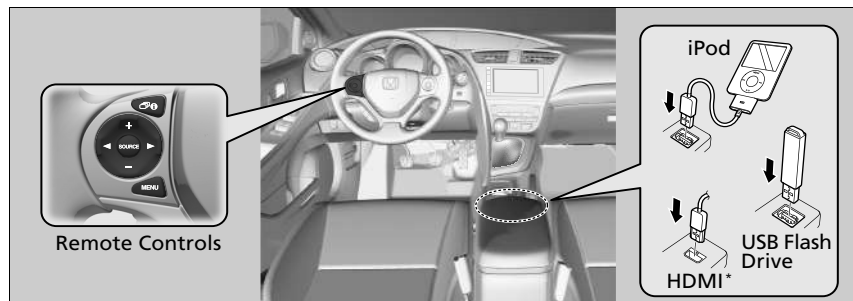

About Your Audio System

Video CDs, DVDs, and 8-cm (3-inch) mini CDs are not supported.

iPod, iPhone and iTunes are trademarks of Apple Inc.

Key Off Operation

You can use the audio system for 30 minutes when the ignition switch is in LOCK [0]*1 position, the system will then turn off automatically. However, whether you can continue using the audio system depends on the battery condition. Repeatedly using this feature may drain the battery.

Place your phone where you can get good reception.

*1: Models with the keyless access system have an **ENGINE START/STOP** button instead of an ignition switch.

USB Port(s)

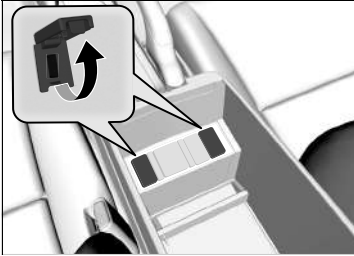

1. Open the cover.
2. Install the iPod dock connector or the USB flash drive to the USB port.

USB Port(s)

- Do not leave the iPod or USB flash drive in the vehicle. Direct sunlight and high temperatures may damage it.
- We recommend using an extension cable with the USB port.
- Do not connect the iPod or USB flash drive using a hub.
- Do not use a device such as a card reader or hard disk drive, as the device or your files may be damaged.
- We recommend keeping your data backed up before using the device in your vehicle.
- Displayed messages may vary depending on the device model and software version.

If the audio system does not recognise the iPod, try reconnecting it a few times or reboot the device. To reboot, follow the manufacturer's instructions provided with the iPod or visit www.apple.com/ipod.

HDMI™ Port*

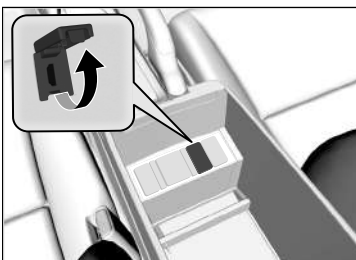

1. Open the cover.
2. Install the HDMI™ cable to the HDMI™ port.

⊗ HDMI™ Port*

- Do not leave the HDMI™ connected device in the vehicle. Direct sunlight and high temperatures may damage it.
- We recommend keeping your data backed up before using the device in your vehicle.
- Displayed messages may vary depending on the device model and software version.

The terms HDMI and HDMI High-Definition Multimedia Interface, and the HDMI Logo are trademarks or registered trademarks of HDMI Licensing LLC in the United States and other countries.

Auxiliary Input Jack*

Use the jack to connect a standard audio device.



1. Open the cover.
2. Connect a standard audio device to the input jack using a 3.5 mm (1/8 inch) stereo miniplug.
 - ▶ The audio system automatically switches to the AUX mode.

⊗ Auxiliary Input Jack*

To switch the mode, press any of the audio mode buttons. You can return to the AUX mode by pressing the **AUX*** or **CD/AUX*** button.

You cannot use the auxiliary input jack if you replace the audio system.

Audio System Theft Protection

The audio system is disabled when it is disconnected from the power source, such as when the battery is disconnected or goes dead. In certain conditions, the system may display **ENTER CODE***¹/**Enter Code***². If this occurs, reactivate the audio system.

■ Reactivating the audio system

1. Turn the ignition switch to ON ^{*3}.
2. Turn on the audio system.
3. Press and hold the audio system power button for more than two seconds.
 - ▶ The audio system is reactivated when the audio control unit establishes a connection with the vehicle control unit. If the control unit fails to recognise the audio unit, you must go to a dealer and have the audio unit checked.

*1: Models with one display

*2: Models with two displays

*3: Models with the keyless access system have an **ENGINE START/STOP** button instead of an ignition switch.

▶▶ Audio System Theft Protection

Models with one display

Find the audio system's security code and serial number label in your owner's manual kit.

We recommend that you write down the serial number in this owner's manual.

Do not store the label in your vehicle. If you lose the label, you must first retrieve the serial number, and then obtain the code.

You can find out about your serial number and security code from a dealer.

Audio Antenna*

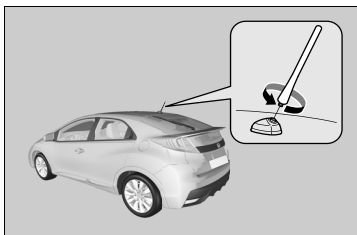

Your vehicle is equipped with a removable antenna at the rear of the roof.

▶▶ Audio Antenna*

NOTICE

Before using a “drive-through” car wash, remove the antenna by unscrewing it by hand. This prevents the antenna from being damaged by the car wash brushes.

Audio Remote Controls

Allow you to operate the audio system while driving.

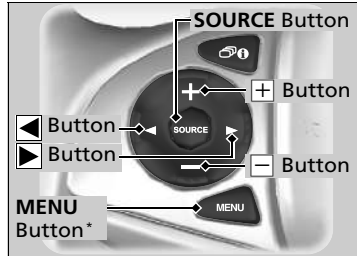

SOURCE Button

Cycles through the audio modes as follows:

Models with one display

FM1→FM2→DAB1*→DAB2*→LW→MW→
CD→AUX

Models with two displays

FM→LW→MW→DAB*→CD*→USB→iPod→
Apps→Bluetooth® Audio→AUX HDMI™

+ - (Volume) Buttons

Press +: To increase the volume.

Press -: To decrease the volume.

◀ ▶ Buttons

- When listening to the radio

Press ▶: To select the next preset radio station.

Press ◀: To select the previous preset radio station.

Press and hold ▶: To select the next strong station.

To select the next service (DAB).*

Press and hold ◀: To select the previous strong station.

To select the previous service (DAB).*

- When listening to a CD*, iPod, USB flash drive, or Bluetooth® Audio

Press ▶: To skip to the next song.

Press ◀: To go back to the beginning of the current or previous song.

- When listening to a CD (MP3/WMA/AAC)*, USB flash drive, or Bluetooth® Audio

Press and hold ▶: To skip to the next folder.

Press and hold ◀: To go back to the previous folder.

▶▶ Audio Remote Controls

Some mode appears only when an appropriate device or medium is used.

Depending on the Bluetooth® device you connect, some functions may not be operated.

* Not available on all models

Models with two displays

Steering Wheel **MENU** Button

- When listening to the radio
Press and hold the MENU button: To select the radio station by **Scan, Save Preset, or Seek.**
- When listening to a CD* or USB flash drive
Press and hold the MENU button: To select the song by **Scan, Repeat, Random, or Play/Pause***.
- When listening to an iPod
Press and hold the MENU button: To select the song by **Repeat** or **Shuffle.**
- When listening to a *Bluetooth*[®] Audio
Press and hold the MENU button: To select **Pause** or **Play** for the song.

▶▶ Audio Remote Controls

Models with two displays

The **MENU** button is available only when the audio mode is FM, AM, CD*, USB, iPod, or *Bluetooth*[®] Audio.

Audio System Basic Operation

Models with one display

To use the audio system, the ignition switch must be in ACCESSORY  or ON .

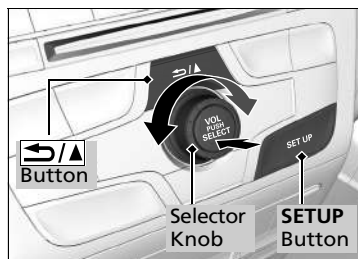

Use the selector knob or **SETUP** button to access some audio functions.

Press  to switch between the normal and extended display for some functions.

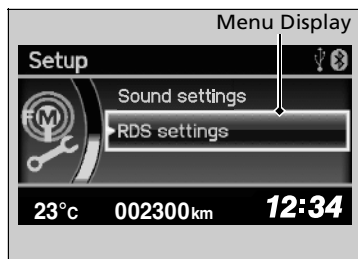

Selector knob: Rotate left or right to scroll through the available choices. Press  to set your selection.

SETUP button: Press to select any mode such as **Sound settings**, **RDS** (Radio Data System) **settings**, **DAB settings**^{*}, **Play mode**, **Resume/Pause**.





 **button:** Press to go back to the previous display.

Audio System Basic Operation

These indications are used to show how to operate the selector knob.

Rotate  to select.

Press  to enter.

Press the **SOURCE**, , ,  or  button on the steering wheel to change any audio setting.

 **Audio Remote Controls** P. 227

Setup Menu Items

 **Sound settings** P. 230

 **RDS settings** P. 235

 **DAB settings** P. 240



 **Play mode** P. 245, 249, 253

 **Resume/Pause** P. 256

* Not available on all models

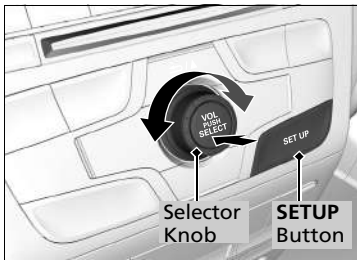
Adjusting the Sound



Press the **SETUP** button, and rotate  to select **Sound settings**, then press . Rotate  to scroll through the following choices:

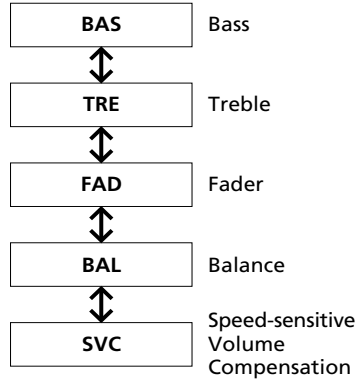
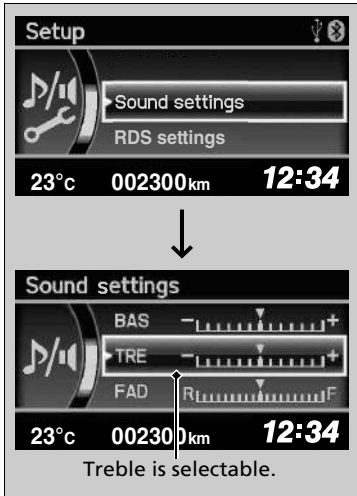

▶▶ Adjusting the Sound

The SVC has four modes: **Off**, **Low**, **Mid**, and **High**. SVC adjusts the volume level based on the vehicle speed. As you go faster, audio volume increases. As you slow down, audio volume decreases.

Playing AM/FM Radio

Models without DAB (Digital Audio Broadcasting)

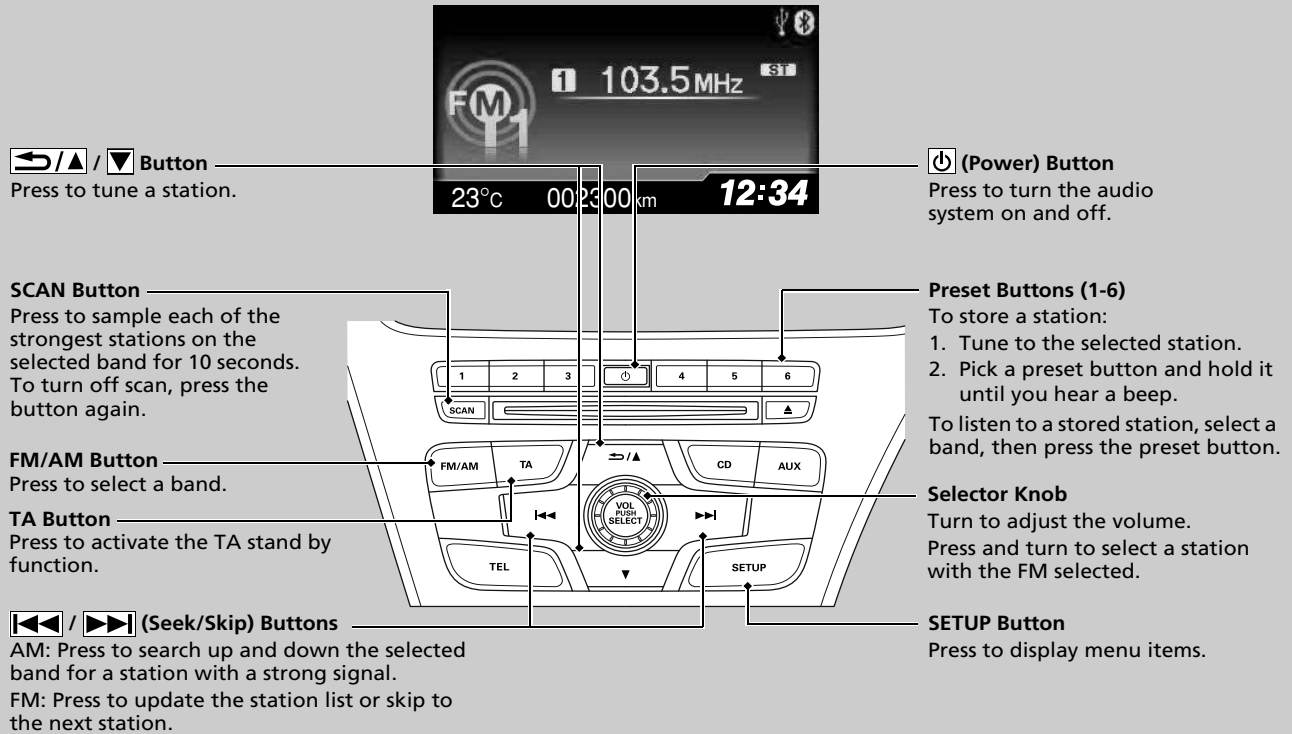

Models with DAB (Digital Audio Broadcasting)



Tune Button
Press to tune a station.

SCAN Button

Press to sample each of the strongest stations on the selected band for 10 seconds. To turn off scan, press the button again.

AM Button

FM/DAB Button
Press to select a band.



(Seek/Skip) Buttons

AM: Press to search up and down the selected band for a station with a strong signal.
FM: Press to update the station list or skip to the next station.



(Power) Button

Press to turn the audio system on and off.

TA Button

Press to activate the TA stand by function.

Preset Buttons (1-6)

To store a station:
1. Tune to the selected station.
2. Pick a preset button and hold it until you hear a beep.
To listen to a stored station, select a band, then press the preset button.

Selector Knob

Turn to adjust the volume.
Press and turn to select a station with the FM selected.

SETUP Button

Press to display menu items.

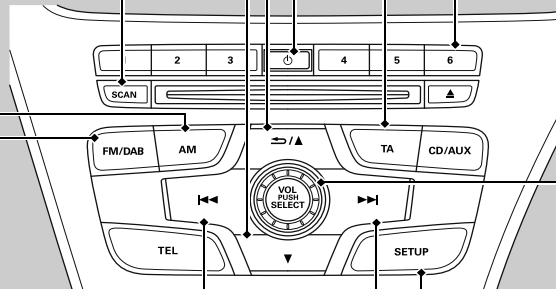

■ Radio Data System (RDS)

Provides convenient automated services related to your selected RDS-capable FM station.

▶▶ Playing AM/FM Radio

The **ST** indicator appears on the display indicating stereo FM broadcasts.

Stereo reproduction in AM is not available.

To switch the audio mode, press the **SOURCE** button on the steering wheel.

▶▶ **Audio Remote Controls** P. 227

You can store 12 AM stations and 12 FM stations into the preset button memory. AM has two types of frequencies LW and MW, and each lets you store six stations. FM1 and FM2 let you store six stations each.

▶▶ Radio Data System (RDS)

When you select an RDS capable FM station, the RDS automatically turns on, and the frequency display changes to the station name. However, when the signals of that station become weak, the display changes from the station name to the frequency.

Continued

■ To find an RDS station from Station List



1. Press while listening to an FM station.
2. Rotate to select the station, then press .

■ Manual Update

Updates your available station list at any time.

1. Press while listening to an FM station.
2. Rotate to select **Update list**, then press .

■ Available RDS functions

Alternative Frequency (AF):

Automatically changes the frequency of the same programme as you enter different regions.

Regional Programme (REG):

Keeps the same frequency of the stations within that region even if the signal gets weak.

News Programme (NEWS):

Automatically tunes to the news programme.

▶▶ Radio Data System (RDS)

While listening to an FM station on **Station list**, pressing (Seek/Skip) button changes the station.

If the system cannot find any station on **Station list**, a confirmation message for updating the list appears. Rotate to select **Yes**, then press to update the list.

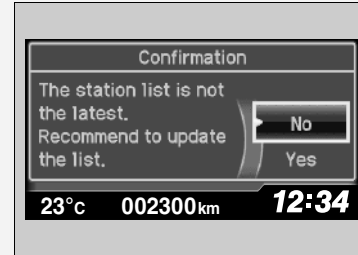

■ Selecting the RDS functions

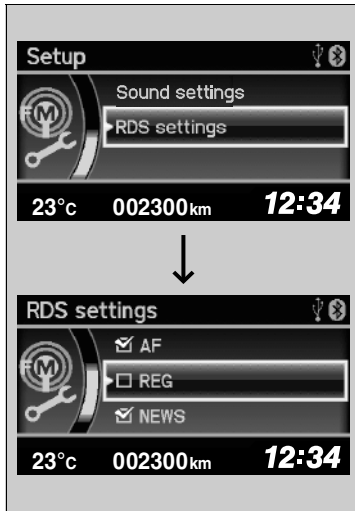

1. Press the **SETUP** button with the FM selected.
2. Rotate to select **RDS settings** and press .
3. Each RDS function is displayed every time you rotate .
4. Press to select a function.

▣ Radio Data System (RDS)

Turning the Alternative Frequency (AF) function on and off turns the RDS on and off.

Pressing switches the function between on and off.

Continued

■ Traffic announcement (TA) button

TA standby function allows the system to stand by for traffic announcements in any mode. The last tuned station must be an RDS-capable traffic programme station.

To turn the function on: Press the **TA** button. When a traffic announcement begins on your last tuned station, the system automatically switches to the FM mode. TA-INFO appears on the display. The system returns to your last selected mode after the traffic announcement is finished.

If you want to go back to your last selected mode during the traffic announcement, press the **TA** button again.

To cancel the function: Press the **TA** button.

☒ Radio Data System (RDS)

TA

When you press the **TA** button, the **TA** indicator appears on the display.

If you press the **SCAN** button while the TA standby function is on, the system searches TP station only.

Pressing the **TA** button while the traffic announcement is on does not cancel the TA standby function.

■ Programme type (PTY)/News interrupt function

Allows the system to interrupt with a newscast in any mode. The last tuned station must be the NEWS PTY coded station.

To activate the function: Select **NEWS** from **RDS settings** and display the NEWS PTY before changing to other modes. When a newscast begins on your last tuned station, the system automatically switches to the FM mode.

📄 **Selecting the RDS functions** P. 235

The system returns to your last selected mode if changed to another programme, or signal gets weak.

■ PTY alarm

The PTY code, ALARM is used for emergency announcements, such as natural disasters. When this code is received, ALARM appears on the display and the system interrupts your audio operation.

Playing DAB (Digital Audio Broadcasting)*

↶/▲ / ▼ Button

- Press to tune a DAB ensemble.
- Press and hold to search up and down top station in the DAB ensemble with a strong signal. The top station within this ensemble is selected.

SCAN Button

Press to sample each of the strongest stations on the station list for 10 seconds. To turn off scan, press the button again.

FM/DAB Button

Press to select a band.

⏮ / ⏭ (Seek/Skip) Buttons

Press to skip the station on the station list.



The DAB indicator appears on the display when the DAB band is selected.

⏻ (Power) Button

Press to turn the audio system on and off.

Preset Buttons (1-6)

To store a station:

1. Tune to the selected station.
2. Pick a preset button and hold it until you hear a beep.

To listen to a stored station, select a band, then press the preset button.

Selector Knob

Turn to adjust the volume.

Press and turn to select a station on the station list or ensemble.

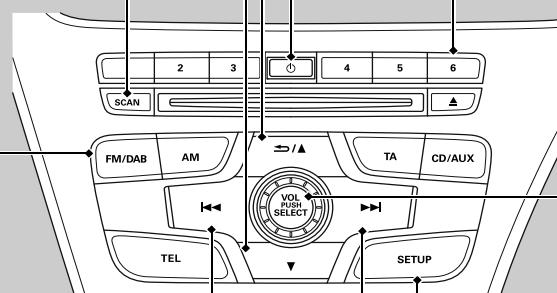

SETUP Button

Press to display menu items.





To find an DAB station from Service List or Ensemble List



1. Press  while selecting the DAB mode.
2. Rotate  to select the station, then press .
 - ▶ If you select **Update list**, the system update the station list.

▶▶ To find an DAB station from Service List or Ensemble List

If the system cannot find a station, a confirmation message for updating the list appears. Rotate  to select **Yes**, then press  to update the list.

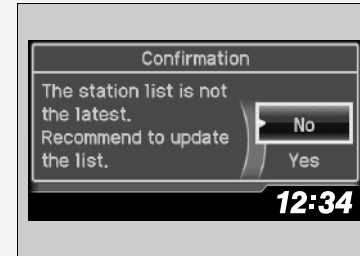

Continued

■ Setting the DAB functions

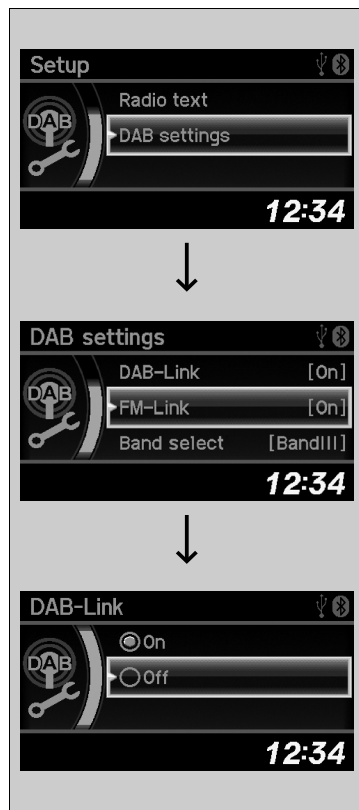

1. Press the **SETUP** button with the DAB selected.
2. Rotate to select **DAB settings** and press .

3. Each DAB function is displayed every time you rotate .
4. Press to select a function.

5. Rotate to select a setting, then press .

■ DAB Settings

■ DAB-Link:

Automatically searches for the same station from Ensembles, and switches to it.

■ FM-Link:



If the system finds the same station from an FM band, it automatically switches the band.

■ Band select:

You can select specific bands. This can reduce the time to update the lists, and search for a station.

■ Radio Text



1. Press the **SETUP** button with the DAB selected.
2. Rotate  to select **Radio text** and press .

☒ Radio Text

The **TEXT** indicator appears on the display indicating radio text information.

Playing a CD

Your audio system supports audio CDs, CD-Rs and CD-RWs in either MP3 or WMA format. With the CD loaded, press the **CD*** or **CD/AUX*** button.

Models without DAB (Digital Audio Broadcasting)

SCAN Button

You will get a 10-second sampling of each song.

- Press to sample all tracks on the CD (all files in the current folder in MP3 or WMA).
- Press twice to sample the first file in each of the main folders (MP3 or WMA).
- To turn off scan, press and hold the button.

Navigation Buttons

Press **↶/▲** to skip to the next folder, and **▼** to skip to the beginning of the previous folder in MP3 or WMA.

Seek/Skip Buttons

Press to change tracks (files in MP3 or WMA).



(Power) Button

Press to turn the audio system on and off.

CD Slot

Insert a CD about halfway into the CD slot.

CD Button

Press to play a CD.

(CD Eject) Button

Press to eject a CD.

Selector Knob

Turn to adjust the volume. Press and turn to select an item, then press to set your selection.

SETUP Button

Press to display menu items.

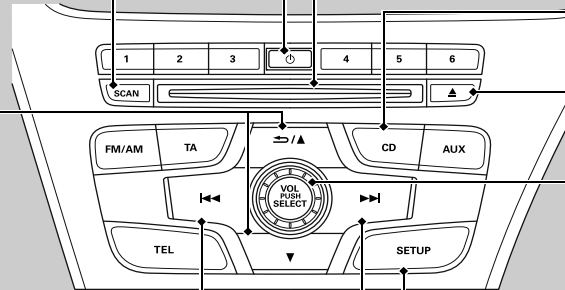

Models with DAB (Digital Audio Broadcasting)

SCAN Button

You will get a 10-second sampling of each song.

- Press to sample all tracks on the CD (all files in the current folder in MP3 or WMA).
- Press twice to sample the first file in each of the main folders (MP3 or WMA).
- To turn off scan, press and hold the button.

↔/▲/▼ Button

Press ↔/▲ to skip to the next folder, and ▼ to skip to the beginning of the previous folder in MP3 or WMA.

◀◀ / ▶▶ (Seek/Skip) Buttons

Press to change tracks (files in MP3 or WMA).



⏻ (Power) Button

Press to turn the audio system on and off.

CD Slot

Insert a CD about halfway into the CD slot.

▲ (CD Eject) Button

Press to eject a CD.

CD/AUX Button

Press to play a CD.

Selector Knob

Turn to adjust the volume. Press and turn to select an item, then press to set your selection.

SETUP Button

Press to display menu items.

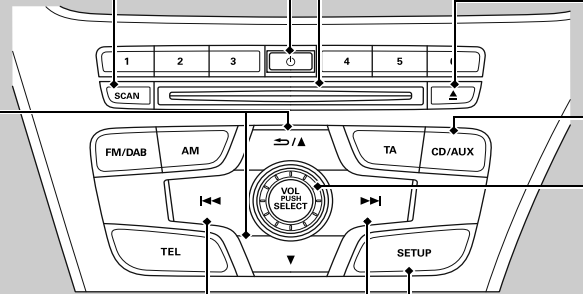

How to Select a File from a Folder with the Selector Knob (MP3/WMA)

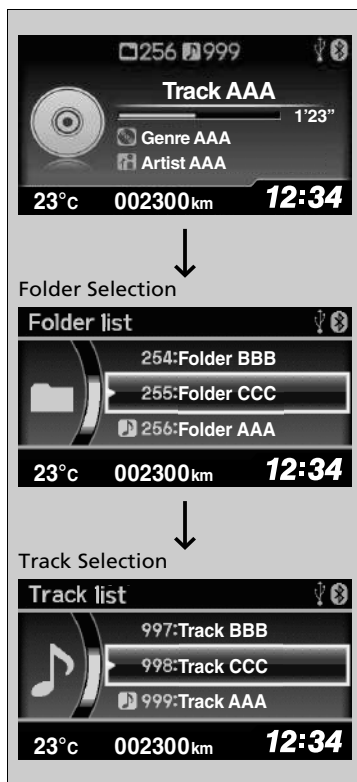

1. Press to switch the display to a folder list.

2. Rotate to select a folder.

3. Press to change the display to a list of files in that folder.

4. Rotate to select a file, then press .

▶▶ Playing a CD

NOTICE

Do not use CDs with adhesive labels. The label can cause the CD to jam in the unit.

WMA files protected by digital rights management (DRM) cannot be played.

The audio system displays **Unsupported**, then skips to the next file.

Text data appears on the display under the following circumstances:

- When you select a new folder, file, or track.
- When you change the audio mode to CD.
- When you insert a CD.

If you eject the CD but do not remove it from the slot, the system reloads the CD automatically after several seconds.

■ How to Select a Play Mode

You can select repeat and random modes when playing a track or file.

1. Press the **SETUP** button.

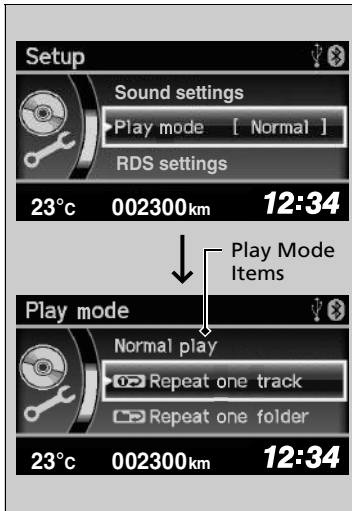

2. Rotate to select **Play mode**, then press .

3. Rotate to select a mode, then press .

■ To turn off a play mode

1. Press the **SETUP** button.

2. Rotate to select **Play mode**, then press .

3. Rotate to select **Normal play**, then press .

▶▶ How to Select a Play Mode

Press the button to go back to the previous display, and press the **SETUP** button to cancel this setting mode.

Play mode menu items

Normal play

Repeat one track: Repeats the current track/file.

Repeat one folder (MP3/WMA): Repeats all files in the current folder.

Random in folder (MP3/WMA): Plays all files in the current folder in random order.

Playing an iPod

Connect the iPod using your dock connector to the USB port, then press the **AUX*** or **CD/AUX*** button.

➤ **USB Port(s)** P. 223

Models without DAB (Digital Audio Broadcasting)

Album Art



USB Indicator

Appears when an iPod is connected.

Button

Press to go back to the previous display.

Press to set your selection.

(Power) Button

Press to turn the audio system on and off.

AUX Button

Press to select iPod (if connected).

Selector Knob

Turn to adjust the volume.

Press and turn to select an item, then press to set your selection.

(Seek/Skip) Buttons

Press to change songs.

SETUP Button

Press to display menu items.



Models with DAB (Digital Audio Broadcasting)

Album Art



USB Indicator
Appears when an iPod is connected.

 **Button**

Press  to go back to the previous display.
Press  to set your selection.

 **(Power) Button**
Press to turn the audio system on and off.

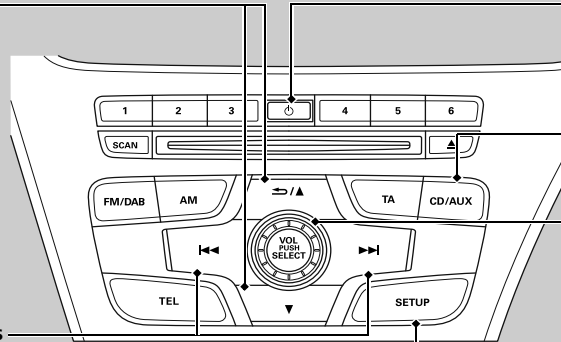

CD/AUX Button
Press to select iPod (if connected).

Selector Knob
Turn to adjust the volume.
Press and turn to select an item, then press to set your selection.

 **(Seek/Skip) Buttons**
Press to change songs.

SETUP Button
Press to display menu items.

How to Select a File from the iPod Menu

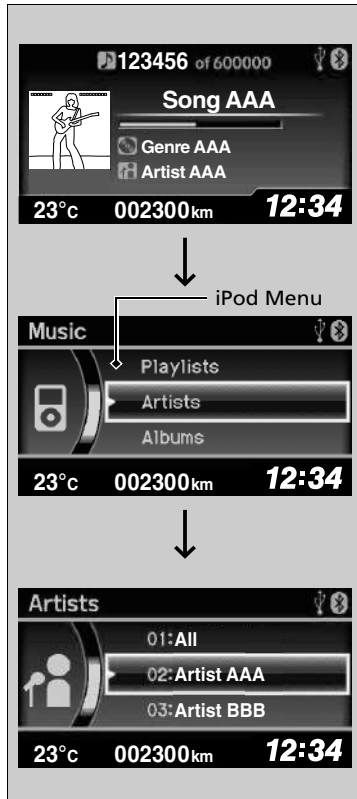

1. Press to display the iPod menu.

2. Rotate to select a menu.

3. Press to display the items on that menu.

4. Rotate to select an item, then press .

▶▶ Playing an iPod

Available operating functions vary on models or versions. Some functions may not be available on the vehicle's audio system.

If there is a problem, you may see an error message on the i-multi-information display.

iPod/USB Flash Drive P. 305

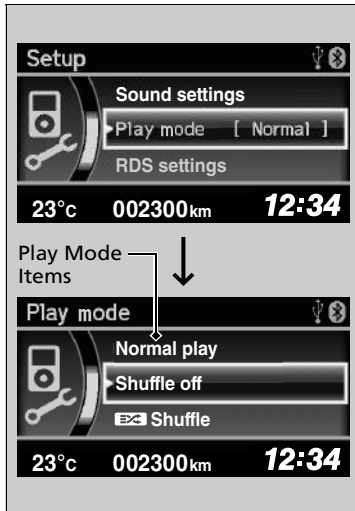

How to Select a Play Mode

You can select repeat and shuffle modes when playing a file.



1. Press the **SETUP** button.

2. Rotate  to select **Play mode**, then press .

3. Rotate  to select a mode, then press .

To turn off a play mode

1. Press the **SETUP** button.

2. Rotate  to select **Play mode**, then press .

3. Rotate  to select **Normal play**, then press .

How to Select a Play Mode

Play mode menu items

Normal play

Shuffle off: Turns off the shuffle mode.

Shuffle: Plays all available files in a selected list (playlists, artists, albums, songs, genres, or composers) in random order.

Shuffle albums: Plays all available albums in a selected list (playlists, artists, albums, songs, genres, or composers) in random order.

Repeat off: Turns off the repeat mode.

Repeat one track: Repeats the current track.

Playing a USB Flash Drive

Your audio system reads and plays sound files on a USB flash drive in either MP3, WMA or AAC*1 format.

Connect your USB flash drive to the USB port, then press the **AUX*** or **CD/AUX*** button.

➔ **USB Port(s)** P. 223

Models without DAB (Digital Audio Broadcasting)

⏪ / ⏩ / ⏴ Button

Press **⏪ / ⏩** to skip to the next folder, and **⏴** to skip to the beginning of the previous folder.

SCAN Button

You will get a 10-second sampling of each file.

- Press to sample all files in the current folder.
- Press twice to sample the first file in each of the main folders.
- To turn off scan, press and hold the button.

⏮ / ⏭ (Seek/Skip) Buttons

Press to change files.



USB Indicator

Appears when a USB flash drive is connected.

⏻ (Power) Button

Press to turn the audio system on and off.

AUX Button

Press to select USB flash drive (if connected).

Selector Knob

Turn to adjust the volume. Press and turn to select an item, then press to set your selection.

SETUP Button

Press to display menu items.

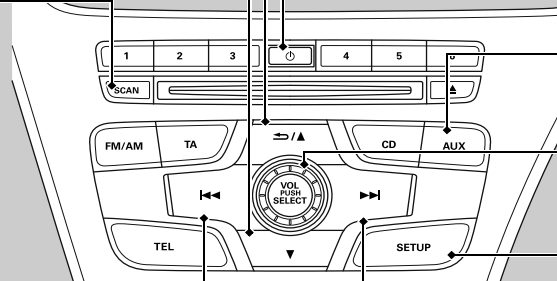

*1: Only AAC format files recorded with iTunes are playable on this unit.

Models with DAB (Digital Audio Broadcasting)



USB Indicator
Appears when a USB flash drive is connected.

↵/▲/▼ Button

Press **↵/▲** to skip to the next folder, and **▼** to skip to the beginning of the previous folder.

SCAN Button

You will get a 10-second sampling of each file.

- Press to sample all files in the current folder.
- Press twice to sample the first file in each of the main folders.
- To turn off scan, press and hold the button.

⏮ / ⏭ (Seek/Skip) Buttons

Press to change files.

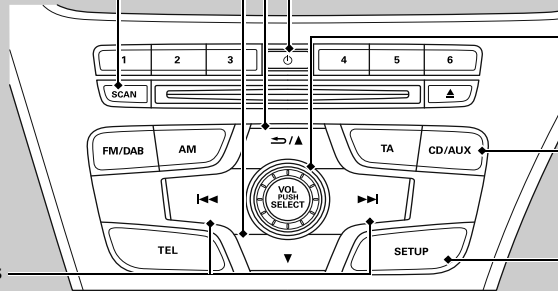

⏻ (Power) Button
Press to turn the audio system on and off.

Selector Knob
Turn to adjust the volume. Press and turn to select an item, then press to set your selection.

CD/AUX Button
Press to select USB flash drive (if connected).

SETUP Button
Press to display menu items.

How to Select a File from a Folder with the Selector Knob

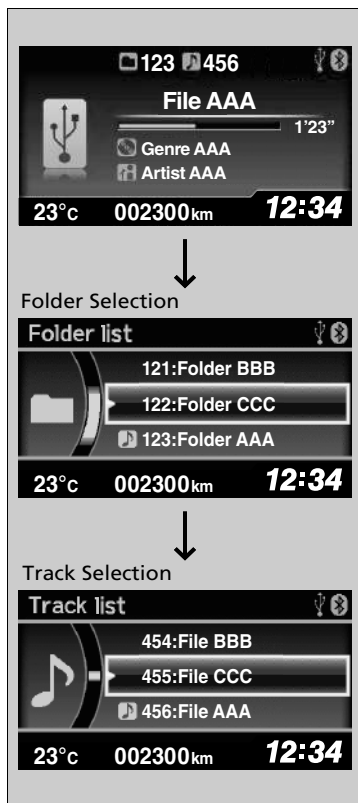

1. Press to switch the display to a folder list.

2. Rotate to select a folder.

3. Press to change the display to a list of files in that folder.

4. Rotate to select a file, then press .

▶▶ Playing a USB Flash Drive

Use the recommended USB flash drives.

General Information on the Audio System
P. 308

WMA files protected by digital rights management (DRM) cannot be played.

The audio system displays **Unplayable file**, then skips to the next file.

If there is a problem, you may see an error message on the i-multi-information display.

iPod/USB Flash Drive P. 305

How to Select a Play Mode

You can select repeat and random modes when playing a file(s).



1. Press the **SETUP** button.

2. Rotate to select **Play mode**, then press .

3. Rotate to select a mode, then press .

To turn off a play mode

1. Press the **SETUP** button.

2. Rotate to select **Play mode**, then press .

3. Rotate to select **Normal play**, then press .

How to Select a Play Mode

Play mode menu items

Normal play

Repeat one track: Repeats the current file.

Repeat one folder: Repeats all files in the current folder.

Random in folder: Plays all files in the current folder in random order.

Random all: Plays all files in random order.

Playing *Bluetooth*® Audio

Your audio system allows you to listen to music from your *Bluetooth*-compatible phone.

This function is available when the phone is paired and connected to the vehicle's Hands-Free Telephone (HFT) system.

➔ **Phone Setup** P. 335

Models without DAB (Digital Audio Broadcasting)

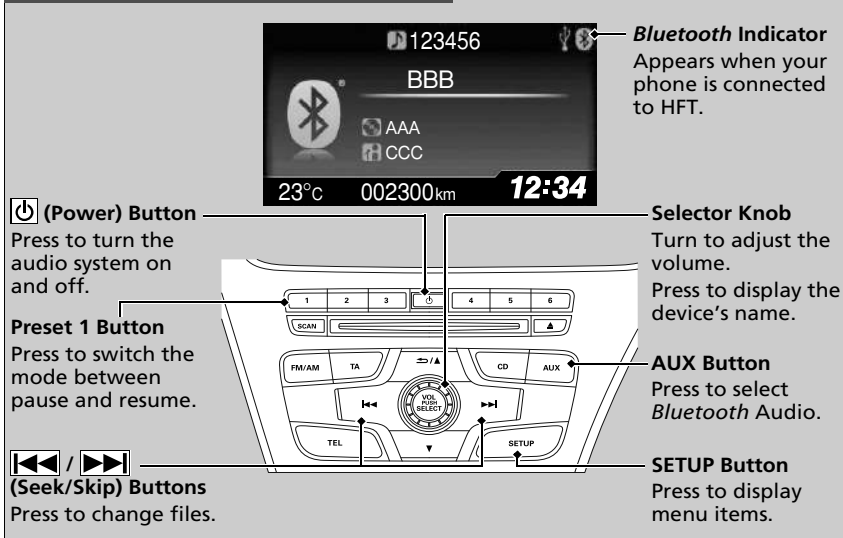

▶▶ Playing *Bluetooth*® Audio

Not all *Bluetooth*-enabled phones with streaming audio capabilities are compatible with the system.

You can find an approved phone by visiting:

- Europe:
<http://www.hondahandsfree.com/>.
- Middle East:
<http://www.globalhondahandsfree.com/>.

In some countries, it may be illegal to perform some data device functions while driving.

If more than one phone is paired to the HFT system, there will be a delay before the system begins to play.

In some cases, the name of the artist, album, or track may not appear correctly.

Some functions may not be available on some devices.

Models with DAB (Digital Audio Broadcasting)

The diagram shows a car's audio system interface. At the top is a display screen showing a Bluetooth connection status with a signal strength indicator, the name 'BBB', and a frequency '123456'. Below the screen are several control buttons: a power button, a row of six preset buttons (1-6), a selector knob, a CD/AUX button, a central volume knob, and buttons for FM/DAB, AM, TA, TEL, and SETUP. Arrows point from text labels to these specific controls.

Bluetooth Indicator
Appears when your phone is connected to HFT.

(Power) Button
Press to turn the audio system on and off.

Preset 1 Button
Press to switch the mode between pause and resume.

(Seek/Skip) Buttons
Press to change files.

Selector Knob
Turn to adjust the volume.
Press to display the device's name.

CD/AUX Button
Press to select *Bluetooth* Audio.

SETUP Button
Press to display menu items.

■ To Play *Bluetooth*® Audio Files

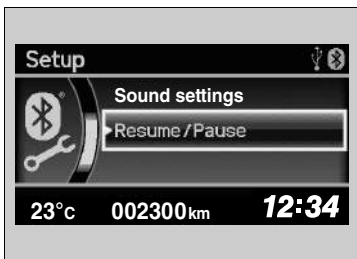

1. Make sure that your phone is paired and connected to HFT.
2. Press the **AUX*** or **CD/AUX*** button.

If the phone is not recognised, another HFT-compatible phone, which is not compatible for *Bluetooth*® Audio, may already be connected.

■ To pause or resume a file

1. Press the **SETUP** button.
2. Rotate to select **Resume/Pause**, then press .

Each time you press , the setting switches between pause and resume.

■ Switching to HFT

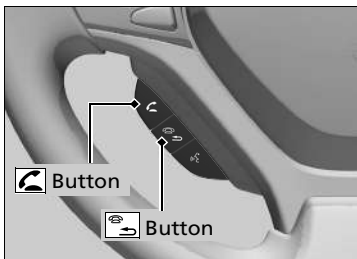

Press the (pick-up) button on the steering wheel to receive a call when *Bluetooth*® Audio is playing.

▶ **Hands-Free Telephone System*** P. 329

Press the (hang-up/back) button to end the call and return to *Bluetooth*® Audio.

▶▶ To Play *Bluetooth*® Audio Files

To play the audio files, you may need to operate your phone. If so, follow the phone maker's operating instructions.

The pause function may not be available on some phones.

If any audio device is connected to the auxiliary input jack, you may need to press the **AUX*** or **CD/AUX*** button repeatedly to select the *Bluetooth*® Audio system.

Switching to another mode pauses the music playing from your phone.

▶▶ Switching to HFT

If you receive a call while *Bluetooth*® Audio is in the pause mode, it resumes play after ending the call.

Audio System Basic Operation

Models with two displays

You can use the audio system for 30 minutes when the ignition switch is in LOCK [0]*¹ position, the system will then turn off automatically.

If you want to keep using it, we recommend that you turn the ignition switch to ACCESSORY [I] or ON [II]*¹.

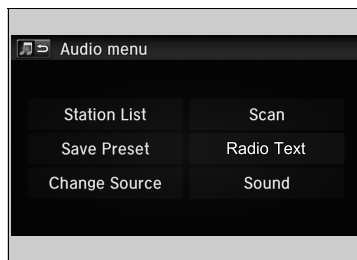
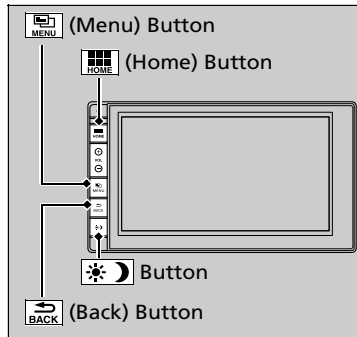

 (Home) Button: Press to go to the home screen.



 **Switching the Display** P. 259

 (Menu) Button: Press to select any mode. The available mode includes **Change Source**, **Station List**, **Save Preset**, **Radio Text**, **Music Search**, and play modes. Play modes can be also selected from **Scan**, **Random/Repeat**, and so on.

 (Back) Button: Press to go back to the previous display when it is displayed.

 **button:**

Press to change the audio/information screen brightness.

Press  once and select  or  to make an adjustment.

▶ Each time you press , the mode switches among the daytime mode, nighttime mode and off mode.

* 1: Models with the keyless access system have an **ENGINE START/STOP** button instead of an ignition switch.

Audio System Basic Operation

Audio Menu Items

 **Station List** P. 278

 **How to Select a File from the Music Search List (MP3/WMA/AAC)** P. 285, 291

 **Scan** P. 282

 **How to Select a Play Mode** P. 286, 289, 292

When the battery has been reconnected or replaced, the next start-up may take a few minutes for the audio system to start. Wait a few moments while the system is starting up.

Press and hold the  (power) button for approximately 10 seconds to reset the system. When the system is reset and started up, you are required to input the password.

 **Audio System Theft Protection** P. 225

Key Off Operation

 **Key Off Operation** P. 222

Continued

Models with navigation system

■ How to access the disc slot

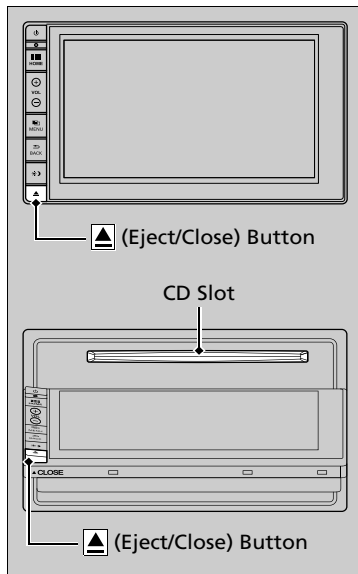

Press the  (Eject/Close) button to open the screen.

- ▶ The screen folds back, and the CD slot appears.

Press the  (Eject/Close) button to return the screen to the upright position.

▶▶ How to access the disc slot

If you eject the CD but do not remove it from the slot, the system reloads the CD automatically after several seconds.

Do not use the folded down screen as a tray.

Audio/Information Screen

Displays the audio status and wallpaper. From this display, you can go to various setup options.

Switching the Display

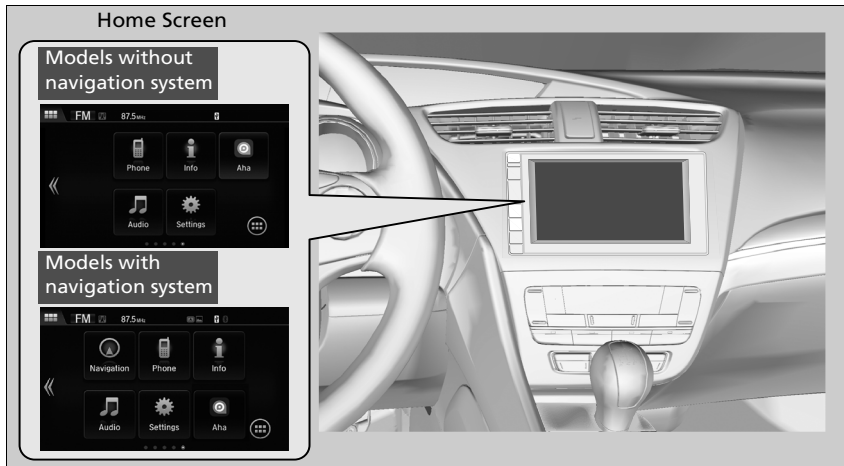

Press the  button to go to the home screen.
Select **Phone**, **Info**, **Audio**, **Settings**, or **Navigation***.

Phone

Displays the HFT information.

 **Hands-Free Telephone System** P. 353

* Not available on all models

Continued

■ Info

To see all available information, **Trip Computer**, **Clock/Wallpaper**, or **System/Device Information**, press the  button.

Trip Computer:

- **Current Drive** tab: Displays the current trip information.
- **History of Trip A** tab: Displays information for the three previous drives. The information is stored every time you reset Trip A.

Clock/Wallpaper:

Displays the clock and wallpaper.

System/Device Information:

- **Version Information:** Displays the software version of the audio system.
- **USB Device Information:** Displays the memory usage of the USB device.
- **USB Device Change:** Connects or disconnects USB device to this audio system.

■ Audio

Displays the current status.

■ Settings

Enters the customizing menu screen.

➤ **Customized Features** P. 313

■ Navigation*

Displays the navigation screen.

➤ **Refer to the Navigation System Manual**

■ Changing the Home Screen Icon Layout

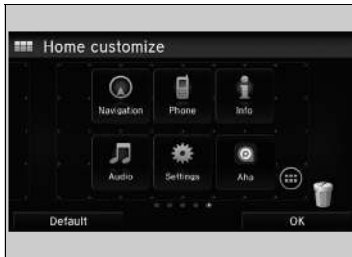

1. Press the  button.
2. Select **Settings**.
3. Select **System**.
4. Select the **HOME** tab.
5. Select **Home icon position**.
6. Select and hold the icon then, drag it to the desired position.

Wallpaper Setup

You can change, store, and delete the wallpaper on the audio/information screen.

Import wallpaper

You can import up to five images, one at a time, for wallpaper from a USB flash drive.

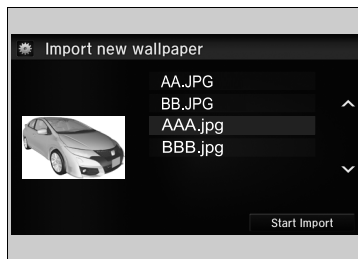
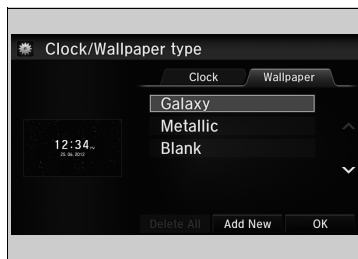

1. Connect the USB flash drive to the USB port.

▶ **USB Port(s)** P. 223

2. Select **Settings**.
3. Select **Info**.
4. Select **Clock/Wallpaper Type**, then open the **Wallpaper** tab.
5. Select **Add New**.
 - ▶ The picture name is displayed on the list.
6. Select a desired picture.
 - ▶ The preview is displayed on the left side on the screen.
7. Select **Start Import** to save the data.
 - ▶ The display will return to the wallpaper list.

Wallpaper Setup

The wallpaper you set up on **Clock Wallpaper/Type** cannot be displayed on the i-multi information display.

- When importing wallpaper files, the image must be in the USB flash drive's root directory. Images in a folder cannot be imported.
- The file name must be fewer than 64 characters.
- The file format of the image that can be imported is BMP (bmp) or JPEG (jpg).
- The individual file size limit is 5 MB.
- The maximum image size is 4,096 × 4,096 pixels. If the image size is less than 800 × 480 pixels, the image is displayed in the middle of the screen with the extra area appearing in black.
- If the USB flash drive does not have any pictures, the **No files detected** message appears.

■ Select wallpaper

1. Select **Settings**.
2. Select **Info**.
3. Select **Clock/Wallpaper Type**, then open the **Wallpaper** tab.
 - ▶ The screen changes to the wallpaper list.
4. Select a desired wallpaper.
 - ▶ The preview is displayed on the left side on the screen.
 - ▶ The pop-up menu appears on the screen.
5. Select **Set**.
 - ▶ The display will return to the wallpaper list.

■ Delete wallpaper

1. Select **Settings**.
2. Select **Info**.
3. Select **Clock/Wallpaper Type**, then open the **Wallpaper** tab.
 - ▶ The screen changes to the wallpaper list.
4. Select a wallpaper that you want to delete.
 - ▶ The preview is displayed on the left side on the screen.
 - ▶ The pop-up menu appears on the screen.
5. Select **Delete**.
 - ▶ A confirmation message appears on the screen.
6. Select **Yes** to delete completely.
 - ▶ The display will return to the wallpaper list.

Wallpaper Setup

From the pop-up menu, select **Preview** to see a preview at full-size screen.

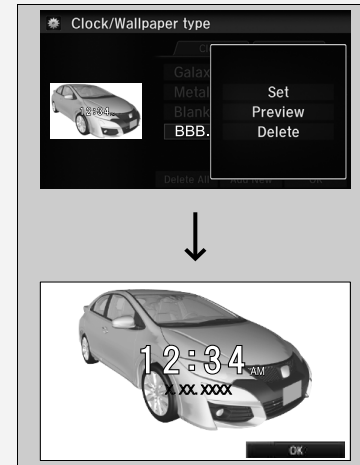

To go back to the previous screen, select **OK**, or press the  (Back) button.



When the file size is large, it takes a while to be previewed.

To delete all wallpapers you add, select **Delete All**, then **Yes**.

Home Screen

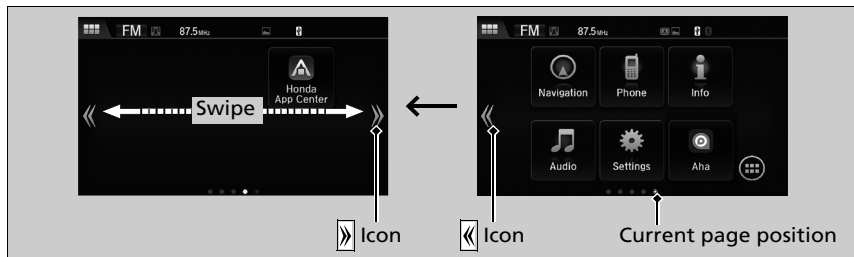
■ To change to a next screen



Selecting  or , or swiping the screen left or right changes to the next screen.

Home Screen

The home screen has 5 pages (fixed). You cannot add any more pages.

■ To use apps or widgets

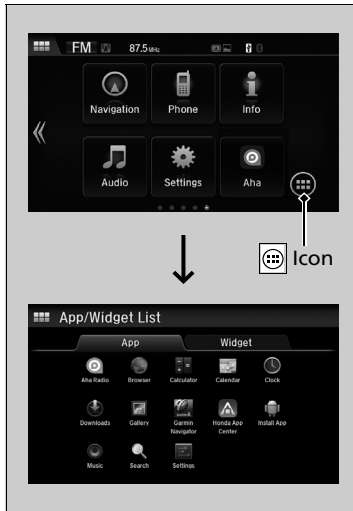

1. Select .
 - ▶ The **App/Widget List** screen appears.
2. Select the app or widget you want to use.

Preinstall app list:

- **Aha Radio:** Starts up Aha Radio app.
- **Browser:** Displays the web browser utilized by smartphone and Wi-Fi connection.
- **Calculator:** Displays Calculator.
- **Calendar:** Displays Calendar.
- **Clock:** Displays Clock.
- **Downloads:** Displays the data downloaded from the web browser and so on.
- **Gallery:** Displays the image list stored in the audio system.
- **Garmin Navigator:** Starts up navigation app.
- **Honda App Center:** Displays Honda App Center.
- **Install App:** Installs and updates app stored in the USB flash drive. However, you can install and update app only through Honda App Center.
- **Music:** Displays the music list stored in the audio system.
- **Search:** Displays various retrieval screens.
- **Settings:** Displays the Android setting screen.

▶▶ To use apps or widgets

Select and hold a selected app or widget to add that app's or widget's shortcut on the home screen.

If preinstall apps do not startup normally, try **Factory Data Reset**. In case those apps still do not startup normally even after **Factory Data Reset**, contact your dealer.

If you perform **Factory Data Reset**, it may reset all the settings to their factory default.

▶ **Defaulting All the Settings** P. 328

Continued

■ To add app or widget icons on the home screen

App or widget icons can be added on the home screen.

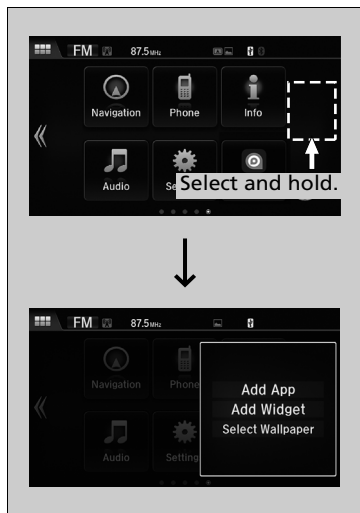

1. Select and hold empty space on the home screen.
 - ▶ The pop-up menu appears on the screen.
2. Select **Add App** or **Add Widget**.
 - ▶ The **Add App/Widget** screen appears.

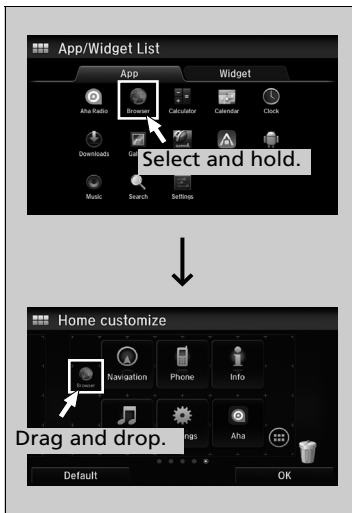

3. Select and hold an app or widget icon you want to add.
 - ▶ The screen switches to the **Home customize** screen.
4. Drag and drop the icon to where you want it to be.
5. Select **OK**.
 - ▶ The screen will return to the home screen.

■ To move icons on the home screen

You can change location on the home screen.

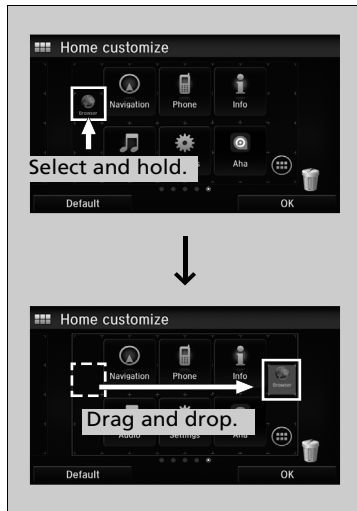

1. Select and hold an icon.
 - ▶ The screen switches to the **Home customize** screen.
2. Drag and drop the icon to where you want it to be.
3. Select **OK**.
 - ▶ The screen will return to the home screen.

☒ To move icons on the home screen

You can also move the **Phone, Info, Audio, Settings,** and **Navigation*** icons in the same manner.

■ To delete icons on the home screen

You can delete the icons on the home screen.

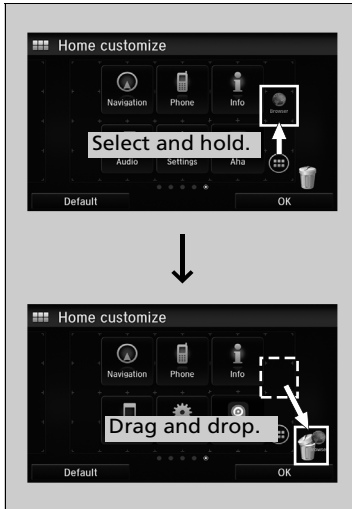

1. Select and hold an icon.
 - ▶ The screen switches to the **Home customize** screen.
2. Drag and drop the icon you want to delete to waste basket icon.
 - ▶ The icon is deleted.
3. Select **OK**.
 - ▶ The screen will return to the home screen.

☒ To delete icons on the home screen

You cannot delete the **Phone**, **Info**, **Audio**, **Settings**, and **Navigation*** icons.

Apps or widgets will not be deleted by deleting the icon on the home screen.

* Not available on all models

Continued

■ To change a wallpaper of the home screen

You can change a wallpaper of the home screen.

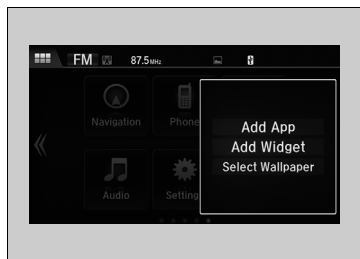

1. Select and hold empty space on the home screen.
 - ▶ The pop-up menu appears on the screen.
2. Select **Select Wallpaper**.
 - ▶ The pop-up menu appears on the screen.





3. Select an app for selecting wallpapers.
4. Select the wallpaper you want to change.
5. Select **Set wallpaper**.
 - ▶ The wallpaper is changed, then the screen will return to the home screen.

Status Area



Swipe the upper area of the screen.
▶ The status area appears.

Select an item to see the details.

Select  or swipe up the  icon to close the area.

Changing the Screen Interface

You can change the screen interface design.

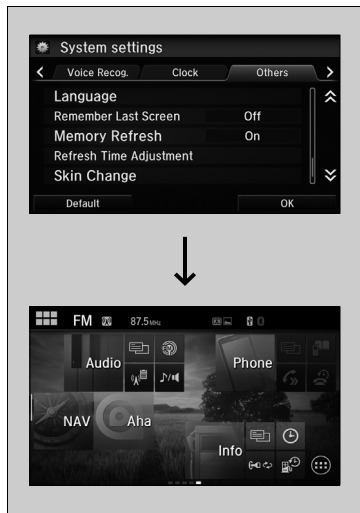

1. Press the  button.
2. Select **Settings**.
3. Select **System**.
4. Select the **Others** tab.
5. Select **Skin Change**.
6. A confirmation message appears on the screen. Select **Yes**.

Changing the Screen Interface

You need to reboot the system after changing the interface design. Wait a few moments while the system is starting up.

You can change the wallpaper on the audio/ information screen.

➤ **Wallpaper Setup** P. 262

If you change the screen interface, some of the setting items will change.

➤ **Customized Features** P. 313

■ Closing Apps

You can close apps running in the background on the system.



1. Press and hold the  button.
2. Select the **Active** tab.
 - ▶ If you select the **Active/History** tab, you can close the apps that are currently running and delete the app activity history simultaneously.
3. Select an app you want to close.
4. Select **Clear**.
 - ▶ The display will return to the app list.

☒ Closing Apps

If you leave the apps used open in the background, some apps may stop operating properly next time using them.

If this happens close unused apps.

To close all apps on the system, select **Clear All**, then **Yes**.

Adjusting the Sound

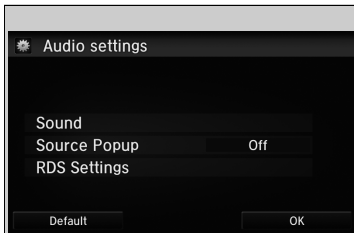

1. Press the  button.
2. Select **Settings**.
3. Select **Audio**.
4. Select **Sound**.

Select a tab from the following choices:
**BASS, TREBLE, FADER, BALANCE, Speed
Volume Compensation (SVC)**

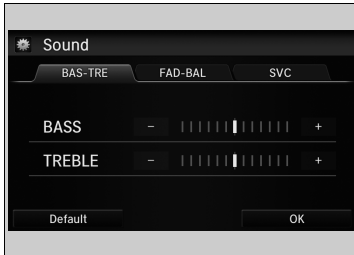

▶▶ Adjusting the Sound

The SVC has four modes: **Off, Low, Mid, and High**. SVC adjusts the volume level based on the vehicle speed. As you go faster, audio volume increases. As you slow down, audio volume decreases.

Display Setup

You can change the brightness or colour theme of the audio/information screen.

Changing the Screen Brightness

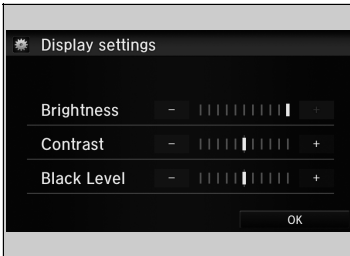

1. Press the  button.
2. Select **Settings**.
3. Select **System**.
4. Select the **Display** tab.
5. Select **Display Settings**.
6. Select the setting you want.
7. Select **OK**.

Changing the Screen's Colour Theme

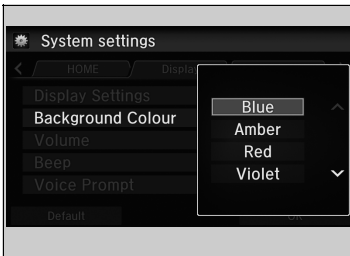

1. Press the  button.
2. Select **Settings**.
3. Select **System**.
4. Select the **Display** tab.
5. Select **Background Colour**.
6. Select the setting you want and select it again.
 - ▶ A confirmation message appears on the screen. Select **Yes** to reboot the system.

Changing the Screen Brightness

You can change the **Contrast** and **Black Level** settings in the same manner.

Changing the Screen's Colour Theme

Reboot may take a few minutes. If you default the **system** settings when the colour theme is changed from its default colour, the system reboots.

▶ **Customized Features** P. 313

■ Selecting an Audio Source

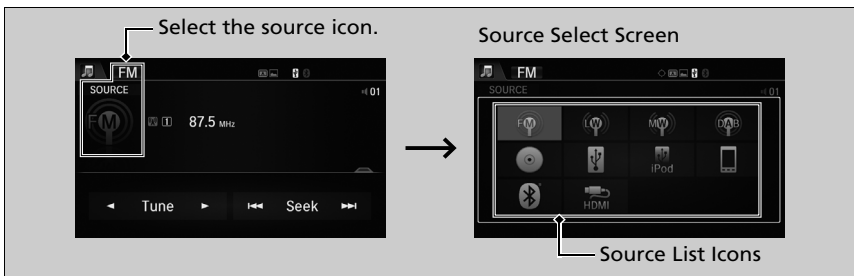

Select the current source icon, then select an icon on the source list to switch the audio source.

■ Limitations for Manual Operation

Certain manual functions are disabled or inoperable while the vehicle is in motion. You cannot select a grayed-out option until the vehicle is stopped.

▶▶ Selecting an Audio Source

If you startup preinstalled audio apps, **AUDIO Apps** is displayed on the upper left of the screen. These preinstalled apps cannot be displayed on the source select screen. You can startup those audio apps from **App/Widget List**.

Playing AM/FM Radio

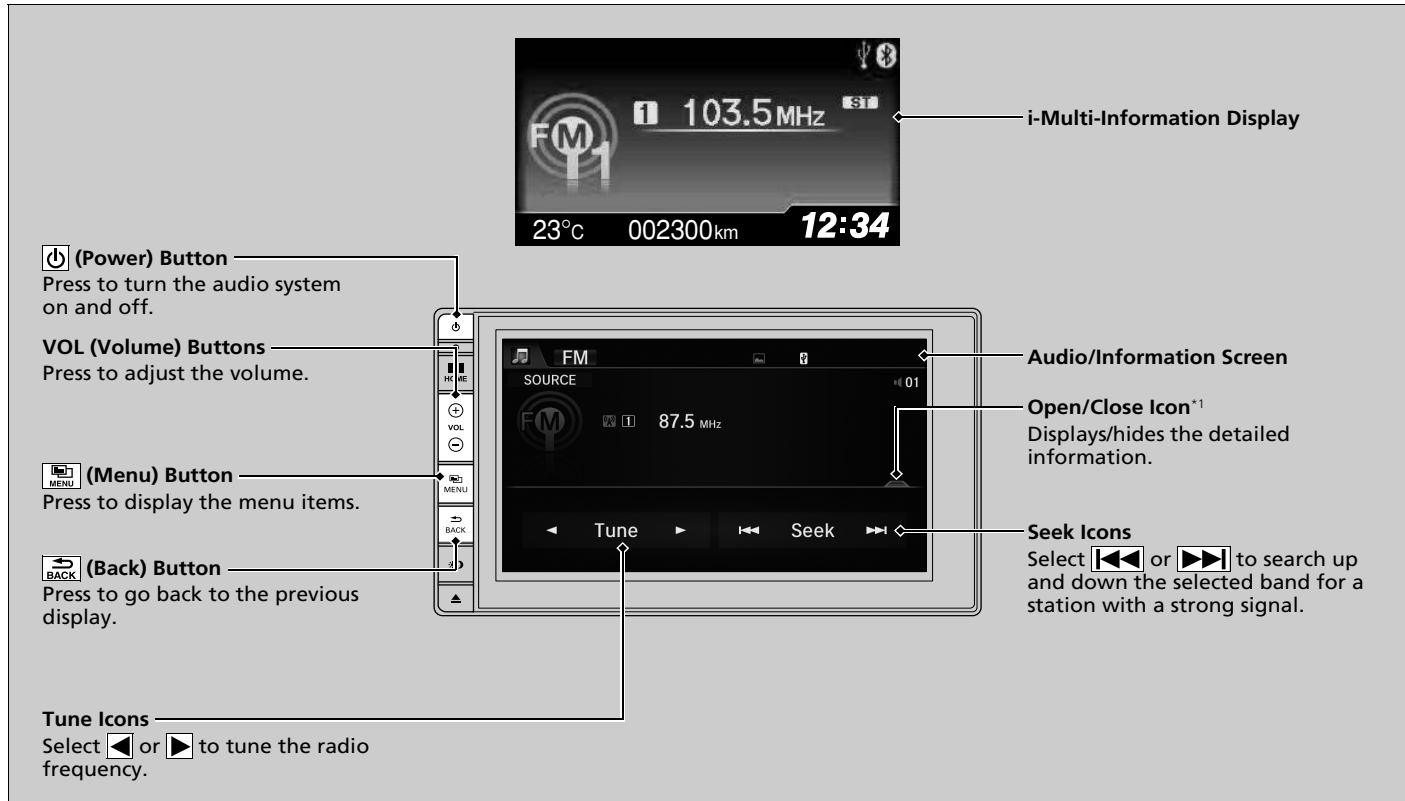

*1: Some or all of the lists may not be displayed.

■ Preset Memory

To store a station:

1. Tune to the selected station.
2. Press the  button.
3. Select **Save Preset**.
4. Select the preset number for the station you want to store.

■ Station List

Lists the strongest stations on the selected band.

1. Press the  button.
2. Select **Station List**.
3. Select the station.

■ Manual update

Updates your available station list at any time.

1. Press the  button.
2. Select **Station List**.
3. Select **Update List**.

▣ Preset Memory

The **ST** indicator appears on the display indicating stereo FM broadcasts.
Stereo reproduction in AM is not available.

Switching the Audio Mode

Press the **SOURCE** button on the steering wheel or select **SOURCE** on the screen.

 **Audio Remote Controls** P. 227

You can also switch the mode by selecting **Change Source** on the **Audio menu** screen.

You can store 6 AM stations and 12 FM stations into preset memory.

■ Scan

Samples each of the strongest stations on the selected band for 10 seconds.

1. Press the  button.
2. Select **Scan**.

To turn off scan, select **Cancel Scan**.

■ Radio Data System (RDS)

Provides text data information related to your selected RDS-capable FM station.

■ To find an RDS station from Station List

1. Press the  button while listening to an FM station.
2. Select **Station List**.
3. Select the station.

■ Manual update

Updates your available station list at any time.

1. Press the  button while listening to an FM station.
2. Select **Station List**.
3. Select **Update List**.

▶▶ Radio Data System (RDS)

When you select an RDS-capable FM station, the RDS automatically turns on, and the frequency display changes to the station name. However, when the signals of that station become weak, the display changes from the station name to the frequency.

■ Radio text

Displays the radio text information of the selected RDS station.

1. Press the  button.
2. Select **Radio Text**.

■ Scan

Samples each of the strongest stations on the selected band for 10 seconds.

1. Press the  button.
2. Select **Scan**.

To turn off scan, select **Cancel Scan**.

Playing DAB (Digital Audio Broadcasting)*

The diagram illustrates the car's audio system interface for playing DAB. It features a central **Audio/Information Screen** and a smaller **i-Multi-Information Display** at the top. The main screen shows the **DAB** source, station name **AAA**, and frequency **aaa**. It includes **Ensemble** and **Service** navigation icons. The i-Multi-Information Display shows a **DAB 1** logo, a frequency **2**, a website address, and the time **12:34**. The physical control panel includes a **Power** button, **VOL** buttons, **Menu** button, and **Back** button.

(Power) Button — Press to turn the audio system on and off.

VOL (Volume) Buttons — Press to adjust the volume.

(Menu) Button — Press to display the menu items.

(Back) Button — Press to go back to the previous display.

Ensemble Icons — Select ◀ or ▶ to tune the frequency.

i-Multi-Information Display

Audio/Information Screen

Open/Close Icon^{*1} — Displays/hides the detailed information.

Service Icons — Select ◀◀ or ▶▶ to search up and down the selected band for a station with a strong signal.

*1: Some or all of the lists may not be displayed.

* Not available on all models

■ Preset Memory

Stores a station:

1. Tune to the selected station.
2. Press the  button.
3. Select **Save Preset**.
4. Select the preset number for the station you want to store.

■ Ensemble List

Lists the strongest stations.

1. Press the  button.
2. Select **Ensemble List**.
3. Select the station.

■ Manual update

Updates your available station list at any time.

1. Press the  button.
2. Select **Ensemble List**.
3. Select **Update List**.

■ Scan

Samples each of the strongest stations on the selected band for 10 seconds.

1. Press the  button.
2. Select **Scan**.
3. Select **Scan Ensemble** or **Scan Service**.

To turn off scan, select **Cancel Scan**.

▶▶ Playing DAB (Digital Audio Broadcasting)*

Switching the Audio Mode

Press the **SOURCE** button on the steering wheel or select **SOURCE** on the screen.

 **Audio Remote Controls** P. 227

You can also switch the mode by selecting **Change Source** on the **Audio menu** screen.

You can store 12 DAB stations into preset memory.

■ Radio text

Displays the radio text information of the selected DAB station.

1. Press the  button.
2. Select **Radio Text**.

Models with navigation system

Playing a CD

Your audio system supports audio CDs, CD-Rs, and CD-RWs in either MP3 or WMA, or AAC*1 format. With the CD loaded, select the CD mode.

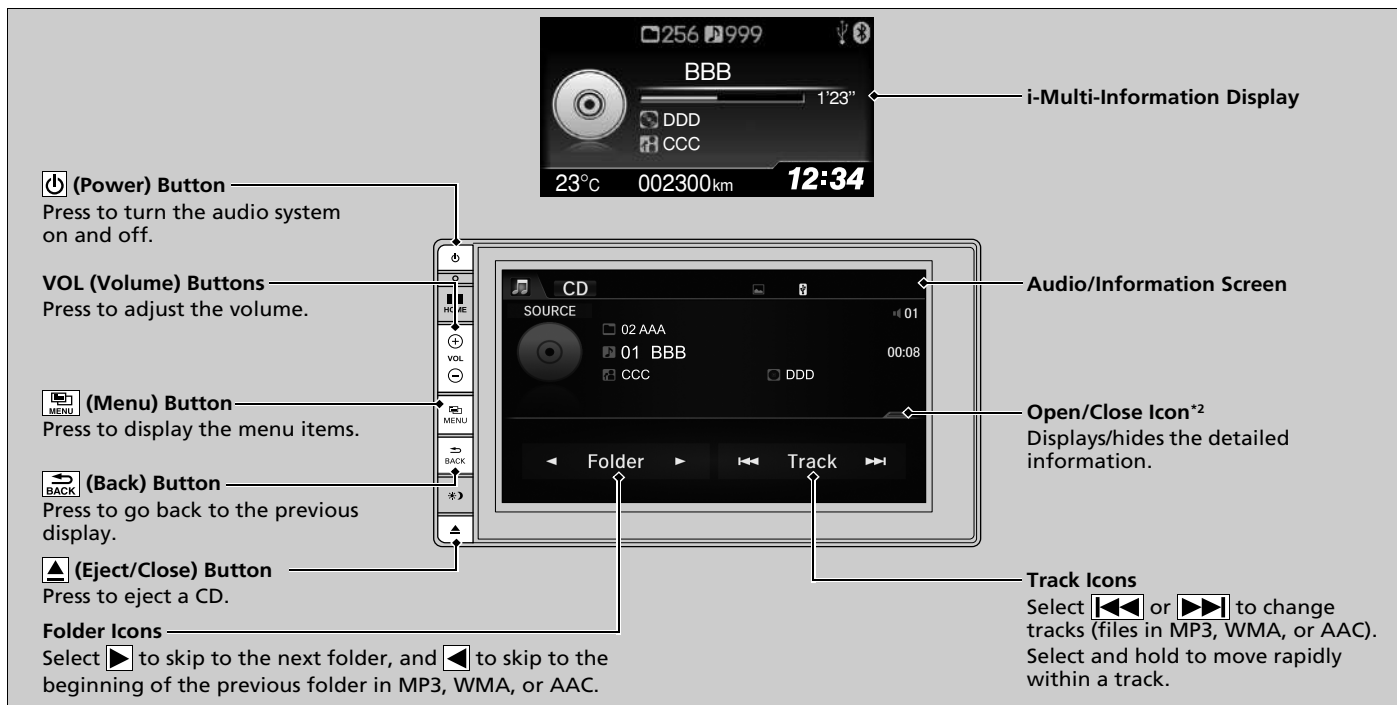

*1:Only AAC format files recorded with iTunes are playable on this unit.

*2:Some or all of the lists may not be displayed.

How to Select a File from the Music Search List (MP3/WMA/AAC)

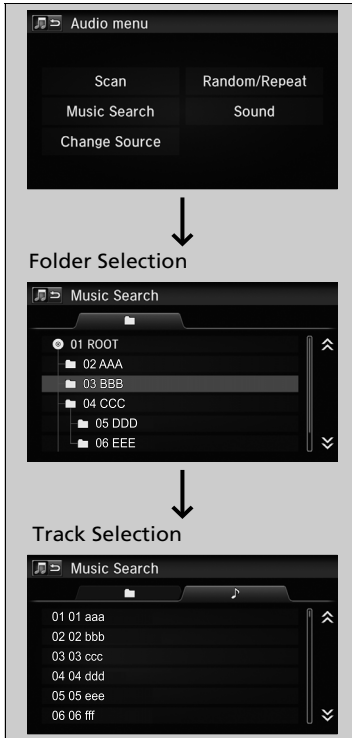

1. Press the  button and select **Music Search**.

2. Select a folder.

3. Select a track.

▶▶▶ Playing a CD

NOTICE

Do not use CDs with adhesive labels. The label can cause the CD to jam in the unit.

WMA files protected by digital rights management (DRM) cannot be played.

The audio system displays **Unplayable File**, then skips to the next file.

Text data appears on the display under the following circumstances:

- When you select a new folder, file, or track.
- When you change the audio mode to CD.
- When you insert a CD.

If you eject the CD but do not remove it from the slot, the system reloads the CD automatically after several seconds.

Continued

How to Select a Play Mode

You can select scan, repeat, and random modes when playing a track or file.



1. Press the  button.
2. Select **Scan** or **Random/Repeat**.
3. Select a mode.

To turn off a play mode

1. Press the  button.
2. Select the mode you want to turn off.

How to Select a Play Mode

Play Mode Menu Items

Scan

Scan Folders (MP3/WMA/AAC): Provides 10-second sampling of the first file in each of the main folders.

Scan Tracks: Provides 10-second sampling of all tracks on the CD (all files in the current folder in MP3, WMA, or AAC).

Random/Repeat

Repeat Folder (MP3/WMA/AAC): Repeats all files in the current folder.

Repeat Track: Repeats the current track/file.

Random in Folder (MP3/WMA/AAC): Plays all files in the current folder in random order.

Random All Tracks: Plays all tracks/files in random order.

Playing an iPod

Connect the iPod using your dock connector to the USB port, then select the iPod mode.

📌 **USB Port(s)** P. 223

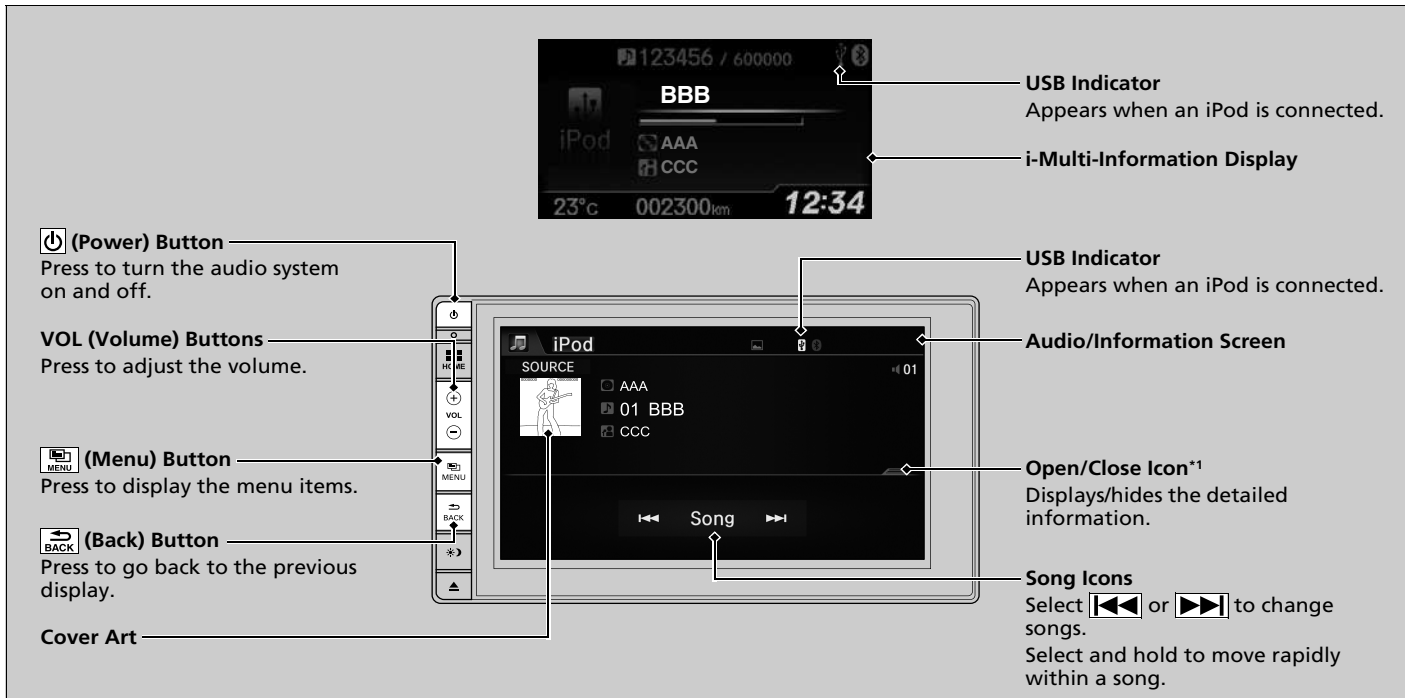

*1:Some or all of the lists may not be displayed.

How to Select a Song from the Music Search List

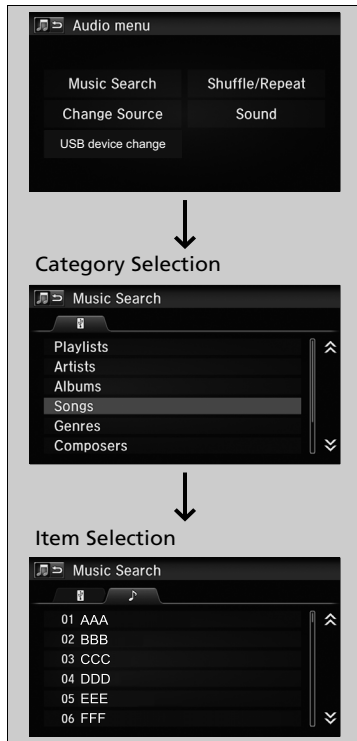

1. Press the  button and select **Music Search**.

2. Select the items on that menu.

▶▶ Playing an iPod

Available operating functions vary on models or versions. Some functions may not be available on the vehicle's audio system.

If there is a problem, you may see an error message on the audio/information screen.

 **iPod/USB Flash Drive** P. 305

If you operate the music app on your iPhone/iPod while the phone is connected to the audio system, you may no longer be able to operate the same app on the audio/information screen. Reconnect the device if necessary.

Select **USB device change** in the **Audio menu** screen to switch to another USB device.

■ How to Select a Play Mode

You can select repeat and shuffle modes when playing a file.

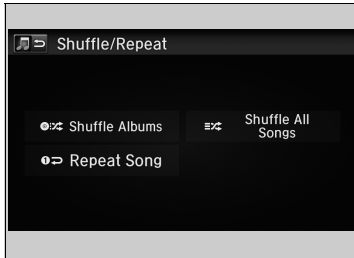

1. Press the  button.
2. Select **Shuffle/Repeat**.
3. Select a mode.

■ To turn off a play mode

1. Press the  button.
2. Select the mode you want to turn off.

▶▶ How to Select a Play Mode

Play Mode Menu Items

Shuffle Albums: Plays all available albums in a selected list (playlists, artists, albums, songs, podcasts, genres, composers, or audiobooks) in random order.

Shuffle All Songs: Plays all available files in a selected list (playlists, artists, albums, songs, podcasts, genres, composers, or audiobooks) in random order.

Repeat Song: Repeats the current track.

Playing a USB Flash Drive

Your audio system reads and plays sound and video files on a USB flash drive in either MP3, WMA, AAC*1, or WAV format.

Connect your USB flash drive to the USB port, then select the USB mode.

➤ **USB Port(s)** P. 223

(Power) Button
Press to turn the audio system on and off.

VOL (Volume) Buttons
Press to adjust the volume.

(Menu) Button
Press to display the menu items.

(Back) Button
Press to go back to the previous display.

Folder Icons
Select to skip to the next folder, and to skip to the beginning of the previous folder.

USB Indicator
Appears when a USB flash drive is connected.

i-Multi-Information Display

USB Indicator
Appears when a USB flash drive is connected.

Audio/Information Screen

Open/Close Icon*2
Displays/hides the detailed information.

Track Icons
Select or to change files. Select and hold to move rapidly within a track.

*1: Only AAC format files recorded with iTunes are playable on this unit.

*2: Some or all of the lists may not be displayed.

How to Select a File from the Music Search List

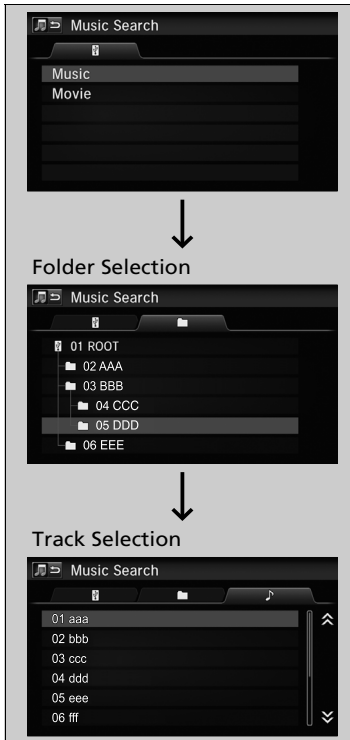

1. Press the  button and select **Music Search**.
2. Select **Music** or **Movie**.

3. Select a folder.

4. Select a track.

▶▶ Playing a USB Flash Drive

Use the recommended USB flash drives.

▶ **General Information on the Audio System**
P. 308

WMA files protected by digital rights management (DRM) cannot be played.

The audio system displays **Unplayable File**, then skips to the next file.

If there is a problem, you may see an error message on the audio/information screen.

▶ **iPod/USB Flash Drive** P. 305

Select **USB device change** in the **Audio menu** screen to switch to another USB device.

Continued

How to Select a Play Mode

You can select scan, repeat, and random modes when playing a file.

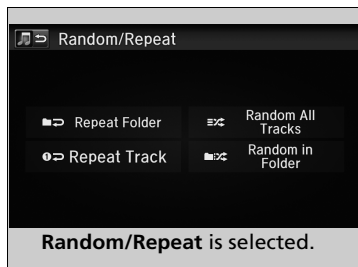

1. Press the  button.
2. Select **Scan** or **Random/Repeat**.
3. Select a mode.

To turn off a play mode

1. Press the  button.
2. Select the mode you want to turn off.

How to Select a Play Mode

Play Mode Menu Items

Scan

Scan Folder: Provides 10-second sampling of the first file in each of the main folders.

Scan Track (Scan Movies*¹): Provides 10-second sampling of all files in the current folder.

Random/Repeat

Repeat Folder: Repeats all files in the current folder.

Repeat Tracks (Repeat Movies*¹): Repeats the current file.

Random in Folder: Plays all files in the current folder in random order.

Random All Tracks (Random All Movies*¹): Plays all files in random order.

When playing a video file:

Play/Pause: Select to resume or play a file.

Stop: Select to stop a file.

*1: When playing a video file

Playing *Bluetooth*® Audio

Your audio system allows you to listen to music from your *Bluetooth*-compatible phone.

This function is available when the phone is paired and connected to the vehicle's Hands-Free Telephone (HFT) System.

☛ **Phone Setup** P. 359

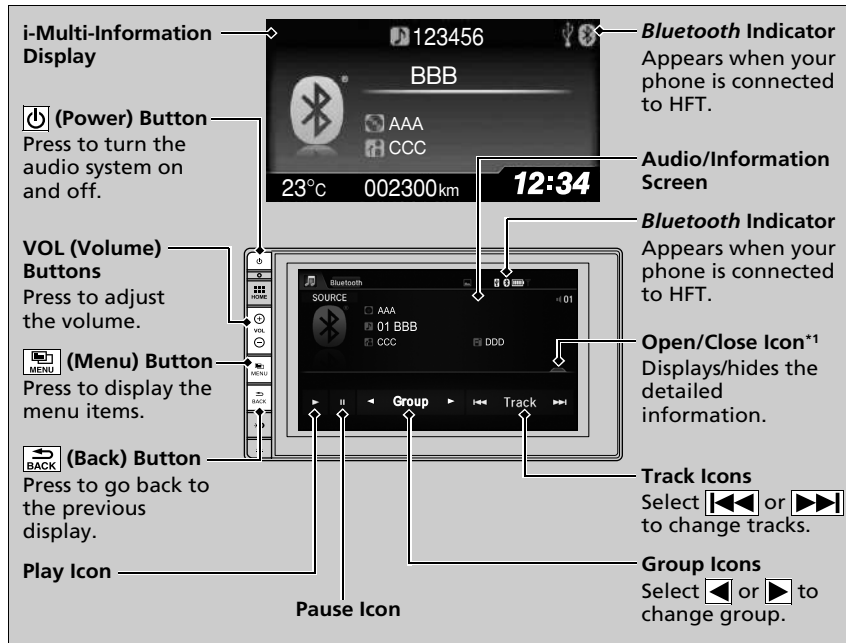

* 1: Depending on the *Bluetooth*® device you connect, some or all of the lists may not be displayed.

▶▶ Playing *Bluetooth*® Audio

Not all *Bluetooth*-enabled phones with streaming audio capabilities are compatible. To check if your phone is compatible, ask a dealer.

It may be illegal to perform some data device functions while driving.

Only one phone can be used with HFT at a time. When there are more than two paired phones in the vehicle, the first paired phone the system finds is automatically connected.

If more than one phone is paired to the HFT system, there may be a delay before the system begins to play.

In some cases, the name of the artist, album, or track may not appear correctly.

Some functions may not be available on some devices.

Continued

■ To Play *Bluetooth*® Audio Files

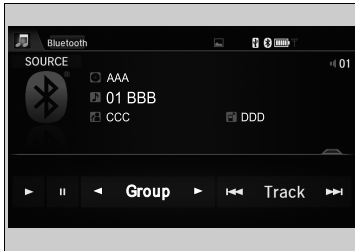



1. Make sure that your phone is paired and connected to the system.
 - ▶ **Phone Setup** P. 359
2. Select the *Bluetooth*® Audio mode.

If the phone is not recognised, another HFT-compatible phone, which is not compatible for *Bluetooth*® Audio, may already be connected.

- **To pause or resume a file**
Select the play icon or pause icon.

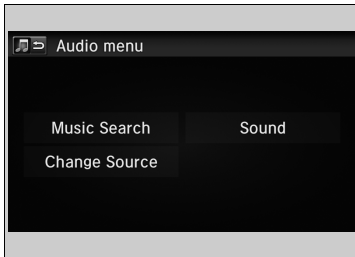
■ Searching for Music



1. Press the  button.
2. Select **Music Search**.
3. Select a search category (e.g., Albums).
4. Select an item.
 - ▶ The selection begins playing.

▶▶ To Play *Bluetooth*® Audio Files

To play the audio files, you may need to operate your phone. If so, follow the phone maker's operating instructions.

Switching to another mode pauses the music playing from your phone.

▶▶ Searching for Music

Depending on the *Bluetooth*® device you connect, some or all of the lists may not be displayed.

Playing a Video Using the HDMI™

Your audio system allows you to play videos from an HDMI-compatible device. Connect the device, using an HDMI™ cable, then select the HDMI™ mode.

📖 **HDMI™ Port*** P. 224

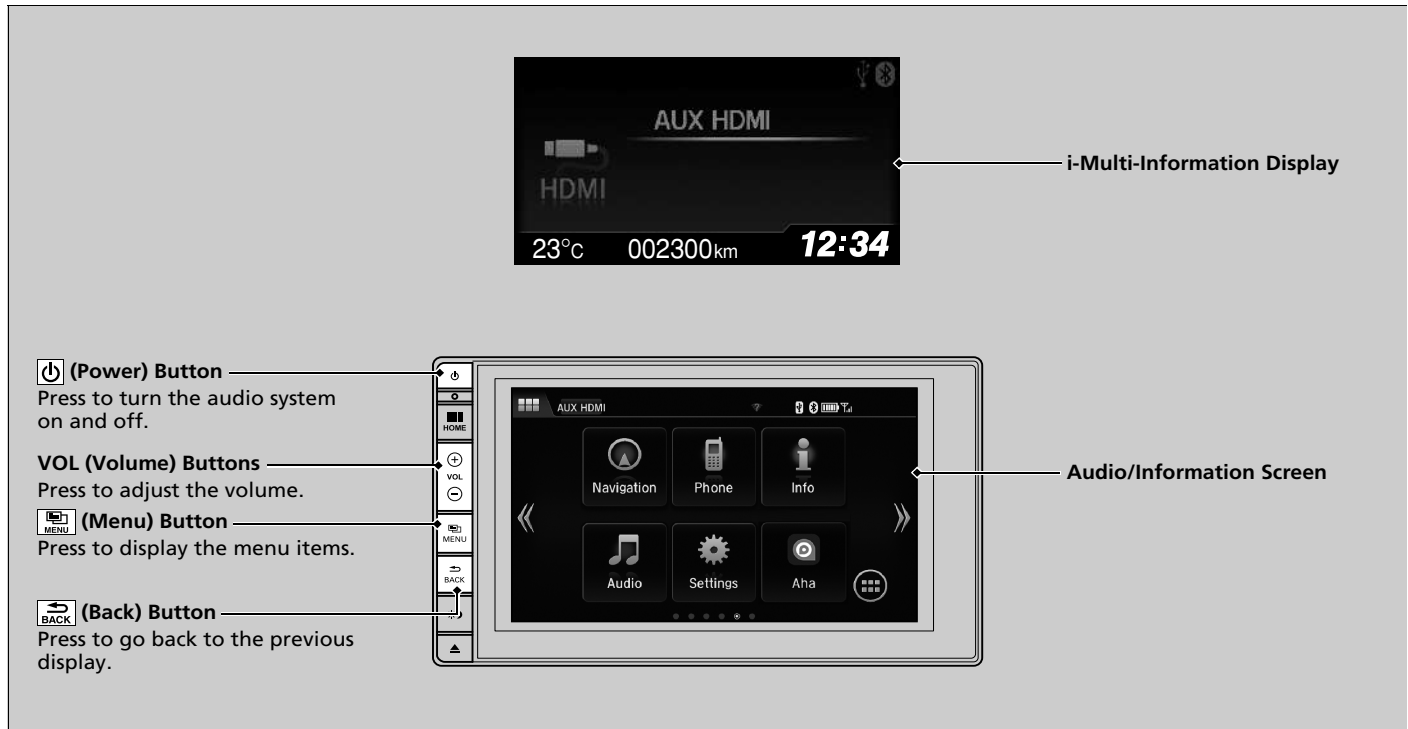

* Not available on all models

■ Changing the Screen Aspect

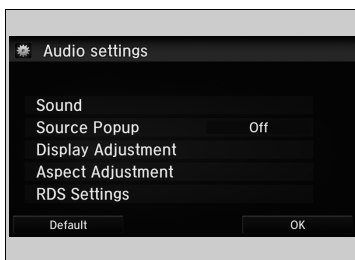

1. Press the  button.
2. Select **Settings**.
3. Select **Audio**.
4. Select **Aspect Adjustment**.
5. Select the setting you want.
6. Select **OK**.

▶▶ Playing a Video Using the HDMI™

This feature is limited while driving. To play videos, stop your vehicle and apply the parking brake.

On Board Apps

Honda Connect has the capability of On Board Apps which may be created by Honda or by 3rd parties. Apps may be already installed or can be downloaded through Honda App Center. Some Apps require internet access which can be established by Wi-Fi Connection.

📶 **Wi-Fi Connection** P. 301

Please visit the below web address for further information:

<https://ivhs.os.ixonos.com/honda/help>

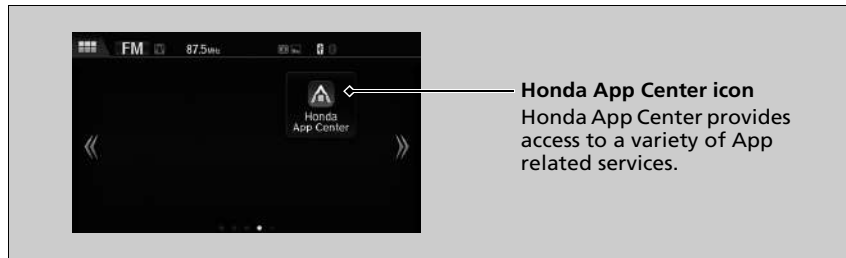

- Using the Display Audio system while driving can take your attention away from the road, causing a crash in which you could be seriously injured or killed. Only operate system controls when the conditions permit you to safely do so. **Please always adhere to the laws of the territory when operating this device.**
- Applications on the head unit are subject to change at anytime. This may mean that they are not available or operate differently. Honda shall not be liable to you in such instances.
- Applications available on the device may be provided by parties other than Honda to which 3rd party software licences and charges may apply.
- Data usage and roaming charges may result in using applications on the device in conjunction with your mobile phone and Honda is not liable for any costs you might incur from such use. Honda recommends you consult your mobile phone network provider in advance.
- Downloading applications from the Honda App Center will be subject to Terms and Conditions which can be found at: <https://ivhs.os.ixonos.com/honda/help>, and may also incur charges.

📶 On Board Apps

Make sure the GPS setting is turned on before using Honda App center.

📶 **Customized Features** P. 313

Even if you change **Background Colour** on the **System settings** screen, it will not be reflected on the Honda App Center screen.

Smartphone Connection

Some of your smartphone apps can be displayed and operated on the audio/information screen when the phone is connected to the audio system. You can connect your phone using a cable, or wirelessly.

➤ **Connecting Your iPhone** P. 300

➤ **Wi-Fi mode (setting for the first time)** P. 301

Smartphone Connection

Park in a safe place before connecting your phone and while operating the displayed apps.

Not all phones are compatible with the system. The system does not display all the available apps on your smartphone, and some apps need to be preinstalled. Ask a dealer for details.

You need to switch the *Bluetooth*® connection to your smartphone if another electronic device is connected.

➤ **To change the currently paired phone**
P. 360

The following may vary by phone type:

- How to connect a smartphone to the system.
- Apps that can be operated on the screen.
- Display response time/update time

We do not support every app operation on the audio system.

Ask the app provider for any queries on the app's features.

Do not get drawn into the display while operating a vehicle.

To use smartphone connection, you need to first pair your smartphone to the audio system via *Bluetooth*®.

📄 **Phone Setup** P. 359

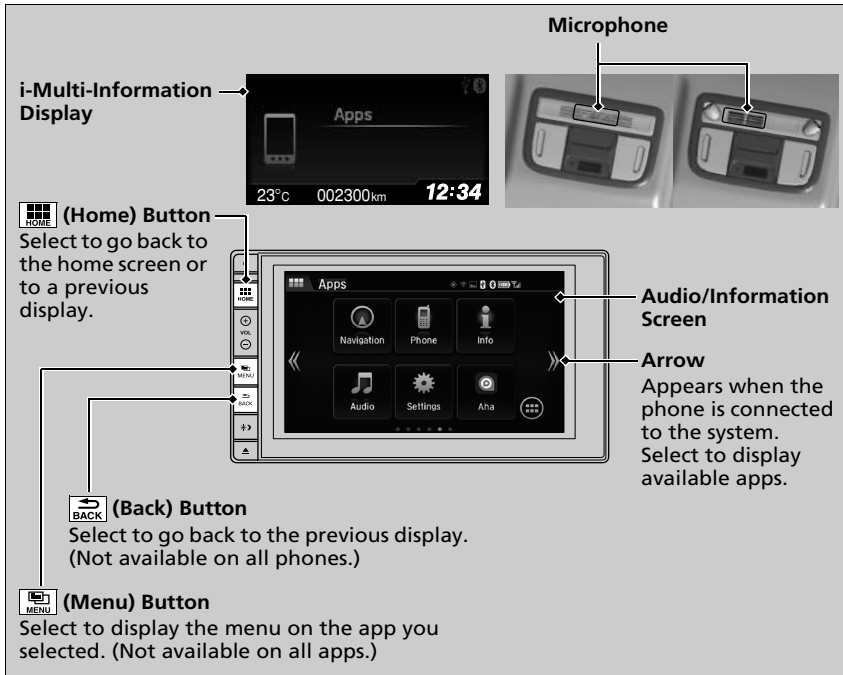

■ Connecting Your iPhone

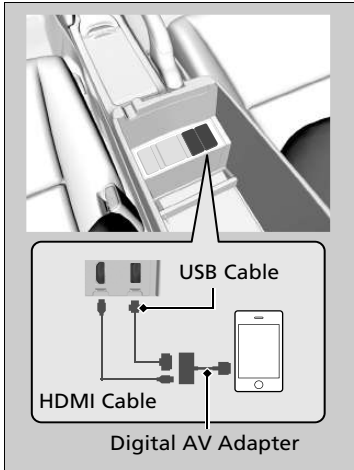

1. Connect your phone to the audio system via *Bluetooth*®.
▶ **Phone Setup** P. 359
2. Plug in the digital AV adapter to the HDMI™ jack.
3. Connect the digital AV adapter to your iPhone.
▶ Wait until an arrow appears on the home screen.
4. Select the arrow to display the available smartphone apps on the audio/information screen.
▶ You may need to operate from the phone.
5. Select an app you want to operate from the audio/information screen.
▶ To go back to the previous screen, press the  button.

☒ Connecting Your iPhone

Make sure to plug in the digital AV adapter to the HDMI™ jack first. If not, smartphone connection may not work properly.

To recharge your phone, connect it to the USB jack, too.

Contact a dealer for the digital AV adapter or HDMI™ cable purchasing information.

Wi-Fi Connection

You can connect the display audio system to the Internet using Wi-Fi and browse websites or use online services on the audio/information screen. If your phone has mobile hotspot capabilities, the system can be tethered to the phone. Go through the following steps for a setup.

Wi-Fi mode (setting for the first time)



1. Press the  button.
2. Select **Settings**.
3. Select **Bluetooth / Wi-Fi**.
4. Select the **Wi-Fi** tab.
5. Select **Wi-Fi On/Off Status**, then **On**.
6. Select **Wi-Fi Device List**.
 - ▶ Make sure your phone's Wi-Fi setting is in access point (tethering) mode.
 - ▶ Select the phone you want to connect to the system.
 - ▶ If you do not find the phone you want to connect in the list, select **Scan**.

Wi-Fi mode (setting for the first time)

You cannot go through the setting procedure while a vehicle is moving. Park in a safe place to set the audio system in Wi-Fi mode.

Some telecom carriers charge for tethering. Check your phone's subscribed package.

Check your phone manual to find out if the phone has Wi-Fi connectivity.

You can confirm whether Wi-Fi connection is on or off with the  icon on **Wi-Fi Device list**. Transmission speed and others will not be displayed on this screen.

Continued

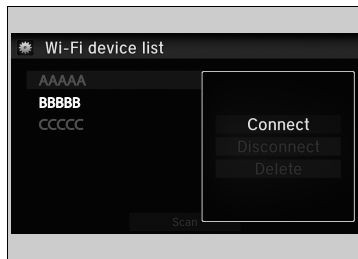

7. Select **Connect**.

▶ Enter a password for your phone, and select **Done**.

▶ When the connection is successful, the  icon is displayed on the list.

8. Press the  button to go back to the home screen.

» Wi-Fi mode (setting for the first time)

If you cannot enter the password on the displayed keyboard, change the keyboard to the one in which you can enter from the following order:

Settings → **Android** → **Language & input** → select  next to **Android keyboard** → **Input language** → uncheck the box next to **Use system language** → select the keyboard languages that you can enter.

» Wi-Fi mode (after the initial setting has been made)

iPhone users

You may need to go through an initial setup for Wi-Fi connection again after you boot your phone.

Wi-Fi mode (after the initial setting has been made)

Make sure your phone's Wi-Fi setting is in access point (tethering) mode.

Siri Eyes Free

You can talk to Siri using the  (Talk) button on the steering wheel when your iPhone is paired to the Hands-Free Telephone (HFT) System.

➤ **Phone Setup** P. 359

Using Siri Eyes Free

(Hang-up/back) Button

Press to deactivate Siri.

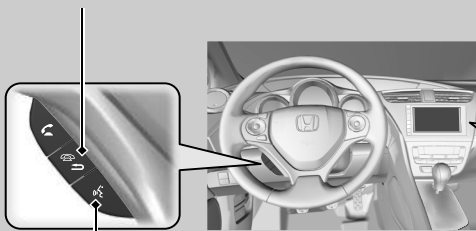

(Talk) Button

Press and hold until the display changes as shown.

Appears when Siri is activated in Siri Eyes Free

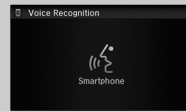

While in Siri Eyes Free:
The display remains the same.
No feedback or commands appears.

☒ Siri Eyes Free

Siri is a trademark of Apple Inc.

Check Apple Inc. website for features available for Siri.







We recommend against using Siri other than in Siri Eyes Free while operating a vehicle.

☒ Using Siri Eyes Free

Some commands work only on specific phone features or apps.

CD Player*

If a disc error occurs, you may see the following error messages.

Error Message	Cause	Solution
Heat Error	High temperature	<ul style="list-style-type: none"> Turn the audio system off and allow the player to cool down until the error message is cleared.
Unsupported^{*1}	Track/file format not supported	<ul style="list-style-type: none"> Current track/file will be skipped. The next supported track/file plays automatically.
Unplayable File^{*2}		
Bad Disc Please check owners manual. Push Eject^{*1}	Mechanical error	<ul style="list-style-type: none"> Press the  (CD Eject)^{*1}/ (Eject/Close)^{*2} button and remove the disc, and check that the error message is cleared. Check that the disc is not damaged or deformed, and insert the disc again. <ul style="list-style-type: none">  Protecting CDs P. 309 If the error message reappears, press the  (CD Eject)^{*1}/ (Eject/Close)^{*2} button, and pull out the disc. Insert a different disc.
Bad Disc Please Check Owner's Manual Push Eject^{*2}		
Mecha Error		
Bad Disc Please check owners manual.^{*1}	Servo error	<ul style="list-style-type: none"> If the new disc plays, there is a problem with the first disc. If the error message repeats, or the disc cannot be removed, contact a dealer.
Bad Disc Please Check Owner's Manual^{*2}		
Check Disc	Disc error	<ul style="list-style-type: none"> Check that the disc is not damaged or deformed. <ul style="list-style-type: none">  Protecting CDs P. 309

*1:Models with one display

*2:Models with two displays

iPod/USB Flash Drive

If an error occurs while playing an iPod or USB flash drive, you may see the following error messages. If you cannot clear the error message, contact a dealer.

Error Message	Solution
USB Error	Appears when there is a problem with the USB adapter unit. Check if the device is compatible with the USB adapter unit.
Incompatible USB device Please check owners manual.*¹	Appears when an incompatible device is connected. Disconnect the device. Then turn the audio system off, and turn it on again. Do not reconnect the device that caused the error.
Incompatible USB Device Please Check Owner's Manual*²	
No Song*¹	Appears when the iPod is empty. Check that compatible files are stored on the device.
Unsupported Ver*¹	Appears when an unsupported iPod is connected. If it appears when a supported iPod is connected, update the iPod software to the newer version.
Unsupported Version*²	
Retry Connection*¹	Appears when the system does not acknowledge the iPod. Reconnect the iPod.
Connect Retry*²	
Unplayable File	Appears when the files in the USB flash drive are DRM or an unsupported format. This error message appears for about three seconds, then plays the next song.

*1:Models with one display

*2:Models with two displays

Error Message	Solution
No Data	iPod *1 Appears when the iPod is empty. Check that compatible files are stored on the device. USB flash drive Appears when the USB flash drive is empty or there are no MP3, WMA, or AAC files in the USB flash drive. Check that compatible files are stored on the device.
Unsupported	Appears when an unsupported device is connected. If it appears when a supported device is connected, reconnect the device.

*1: Models with two displays

Models with two displays

Android/Apps

If an error occurs while using the audio system or apps, you may see the following error messages. If you cannot clear the error message, contact a dealer.

Error Message	Solution
Unfortunately, **** has stopped.	<p>Error has occurred within app, select OK on the screen to close the app. Unless it is a fatal error, it would return to normal if you startup the app.</p> <p>If it does not return to normal even after starting up the app, press and hold the  (power) button to perform the forced reset. If it still does not get back to normal, you need Factory Data Reset.</p> <p>➤ Defaulting All the Settings P. 328</p>
**** is not responding. Would you like to close it?	<p>App is in a busy state.</p> <p>Select Wait if you can wait for a response from app a little longer. If it does not respond even if you keep waiting, select OK to close the app and start it up. When it does not return to normal, press and hold the  (power) button to perform the forced reset. You also need Factory Data Reset.</p> <p>➤ Defaulting All the Settings P. 328</p>
Security warning	<p>Occurs if you open the browser when the system date is older than the certificate date information. It also occurs when you are in the area where GPS reception is unavailable or GPS setting of the Android setting is turned off.</p> <ul style="list-style-type: none"> • Turn on GPS setting of the Android setting. • Move to the area where GPS reception is available. <p>➤ Customized Features P. 313</p>

*1:****part is variable characters, and will change depending upon where an error occurs.

Recommended CDs*

- Use only high-quality CD-R or CD-RW discs labelled for audio use.
- Use only CD-R or CD-RW discs on which the recordings are closed.
- Play only standard round-shaped CDs.

The CD packages or jackets should have one of these marks.



CDs with MP3, WMA, or AAC* files

- Some software files may not allow for audio play or text data display.
- Some versions of MP3, WMA, or AAC* formats may be unsupported.

Recommended CDs*

A Dual-disc cannot play on this audio unit. If recorded under certain conditions, a CD-R or CD-RW may not play either.

■ Protecting CDs

Follow these precautions when handling or storing CDs:

- Store a CD in its case when it is not being played.
- When wiping a CD, use a soft clean cloth from the centre to the outside edge.
- Handle a CD by its edge. Never touch either surface.
- Never insert foreign objects into the CD player.
- Keep CDs out of direct sunlight and extreme heat.
- Do not place stabilizer rings or labels on the CD.
- Avoid fingerprints, liquids, and felt-tip pens on the CD.

▶▶ Protecting CDs

NOTICE

Do not insert a damaged CD. It may get stuck inside and damage the audio unit.

Examples:

- Bubbled, wrinkled, labelled, and excessively thick CDs



Bubbled/
Wrinkled

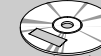

With Label/
Sticker



Using Printer
Label Kit

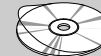

Sealed



With Plastic Ring

- Damaged CDs

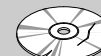

Chipped/
Cracked

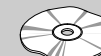

Warped



Burrs

- Poor quality CDs

- Small CDs



8-cm
(3-inch)
CD

Compatible iPod, iPhone, and USB Flash Drives

■ iPod and iPhone Model Compatibility

Model
iPod (5th generation)
iPod classic 80GB/160GB (launch in 2007)
iPod classic 120GB (launch in 2008)
iPod classic 160GB (launch in 2009)
iPod nano (1st to 6th generation) launch in 2010
iPod nano (7th generation) launch in 2012
iPod touch (1st to 4th generation) launch in 2010
iPod touch (5th generation) launch in 2012
iPhone 3G/iPhone 3GS/iPhone 4/iPhone 4s/iPhone 5/iPhone 5c* ¹ /iPhone 5s* ¹

■ USB Flash Drives

- Use a recommended USB flash drive of 256 MB or higher.
- Some digital audio players may not be compatible.
- Some USB flash drives (e.g., a device with security lockout) may not work.
- Some software files may not allow for audio play or text data display.
- Some versions of MP3, WMA, AAC, or WAV* formats may be unsupported.

*1: Models with two displays

* Not available on all models

⌘ iPod and iPhone Model Compatibility

This system may not work with all software versions of these devices.

⌘ USB Flash Drives

Files on the USB flash drive are played in their stored order. This order may be different from the order displayed on your PC or device.

■ Recommended Devices *

Media	USB Flash Drive	
Profile (MP4 version)	Baseline Level 3 (MPEG4-AVC), Simple Level 5 (MPEG4)	
File extension (MP4 version)	.mp4/.m4v	
Compatible audio codec	MPEG4-AVC (H.264)	MPEG4 (ISO/IEC 14496 Part.2)
Bit rate	10 Mbps (MPEG4-AVC)	8 Mbps (MPEG4)
Maximum image	720 X 576 pixels	

* Not available on all models



About Open Source Licences

To see the open source licence information, follow these steps.

1. Select .
2. Select **Settings**.
3. Select **Android**.
4. Select **About device**.
5. Select **Legal information**.
6. Select **Open source licences**.

▶ About Open Source Licences

You can also go to step 4 when you:

- Swipe down from the top.
- ▶ Select  appears on the screen.
- Select , then select **Settings** on the **App** tab.

Customized Features

Models with two displays

Use the audio/information screen to customize certain features.

■ How to customize

With the ignition switch in ON *1, select **Settings**, then select a setting item.

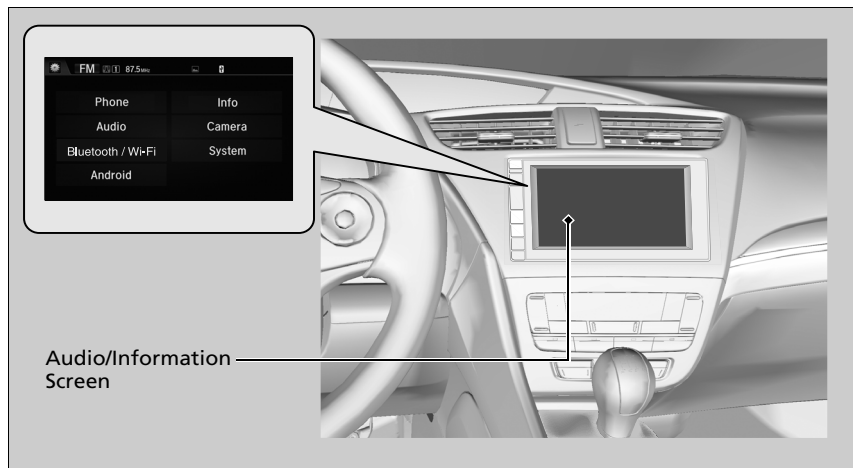

*1: Models with the keyless access system have an **ENGINE START/STOP** button instead of an ignition switch.

Customized Features

When you customize settings, make sure that the vehicle is at a complete stop and shift to **P**.

To customize other features, select **Settings**.

➤ **List of customizable options** P. 318

If you press and hold the  (power) button when resetting the system, it may restore the customized value to its default value depending on the setting items.

■ Customization flow

Press the  button.

Select **Settings**.

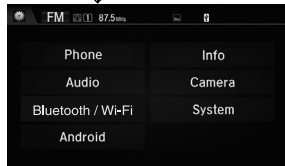

System

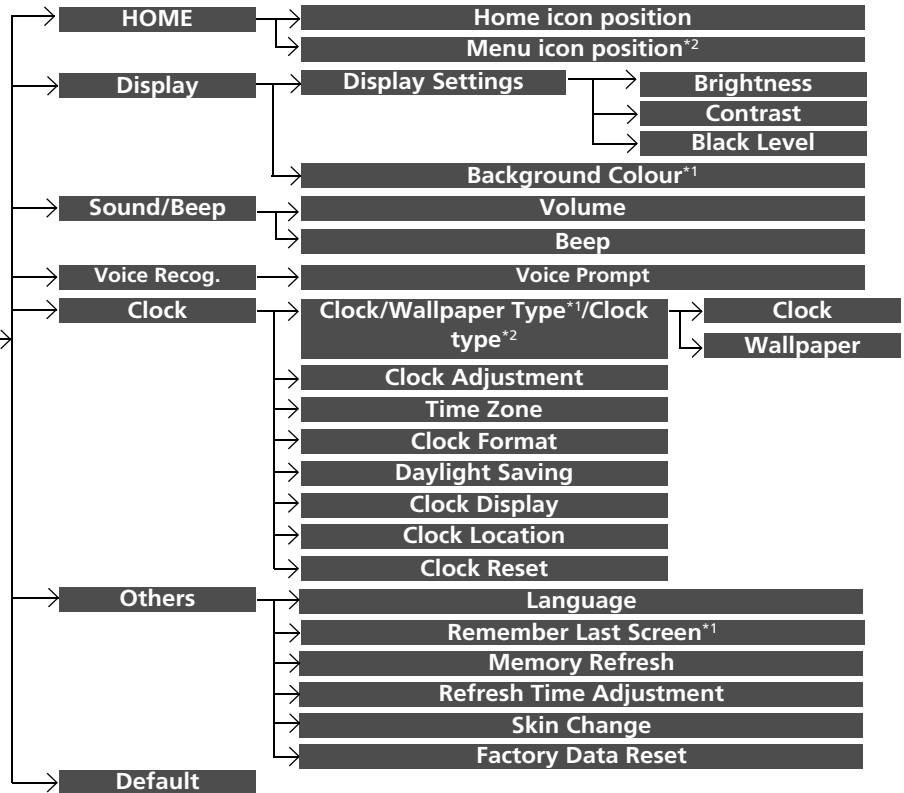

*1: Does not appear when you change the screen interface design.

*2: Appears only when you change the screen interface design.

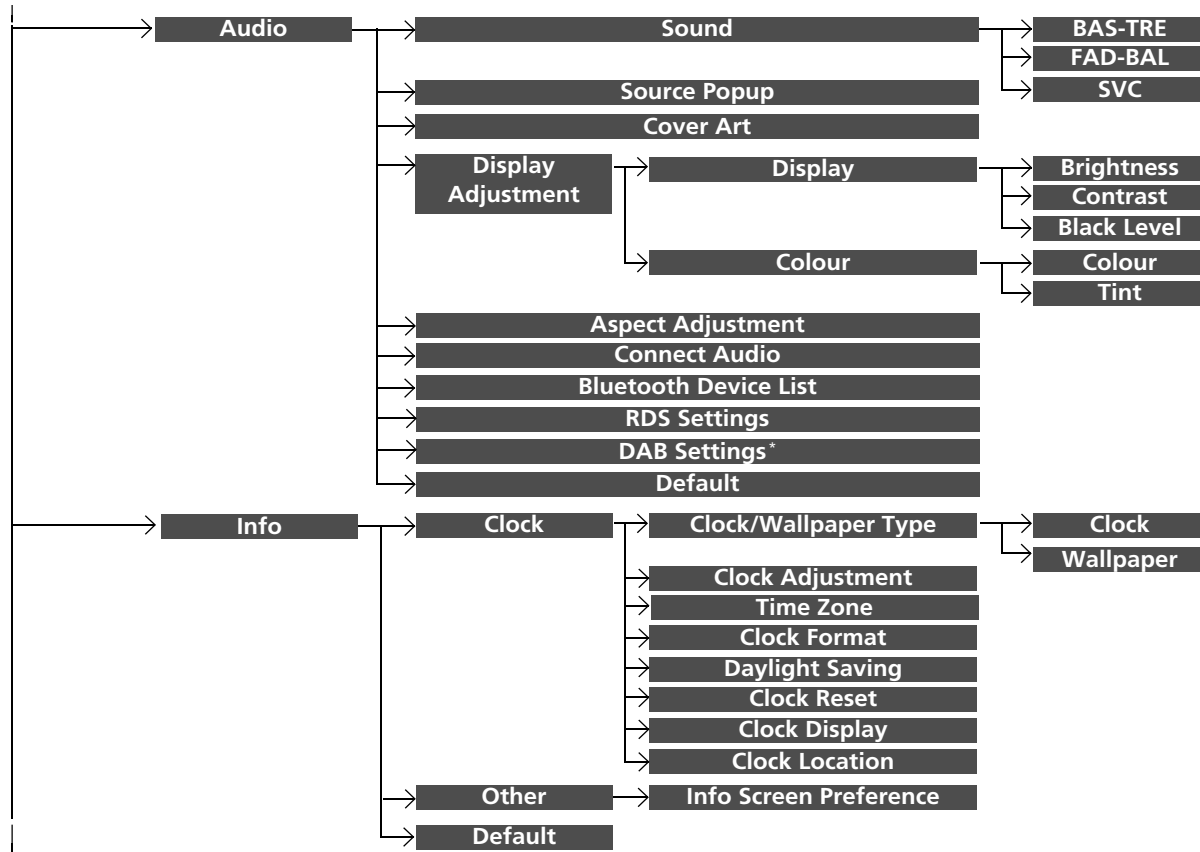

* Not available on all models

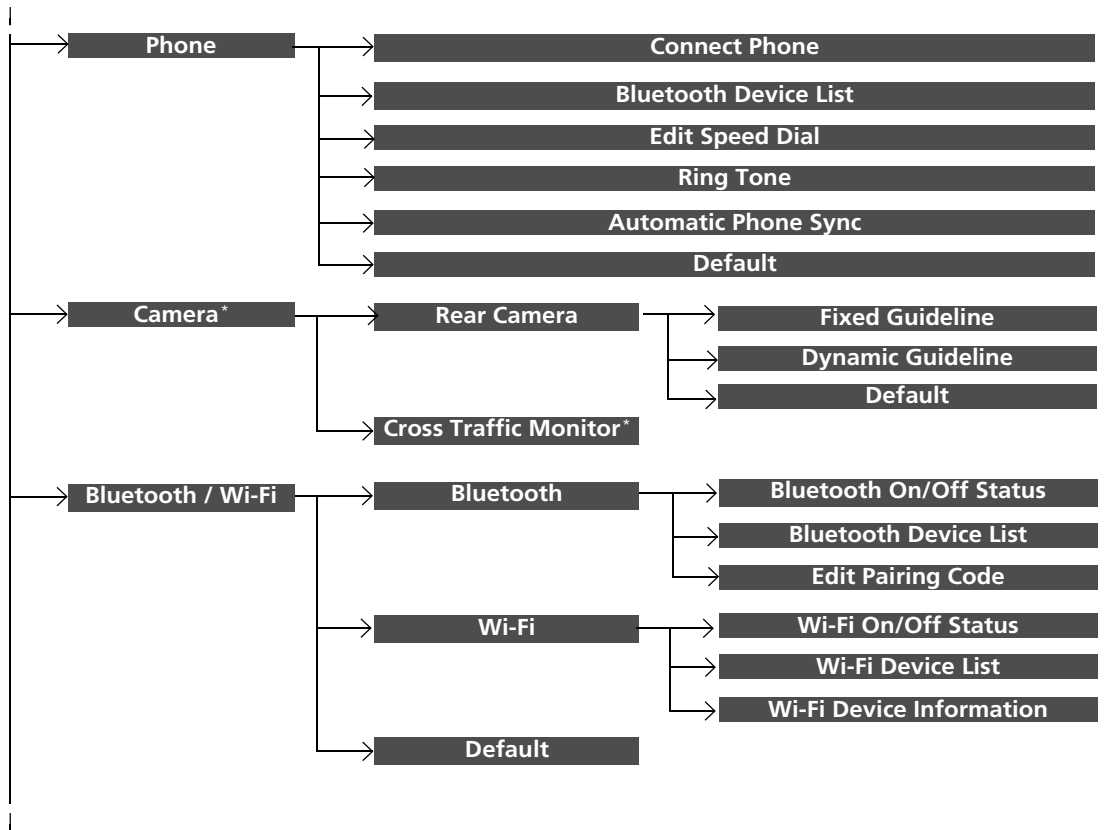

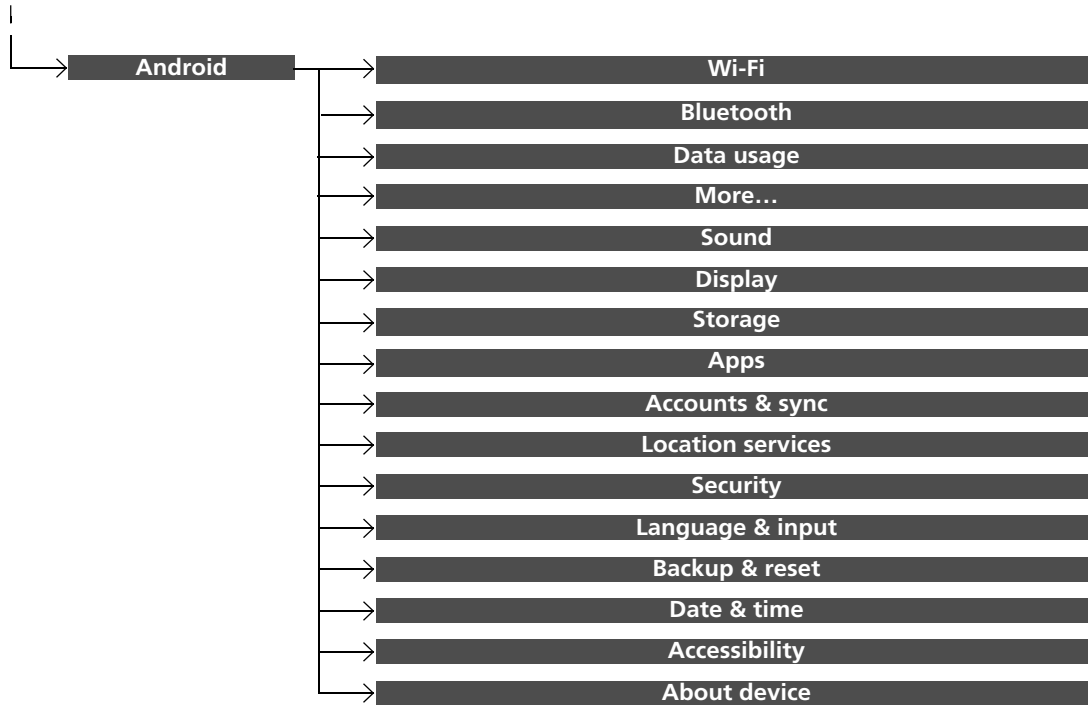

■ List of customizable options

Setup Group	Customizable Features	Description	Selectable Settings	
System	HOME	Home icon position	Changes the home screen icon layout.	—
		Menu icon position ^{*3}		
	Display Settings	Brightness	Changes the brightness of the audio/information screen.	—
		Contrast	Changes the contrast of the audio/information screen.	—
		Black Level	Changes the black level of the audio/information screen.	—
		Display		
	Background Colour ^{*2}	Changes the background colour of the audio/information screen.	1.4 L engine, 1.8 L engine, and diesel engine models Blue ^{*1} /Amber/Red/Violet 2.0 L engine models Blue/Amber/Red ^{*1} /Violet	
	Sound/Beep	Volume	Changes the sound volume. Adjusts the guidance volume of the navigation system.	0~6 ^{*1} ~11
		Beep	Changes the beep volume.	Off/1/2 ^{*1} /3
	Voice Recog.	Voice Prompt	Turns the voice prompt on and off.	On ^{*1} /Off

*1:Default Setting

*2:Does not appear when you change the screen interface design.

*3:Appears only when you change the screen interface design.

Setup Group	Customizable Features	Description	Selectable Settings	
System	Clock/ Wallpaper ^{*2} / Clock type ^{*3}	Clock	Changes the clock display type.	Analog/Digital ^{*1} / Small Digital/Off
		Wallpaper	<ul style="list-style-type: none"> Changes the wallpaper type. Imports an image file for a new wallpaper. Deletes an image file for a wallpaper. 	Galaxy ^{*1} /Metallic/ Blank
		Clock Adjustment	Adjusts clock. ▶ Adjusting the Clock P. 148	—
		Time Zone	Changes the time zones.	WET/GMT ^{*1}
		Clock Format	Selects the digital clock display from 12H to 24H.	12H ^{*1} /24H
		Daylight Saving	Adjusts the clock automatically when a summer time change occurs.	On ^{*1} /Off
		Clock Display	Selects whether the clock display comes on.	On/Off ^{*1}
		Clock Location	Changes the clock display layout.	Upper right ^{*1} /Upper left/ Lower right/ Lower left
		Clock Reset	Resets the clock settings to the factory default.	—

*1:Default Setting

*2:Does not appear when you change the screen interface design.

*3:Appears only when you change the screen interface design.

Setup Group	Customizable Features	Description	Selectable Settings
System	Language	Changes the display language.	English (United Kingdom)*1 : See other selectable languages on the screen.
	Remember Last Screen*2	Selects whether the device remembers the last screen.	On/Off*1
	Others Memory Refresh	Turns on the audio system automatically and restores the fragmentation of a memory when the ignition switch is LOCK <input type="checkbox"/> *3.	On*1/Off
	Refresh Time Adjustment	Sets the time for Memory Fresh .	00:00~02:00*1~23:59
	Skin Change	Changes the screen interface design.	—
	Factory Data Reset	Resets all the settings to their factory default. <input checked="" type="checkbox"/> Defaulting All the Settings P. 328	Yes/No
Default		Cancels/Resets all customized items in the System settings group as default.	Yes/No
Audio	Sound	Adjusts the settings of the audio speakers' sound. <input checked="" type="checkbox"/> Adjusting the Sound P. 274	-6 ~ 0*1 ~ +6 (BASS and TREBLE), RR9~0*1~FR9 (FADER), L9~0*1~R9 (BALANCE), Off/Low/Mid*1/High (Speed Volume Compensation)

*1:Default Setting

*2:Does not appear when you change the screen interface design.

*3:Models with the keyless access system have an **ENGINE START/STOP** button instead of an ignition switch.

Setup Group	Customizable Features	Description	Selectable Settings		
Audio	Source Popup	Selects whether the list of selectable audio sources comes on when Audio is selected on the home screen.	On/Off *1		
	CD, iPod, USB mode Cover Art	Turns the cover art display on and off.	On *1/ Off		
	Display Adjustment	Display	Brightness	See System on P. 318	
			Contrast		
		Colour	Black Level		—
			Colour		
	Tint	Changes the tint of the audio/information screen.	—		
	USB, HDMI™ mode Aspect Adjustment	Selects the display mode with a different aspect ratio from Original (only USB), Normal , Full and Zoom .	Original (only USB)/ Normal/Full *1/ Zoom		
	Bluetooth® Audio mode Connect Audio	Connects, disconnects or pairs a <i>Bluetooth®</i> Audio device to HFT.	—		
	Bluetooth® Audio mode Bluetooth Device List	Pairs a new phone to HFT, edits or deletes a paired phone. ☞ Phone Setup P. 359	—		



*1:Default Setting

Setup Group	Customizable Features	Description	Selectable Settings	
Audio	TA-Information	Turns on and off the traffic information.	On/Off * ¹	
	News	Turns on and off to automatically to tune to the news programme.	On/Off * ¹	
	RDS Settings	REG	Turns on and off to keep the same stations within that region even if the signal gets weak.	On * ¹ / Off
	AF	Turns on and off to automatically change the frequency of the same programme as you enter different regions.	On * ¹ / Off	
	DAB Settings*	DAB-DAB Link	Selects whether the system automatically searches for the same station from Ensembles, and switches to it.	On * ¹ / Off
	DAB-FM Link	Selects whether the system finds the same station from an FM band, and automatically switches the band.	On * ¹ / Off	
	Band select	Selects specific bands to reduce the time to update the lists, and search for a station.	BOTH * ¹ / BAND III/L-BAND	
Default		Cancels/Resets all customized items in the Audio settings group as default.	Yes/No	

* 1: Default Setting

Setup Group	Customizable Features	Description	Selectable Settings			
Info	<table border="1"> <tr> <td rowspan="2">Clock/ Wallpaper Type</td> <td>Clock</td> </tr> <tr> <td>Wallpaper</td> </tr> </table>	Clock/ Wallpaper Type	Clock	Wallpaper	See System on P. 319	
	Clock/ Wallpaper Type		Clock			
		Wallpaper				
	Clock Adjustment					
	Time Zone					
	Clock Format					
	Daylight Saving					
	Clock Reset					
	Clock Display					
	Clock Location					
Other	Info Screen Preference	Changes the information screen type.	Info Top/Info Menu/ Off ^{*1}			
Default		Cancels/Resets all customized items in the Info settings group as default.	Yes/No			

*1:Default Setting

Setup Group	Customizable Features	Description	Selectable Settings
Phone	Connect Phone	Pairs a new phone to HFT, connects or disconnects a paired phone.  Phone Setup P. 359	—
	Bluetooth Device List	Pairs a new phone to HFT, edits or deletes a paired phone.  Phone Setup P. 359	—
	Edit Speed Dial	Edits, adds or deletes a speed dial entry.  Speed Dial P. 365	—
	Ring Tone	Selects the ring tone.	Fixed/Mobile phone *1
	Automatic Phone Sync	Sets phonebook and call history data to be automatically imported when a phone is paired to HFT.	On/Off
	Default	Cancels/Resets all customized items in the Phone settings group as default.	Yes/No

* 1: Default Setting

Setup Group	Customizable Features	Description	Selectable Settings
Camera*	Rear Camera	Fixed Guideline Selects whether the fixed guidelines come on the rear camera monitor. ➤ Rearview Camera* P. 451	On*/Off
		Dynamic Guideline Selects whether the dynamic guidelines come on the rear camera monitor. ➤ Rearview Camera* P. 451	On*/Off
		Default Cancels/Resets all customized items in the Rear Camera setting group as default.	Yes/No
	Cross Traffic Monitor*	Turns on and off the cross traffic monitor.	On/Off
Bluetooth / Wi-Fi		Bluetooth On/Off Status Selects to display the <i>Bluetooth</i> ® status.	On*/Off
	Bluetooth	Bluetooth Device List Pairs a new phone to HFT, edits or deletes a paired phone, or creates a security PIN. ➤ Phone Setup P. 359	—
		Edit Pairing Code Edits a pairing code. ➤ To change the pairing code setting P. 360	Random/Fixed* ¹
		Wi-Fi On/Off Status Changes the Wi-Fi mode.	On*/Off
	Wi-Fi	Wi-Fi Device List Connects, disconnects, or deletes the Wi-Fi device.	—
		Wi-Fi Device Information Shows the Wi-Fi information of the device.	—
	Default Cancels/Resets all customized items in the Bluetooth / Wi-Fi settings group as default.	Yes/No	

*1:Default Setting

* Not available on all models

Setup Group	Customizable Features	Description	Selectable Settings
Android	Wi-Fi	Shows the status of the Wi-Fi connection (On/Off) and adds new Wi-Fi networks.	On^{*1}/Off
	Bluetooth	Shows the status of the <i>Bluetooth</i> ® connection (On/Off) and adds new <i>Bluetooth</i> ® devices.	On^{*1}/Off
	Data usage	Shows the data usage of the system.	—
	More...	Adds VPN (Virtual Private Network).	—
	Sound	Adjusts the alarm volume and selects the favorite sound.	—
	Display	Sets up the wallpaper and changes the font size.	—
	Storage	Shows the storage capacity of the system and the USB capacity.	—
	Apps	Shows the status of the installed apps.	—
	Accounts & sync	Adds the additional account information.	—
	Location services	Turn on/off the GPS setting before using apps.	—
	Security	Shows the security status of the system.	—
	Language & input	Changes the display language of the system and the input keyboard.	—
	Backup & reset	Resets the system.	—
Date & time	Changes the date, the time zones, and the clock format.	—	

*1:Default Setting

Setup Group	Customizable Features	Description	Selectable Settings
Android	Accessibility	Changes the display font of the system and the voice guidance of the password.	—
	About device	Shows the status of the system, the Android version, the legal information, and so on.	—

Defaulting All the Settings

Reset all the menu and customized settings as the factory defaults.

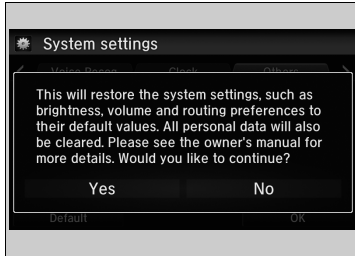

1. Press the  button.
2. Select **Settings**.
3. Select **System**.
4. Select the **Others** tab.
5. Select **Factory Data Reset**.
 - A confirmation message appears on the screen.
6. Select **Yes** to reset the settings.
7. Select **Yes** again to reset the settings.
 - A confirmation message appears on the screen. Select **OK**.

Defaulting All the Settings

When you transfer the vehicle to a third party, reset all settings to default and delete all personal data.

If you perform **Factory Data Reset**, it will reset the preinstalled apps to their factory default.

Hands-Free Telephone System*

Models with one display

The Hands-Free Telephone (HFT) System allows you to place and receive phone calls using your vehicle's audio system, without handling your mobile phone.

Using HFT

HFT Buttons

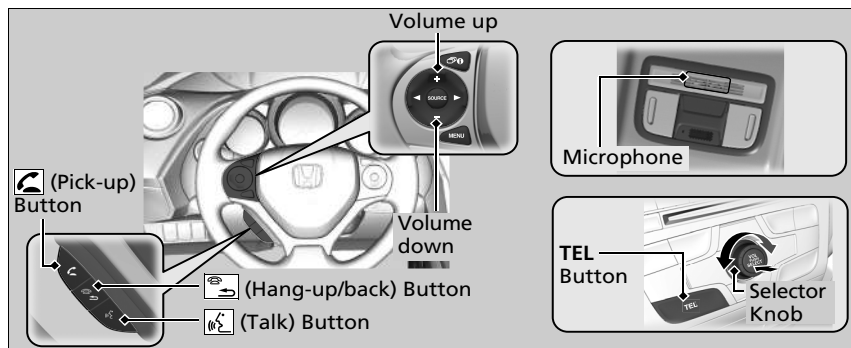



(Pick-up) button: Press to go directly to the **Phone** screen or to answer an incoming call.

(Hang-up/back) button: Press to end a call or cancel a command.

(Talk) button: Press to call a number with a stored voice tag.

TEL button: Press to go directly to the **Phone** screen.

Selector knob: Rotate  to select an item on the screen, then press .

Hands-Free Telephone System*

To use HFT, you need a *Bluetooth*-compatible mobile phone. For a list of compatible phones, pairing procedures, and special feature capabilities:

- Europe: Visit <http://www.hondahandsfree.com/>.
- Middle East: Visit <http://www.globalhondahandsfree.com/>.

Voice control tips

- Aim the vents away from the ceiling and close the windows, as noise coming from them may interfere with the microphone.
- Press and release the  (Talk) button when you want to call a number using a stored voice tag. Speak clearly and naturally after a beep.
- If the microphone picks up voices other than yours, the command may be misinterpreted.
- To change the volume level, use the audio system's volume knob or the remote audio controls on the steering wheel.

If you receive a call while using the audio system, the system resumes its operation after ending the call.

* Not available on all models

Continued

HFT Status Display

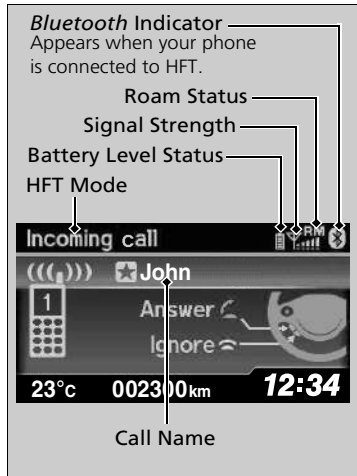

The i-multi-information display notifies you when there is an incoming call.

Limitations for Manual Operation

Certain manual functions are disabled or inoperable while the vehicle is in motion. You cannot select a grayed-out option until the vehicle is stopped.

Only previously stored speed dial entries with voice tags, phonebook names, or numbers can be called using voice commands while the vehicle is in motion.

▶ **Speed Dial** P. 344

▶▶ Hands-Free Telephone System *

Bluetooth® Wireless Technology

The *Bluetooth*® word mark and logos are registered trademarks owned by *Bluetooth* SIG, Inc., and any use of such marks by Honda Motor Co., Ltd., is under licence. Other trademarks and trade names are those of their respective owners.

HFT Limitations

An incoming call on HFT will interrupt the audio system when it is playing. It will resume when the call is ended.

European models

For information of DoC (Declaration of Conformance)

Hereby, Johnson Controls Automotive, declares that this Hands-Free Telephone System is in compliance with the essential requirements and other relevant provisions of Directive 1999/5/EC.

www.jciblueconnect.com/faq/EU_Doc.pdf

Except European models

For additional conformance information:

www.jciblueconnect.com/faq

▶▶ HFT Status Display

The information that appears on the i-multi-information display varies between phone models.

You can change the system language from English to other available one.

▶ **Customized Features** P. 131

HFT Menus

The ignition switch must be in ACCESSORY **I** or ON **II** to use HFT.

HFT Menu

To use HFT, you must first pair your *Bluetooth*-compatible mobile phone to the system while the vehicle is parked.

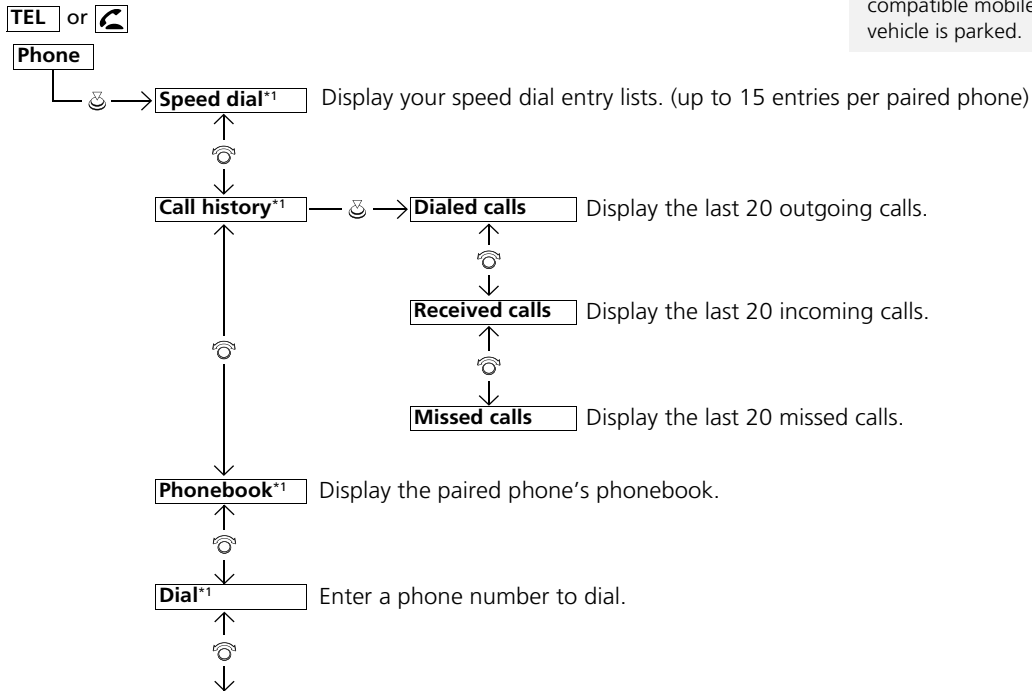

*1: Appears only when a phone is connected to HFT.

Continued

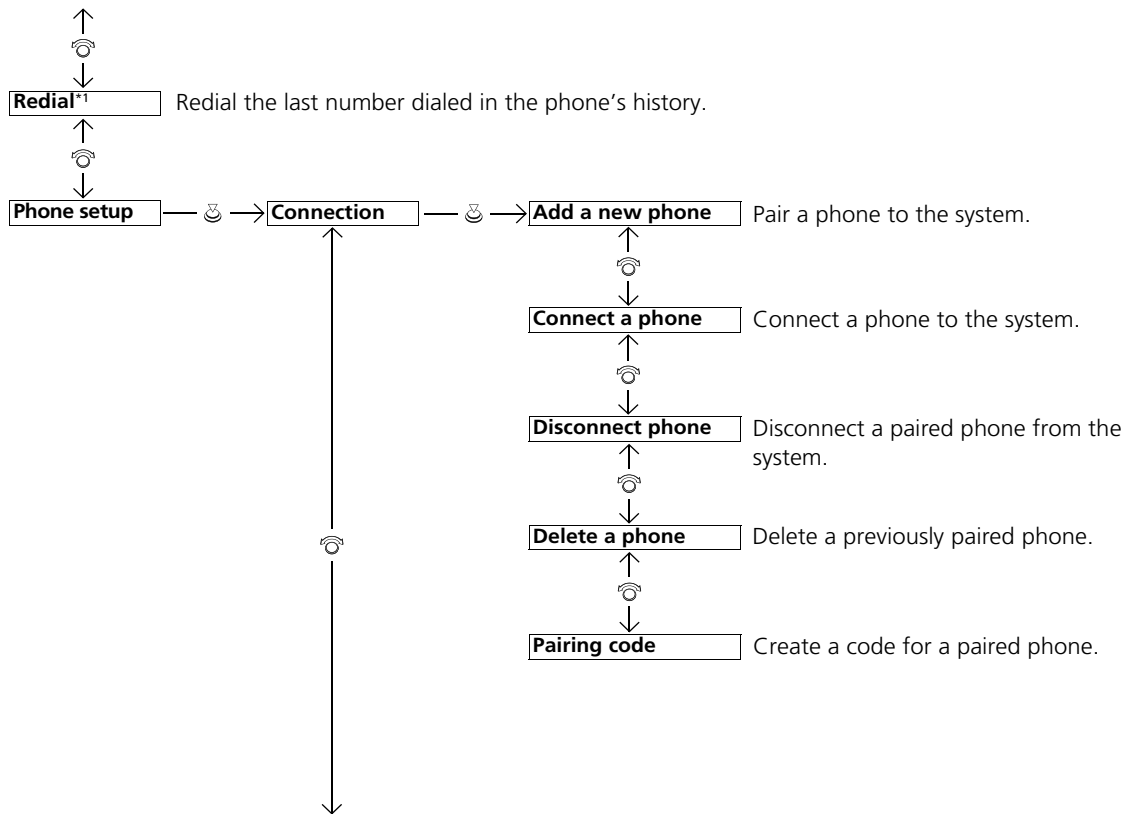

*1: Appears only when a phone is connected to HFT.

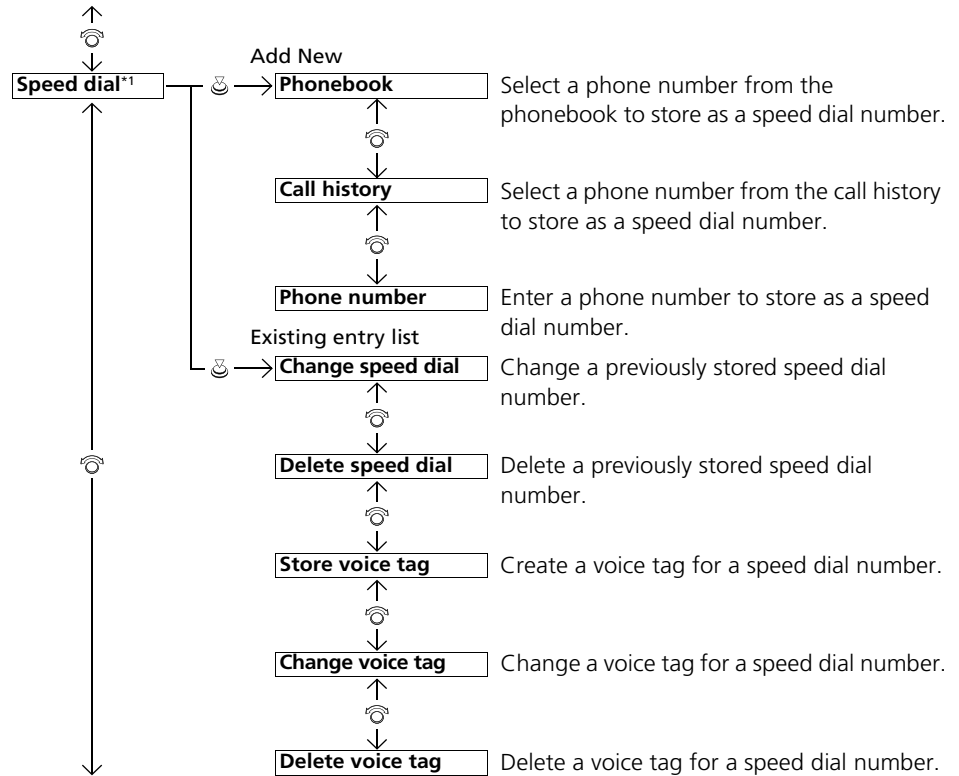

*1: Appears only when a phone is connected to HFT.

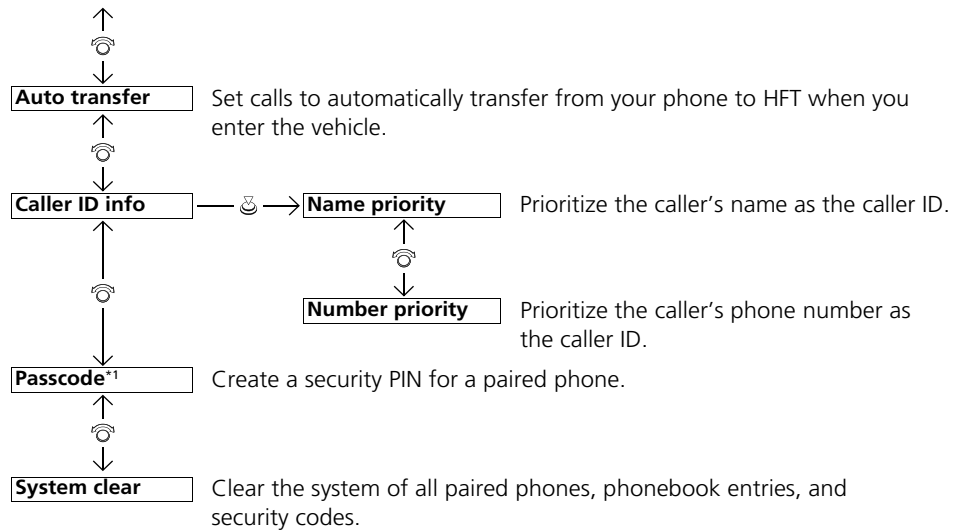



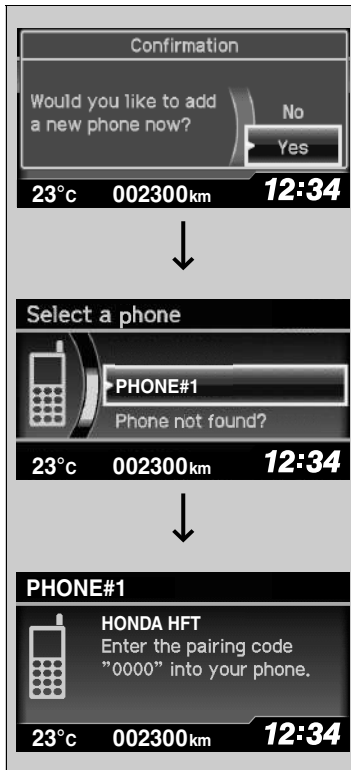

*1: Appears only when a phone is connected to HFT.

Phone Setup

To pair a mobile phone (No phone has been paired to the system)



1. Press the **TEL** button or the  button.
2. Rotate  to select **Yes**, then press .
3. Make sure your phone is in search or discoverable mode, then press .
 - ▶ HFT automatically searches for a *Bluetooth*® device.

4. When your phone appears on the list, select it by pressing .
 - ▶ If your phone doesn't appear, select **Phone not found?** and search for *Bluetooth*® devices using your phone. From your phone, select **HONDA HFT**.

5. HFT gives you a four-digit pairing code to input on your phone. When your phone prompts you, input the four-digit pairing code.
6. A notification appears on the screen if pairing is successful.

Phone Setup



Your *Bluetooth*-compatible phone must be paired to HFT before you can make and receive hands-free calls.

Phone Pairing Tips:

- You cannot pair your phone while the vehicle is moving.
- Up to six phones can be paired.
- Your phone's battery may drain faster when it is connected to HFT.
- If your phone is not ready for pairing or not found by the system within three minutes, the system will time out and return to idle.

Once you have paired a phone, you can see it displayed on the screen with one or two icons on the right side.







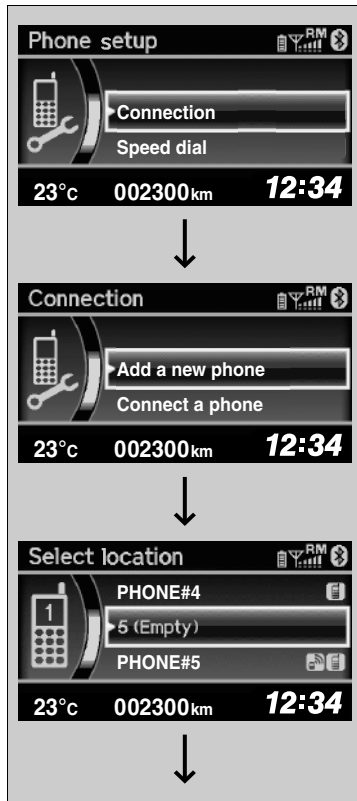

These icons indicate the following:

- : The phone can be used with HFT.
- : The phone is compatible with *Bluetooth*® Audio.

Continued

■ To pair a mobile phone (when a phone has already been paired to the system)



1. Press the **TEL** button or the  button.
 - ▶ If a prompt appears asking to connect to a phone, select **No** and proceed with step 2.
2. Rotate  to select **Phone setup**, then press .
3. Rotate  to select **Connection**, then press .
4. Rotate  to select **Add a new phone**, then press 
 - ▶ The screen changes to **Select location**.
5. Rotate  to select **Empty**, then press .

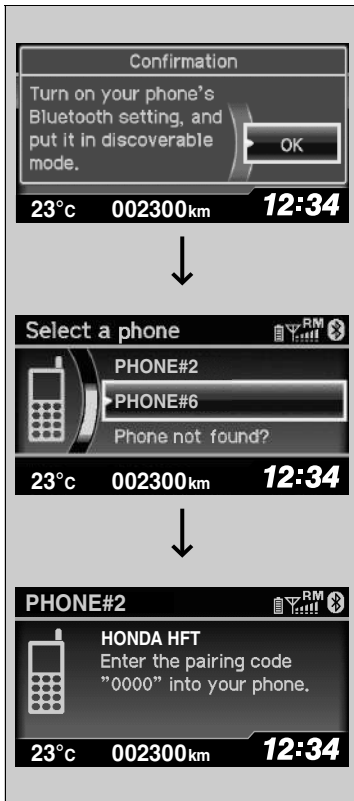

6. Make sure your phone is in search or discoverable mode, then press .
 - ▶ HFT automatically searches for a *Bluetooth*[®] device.

7. When your phone appears on the list, select it by pressing .
 - ▶ If your phone doesn't appear, select **Phone not found?** and search for *Bluetooth*[®] devices using your phone. From your phone, select **HONDA HFT**.

8. HFT gives you a four-digit pairing code to input on your phone. When your phone prompts you, input the four-digit pairing code.
9. A notification appears on the screen if pairing is successful.

Continued

■ To change the pairing code setting

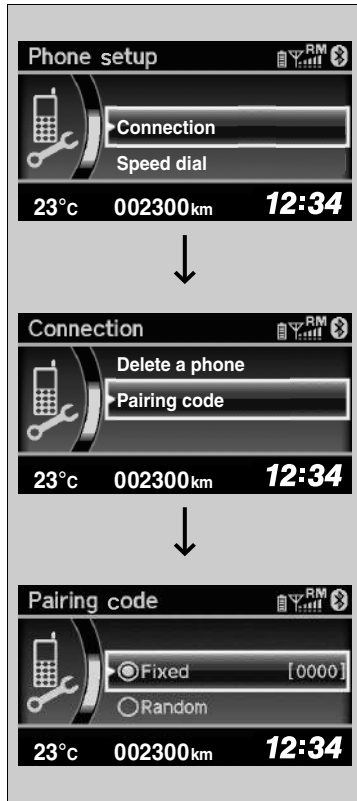

1. Press the **TEL** button or the button.
▶ Rotate to select **Phone setup**, then press .
2. Rotate to select **Connection**, then press .
3. Rotate to select **Pairing code**, then press .
4. Rotate to select **Fixed** or **Random**, then press .

▣ To change the pairing code setting





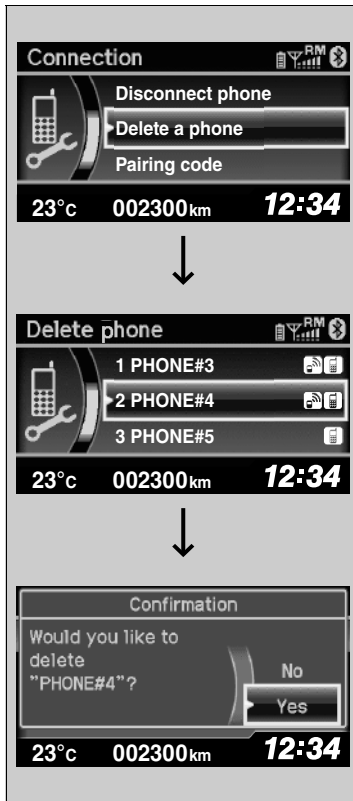

The default pairing code is **0000** until you change the setting.

To create your own, select **Fixed**, and delete the current code, then enter a new one.

For a randomly generated pairing code each time you pair a phone, select **Random**.

■ To delete a paired phone



1. Press the **TEL** button or the  button.
2. Rotate  to select **Phone setup**, then press .
 - ▶ Repeat the procedure to select **Connection**, then **Delete a phone**.
3. Rotate  to select a phone you want to delete, then press .
4. A confirmation message appears on the screen. Rotate  to select **Yes**, then press .
 - ▶ A notification appears if the deletion is successful.

Continued

■ To Create a Security PIN

You can protect each of the six mobile phones with a security PIN.

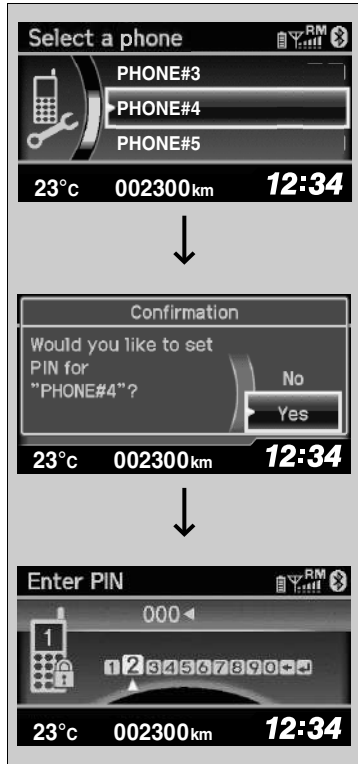

1. Press the **TEL** button or the button.
2. Rotate to select **Phone setup**, then press .
 - ▶ Repeat the procedure to select **Passcode**.
3. Select a phone you want to add a security PIN to.
 - ▶ Rotate to select a phone you want to add a security PIN to, then press .
4. A confirmation message appears on the screen.
 - ▶ Rotate to select **Yes**, then press .
5. Enter a new four-digit number.
 - ▶ Rotate to select, then press . Press to delete. Press to enter the security PIN.
6. Re-enter the four-digit number.
 - ▶ The screen returns to the screen in step 2.

▣ To Create a Security PIN

If the phone is already security PIN protected, you need to enter the current security PIN before clearing the PIN or creating a new one.

Automatic Transferring

If you get into the vehicle while you are on the phone, the call can be automatically transferred to HFT.

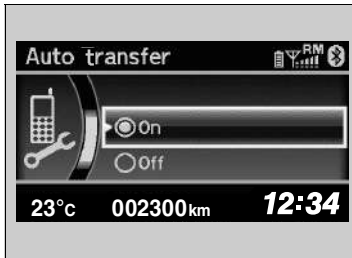

1. Press the **TEL** button or the button.
2. Rotate to select **Phone setup**, then press .
- ▶ Repeat the procedure to select **Auto transfer**.
3. Rotate to select **On**, then press .
4. A notification appears on the screen if the change is successful.

Caller's ID Information

You can select a caller's information to be displayed when you have an incoming call.



1. Press the **TEL** button or the button.
2. Rotate to select **Phone setup**, then press .
- ▶ Repeat the procedure to select **Caller ID info**.
3. Rotate to select a mode you want, then press .
4. A notification appears on the screen if the change is successful.

☒ Caller's ID Information

Name priority mode: A caller's name is displayed if it is stored in the phonebook.

Number priority mode: A caller's phone number is displayed.

■ To Clear the System

Security codes, paired phones, all stored voice tag, all speed dial entries, and all imported phonebook data are erased.

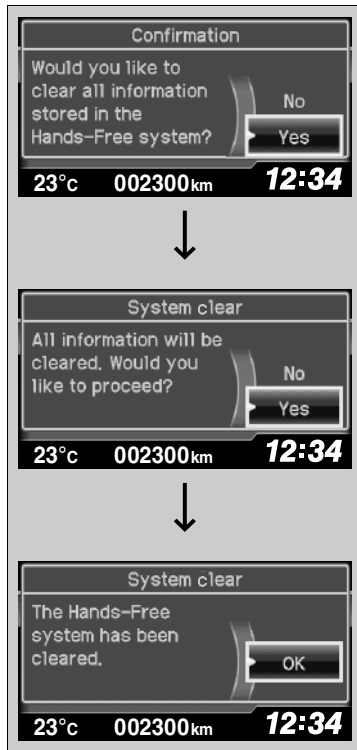

1. Press the **TEL** button or the button.
2. Rotate to select **Phone setup**, then press .
 - ▶ Repeat the procedure to select **System clear**.
3. Rotate to select **Yes**, then press .
4. A confirmation message appears on the screen. Rotate to select **Yes**, then press .
5. A confirmation message appears on the screen. Press to finish.

Automatic Import of Mobile Phonebook and Call History

When your phone is paired, the contents of its phonebook and call history are automatically imported to HFT.



Automatic Import of Mobile Phonebook and Call History

When you select a person from the list in the mobile phonebook, you can see up to three category icons. The icons indicate what types of numbers are stored for that name.



If a name has four or more numbers, ... appears instead of category icons.

On some phones, it may not be possible to import the category icons to HFT.

The phonebook is updated after every connection. Call history is updated after every connection or call.

Continued

Speed Dial

Up to 15 speed dial numbers can be stored per phone.



To store a speed dial number:

1. Press the **TEL** button or the button.
2. Rotate to select **Phone setup**, then press .
 - ▶ Repeat the procedure to select **Speed dial**, then **Add new**.
3. Rotate to select a place to choose a number from, then press .
 - By **Phonebook**:
 - ▶ Select a number from the connected mobile phone's imported phonebook.
 - By **Call history**:
 - ▶ Select a number from the call history.
 - By **Phone number**:
 - ▶ Input the number manually.
4. When the speed dial is successfully stored, you are asked to create a voice tag for the number. Rotate to select **Yes** or **No**, then press .
5. Using the button, follow the prompts to say the name for the speed dial entry.

Speed Dial

You can use the audio preset buttons during a call to store a speed dial number:

1. Press and hold the desired audio preset button during a call.
2. The contact information for the active call will be stored for the corresponding speed dial.

When a voice tag is stored, press the button to call the number using the voice tag.

■ To add a voice tag to a stored speed dial number



1. Press the **TEL** button or the button.
2. Rotate to select **Phone setup**, then press .
- ▶ Repeat the procedure to select **Speed dial**.
3. Select an existing speed dial entry.
4. Rotate to select **Store voice tag**, then press .
5. Using the button, follow the prompts to complete the voice tag.





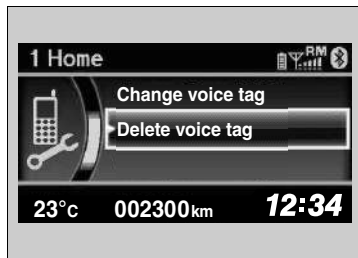

☒ Speed Dial

Avoid using duplicate voice tags.
 Avoid using "home" as a voice tag.
 It is easier for HFT to recognise a longer name. For example, use "John Smith" instead of "John."

Continued







■ To delete a voice tag

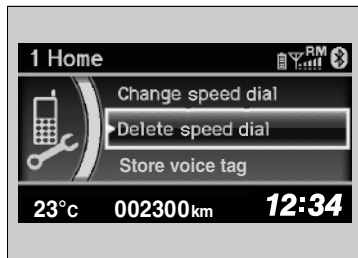

1. Press the **TEL** button or the  button.
2. Rotate  to select **Phone setup**, then press .
 - ▶ Repeat the procedure to select **Speed dial**.
3. Select an existing speed dial entry.
4. Rotate  to select **Delete voice tag**, then press .
 - ▶ A confirmation message appears on the screen. Rotate  to select **Yes**, then press .

■ To delete a speed dial number



1. Press the **TEL** button or the  button.
2. Rotate  to select **Phone setup**, then press .
 - ▶ Repeat the procedure to select **Speed dial**.
3. Select an existing speed dial entry.
4. Rotate  to select **Delete speed dial**, then press .
 - ▶ A confirmation message appears on the screen. Rotate  to select **Yes**, then press .

■ Making a Call

You can make calls by inputting any phone number, or by using the imported phonebook, call history, speed dial entries, or redial.



▣ Making a Call

Once a call is connected, you can hear the voice of the person you are calling through the audio speakers.

Any voice-tagged speed dial entry can be dialed by voice from any screen.

Press the  button and follow the prompts.

Continued

■ To make a call using the imported phonebook



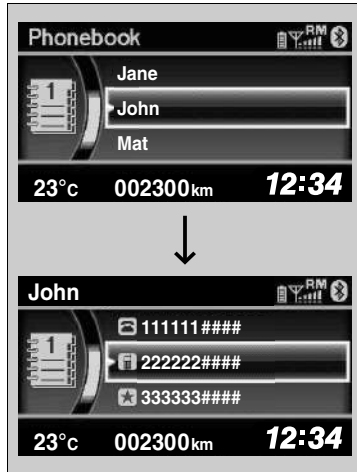





When your phone is paired, the contents of its phonebook are automatically imported to HFT.



1. Press the **TEL** button or the button.
 2. Rotate to select **Phonebook**, then press .
 3. The phonebook is stored alphabetically. Rotate to select the initial, then press .
 4. Rotate to select a name, then press .
 5. Rotate to select a number, then press .
- ▶ Dialing starts automatically.



■ To make a call using a phone number

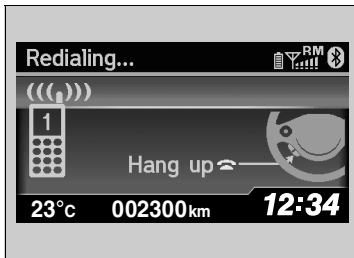

1. Press the **TEL** button or the  button.
2. Rotate  to select **Dial**, then press .
3. Rotate  to select a number, then press .
4. Rotate  to select , then press .
 - ▶ Dialing starts automatically.

■ To make a call using redial



1. Press the **TEL** button or the  button.
2. Rotate  to select **Redial**, then press .
 - ▶ Dialing starts automatically.

■ To make a call using the call history

Call history is stored by **Dialed calls**, **Received calls**, and **Missed calls**.

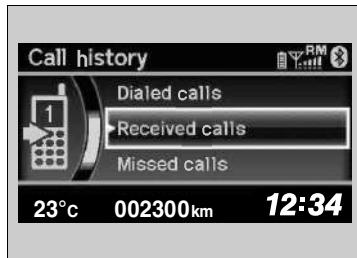

1. Press the **TEL** button or the button.
2. Rotate to select **Call history**, then press .
3. Rotate to select **Dialed calls**, **Received calls**, or **Missed calls**, then press .
4. Rotate to select a number, then press .
 - ▶ Dialing starts automatically.

■ To make a call using a speed dial entry

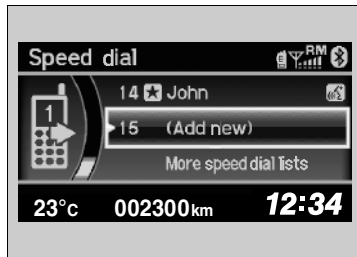

1. Press the **TEL** button or the button.
2. Rotate to select **Speed dial**, then press .
3. Rotate to select a number, then press .
 - ▶ Dialing starts automatically.

▶▶ To make a call using the call history

The call history appears only when a phone is connected to HFT, and displays the last 20 dialed, received, or missed calls.

▶▶ To make a call using a speed dial entry

On the **Phone** screen, the first six speed dials on the list can be directly selected by pressing the corresponding audio preset buttons (1-6).

Select **More speed dial lists** to view another paired phone's speed dial list. You can make a call from that list using the currently connected phone.

Any voice-tagged speed dial entry can be dialed by voice from any screen. Press the button and follow the prompts.

Receiving a Call



When there is an incoming call, an audible notification sounds (if activated) and the **Incoming call** screen appears.

Press the  button to answer the call.

Press the  button to decline or end the call.

Receiving a Call

Call Waiting

Press the  button to put the current call on hold to answer the incoming call.

Press the  button again to return to the current call.

Ignore the incoming call if you do not want to answer it.

Press the  button if you want to hang up the current call.

Continued

■ Options During a Call

The following options are available during a call.



Mute: Mute your voice.

Transfer call: Transfer a call from HFT to your phone.

Touch tones: Send numbers during a call. This is useful when you call an automated phone system.



1. To view the available options, press the **TEL** button.

2. Rotate  to select the option, then press .

▶ The check box is checked when **Mute** is selected. Select **Mute** again to turn it off.

☒ Options During a Call

Touch tones: Available on some phones.

Hands-Free Telephone System

Models with two displays

The Hands-Free Telephone (HFT) System allows you to place and receive phone calls using your vehicle's audio system, without handling your mobile phone.

Using HFT

HFT Buttons

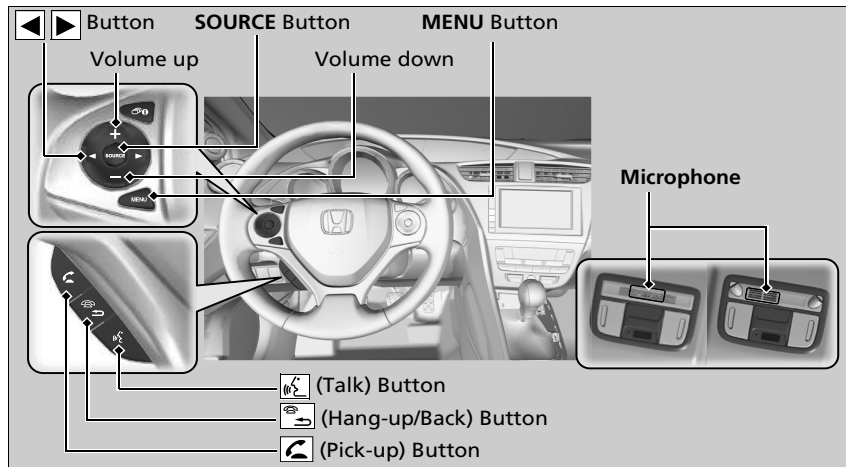

Hands-Free Telephone System

To use HFT, you need a *Bluetooth*-compatible mobile phone. For a list of compatible phones, pairing procedures, and special feature capabilities, ask a dealer or your local Honda.

To use the system, the **Bluetooth On/Off Status** setting must be **On**.

➤ **Customized Features** P. 313

Voice control tips

- Aim the vents away from the ceiling and close the windows, as noise coming from them may interfere with the microphones.
- Press the  button when you want to call a number using a stored voice tag. Speak clearly and naturally after a beep.
- If the microphones pick up voices other than yours, the command may be misinterpreted.
- To change the volume level, select the audio system's **VOL** (Volume) or use the remote audio controls on the steering wheel.

Up to five speed dial entries can be displayed among a total of 20 that can be entered. If there is no entry in the system, Speed Dial is disabled.

➤ **Speed Dial** P. 365

Up to five call histories can be displayed among a total of 20 that can be entered. If there is no call history, Call History is disabled.

Continued

 **(Pick-up) button:** Press to go directly to the phone screen, or to answer an incoming call.

 **(Hang-up/back) button:** Press to end a call, go back to the previous command, or cancel a command.



 **(Talk) button:** Press to call a number with a stored voice tag.

MENU button: Press and hold to display **Speed Dial**, **Call History**, or **Redial** on the phone screen.

 **button:** Press to select an item displayed on the phone screen.

SOURCE button: Press to call a number listed in the selected item on the phone screen.

To go to the **Phone Menu** screen:

1. Press the  button.
2. Select **Phone** to switch the display to the phone screen.
3. Press the  button.

Hands-Free Telephone System

Bluetooth[®] Wireless Technology

The *Bluetooth*[®] word mark and logos are registered trademarks owned by *Bluetooth* SIG, Inc., and any use of such marks by Honda Motor Co., Ltd., is under licence. Other trademarks and trade names are those of their respective owners.

HFT Limitations

An incoming call on HFT will interrupt the audio system when it is playing. It will resume when the call is ended.

■ HFT Status Display

The audio/information screen notifies you when there is an incoming call.

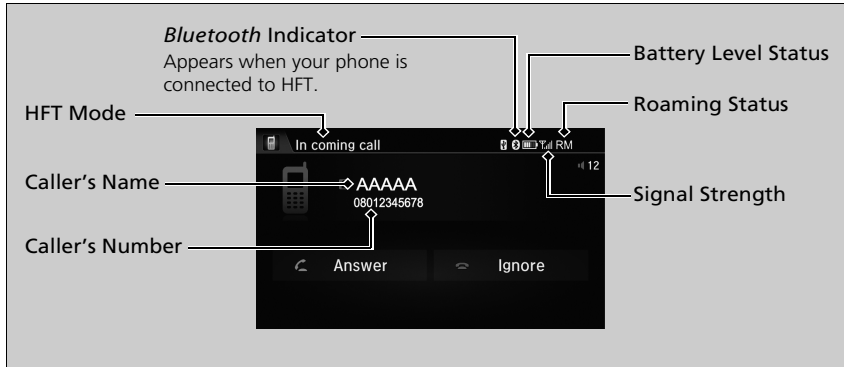

■ Limitations for Manual Operation

Certain manual functions are disabled or inoperable while the vehicle is in motion. You cannot select a grayed-out option until the vehicle is stopped.

Only previously stored speed dial entries with voice tags, phonebook names, or numbers can be called using voice commands while the vehicle is in motion.

▶ **Speed Dial** P. 365

▶ HFT Status Display

The information that appears on the audio/information screen varies between phone models.

You can change the system language.

▶ **Customized Features** P. 313

HFT Menu

The ignition switch must be in ACCESSORY  or ON *1 to use the system.

HFT Menu

To use HFT, you must first pair your *Bluetooth*-compatible mobile phone to the system while the vehicle is parked.

Some functions are limited while driving.

Phone settings screen

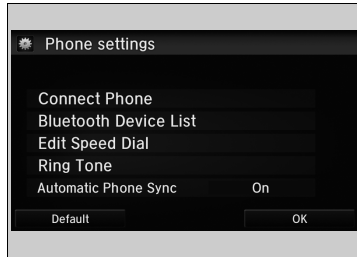

1. Press the  button.
2. Select **Settings**.
3. Select **Phone**.

Features

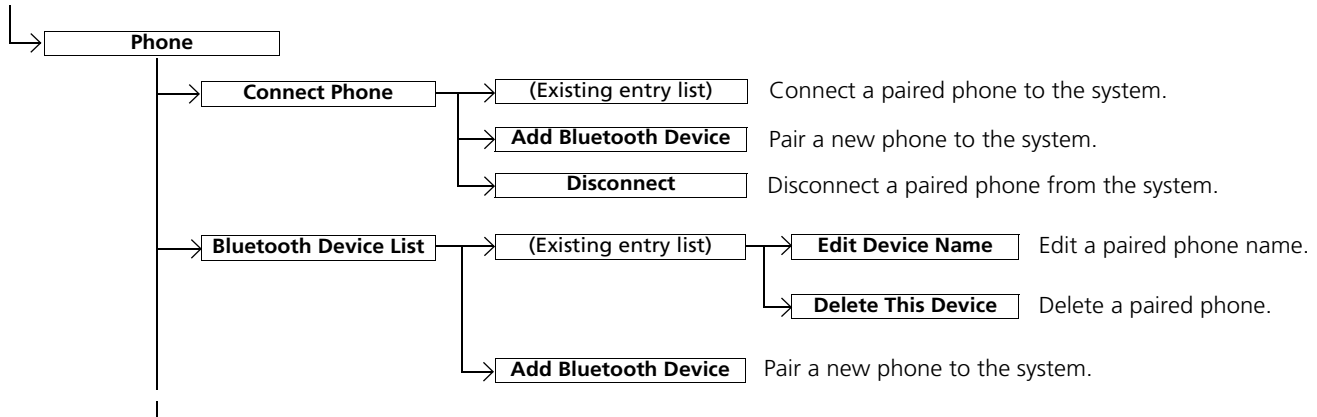

*1: Models with the keyless access system have an **ENGINE START/STOP** button instead of an ignition switch.

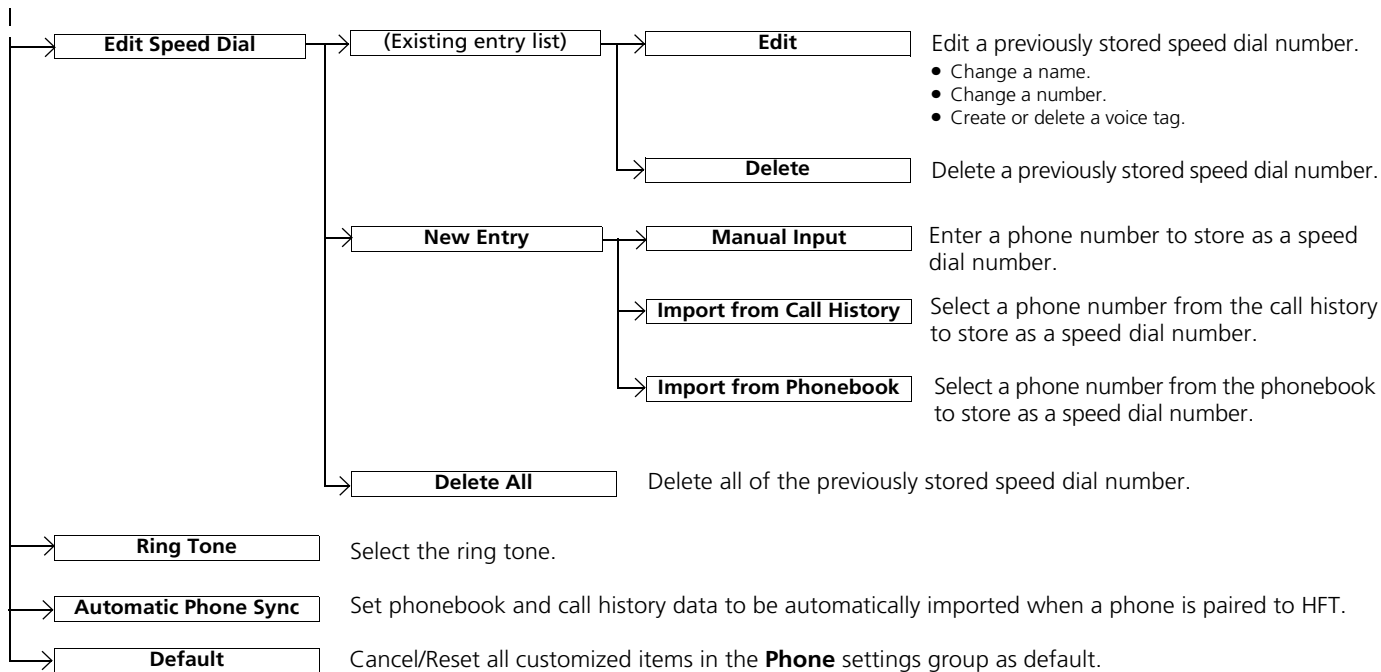

■ Phone Menu screen

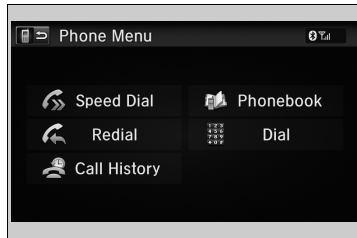

1. Press the  button.
2. Select **Phone**.
3. Press the  button.

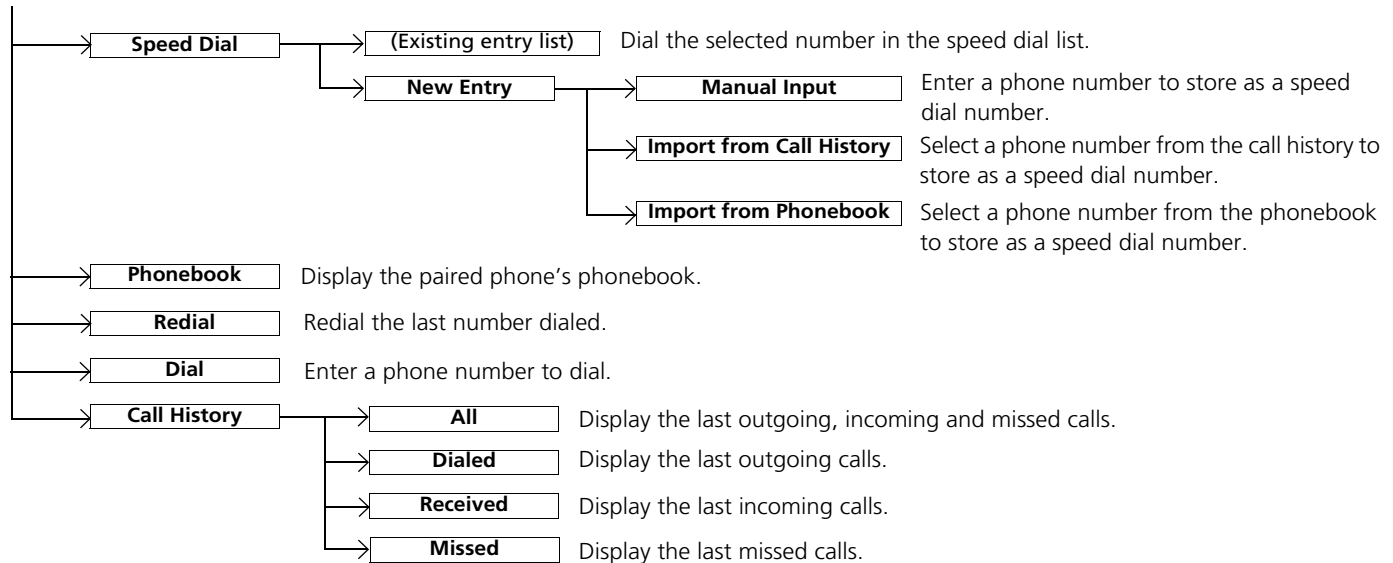

Phone Setup

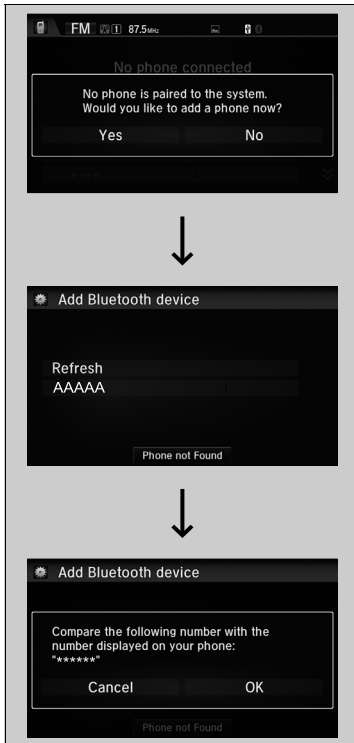

■ To pair a mobile phone (when there is no phone paired to the system)

1. Select **Phone**.
2. Select **Yes**.
3. Make sure your phone is search or discoverable mode, then select **Continue**.
 - ▶ HFT automatically searches for a *Bluetooth*® device.
4. Select your phone when it appears on the list.
 - ▶ If your phone does not appear, you can select **Refresh** to search again.
 - ▶ If your phone still does not appear, select **Phone not Found** and search for *Bluetooth*® devices using your phone. From your phone, search for **Honda HFT**.
5. The system gives you a pairing code on the audio/information screen.
 - ▶ Confirm if the pairing code on the screen and your phone match. This may vary by phone.

☒ Phone Setup

Your *Bluetooth*-compatible phone must be paired to the system before you can make and receive hands-free calls.

Phone Pairing Tips:

- You cannot pair your phone while the vehicle is moving.
- Up to six phones can be paired.
- Your phone's battery may drain faster when it is paired to the system.
- If your phone is not ready for pairing or not found by the system within three minutes, the system will time out and return to idle.

Continued

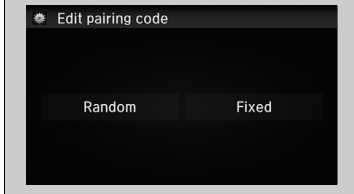
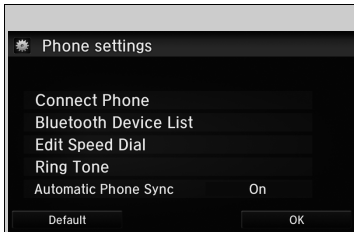

■ To change the currently paired phone

1. Go to the phone settings screen.
 - ▶ **Phone settings screen** P. 356
2. Select **Connect Phone**.
3. Select a phone to connect.
 - ▶ HFT disconnects the connected phone and starts searching for another paired phone.

■ To change the pairing code setting

1. Press the  button.
2. Select **Settings**.
3. Select **Bluetooth / Wi-Fi**.
4. Select the **Bluetooth** tab.
5. Select **Edit Pairing Code**.
6. Select **Random** or **Fixed**.

▶▶ To change the currently paired phone

If no other phones are found or paired when trying to switch to another phone, HFT will inform you that the original phone is connected again.

To pair other phones, select **Add Bluetooth Device** from the **Connect Phone** screen.

▶▶ To change the pairing code setting

The default pairing code is **0000** until you change the setting.
To create your own, select **Fixed**, and delete the current code, then enter a new one.

For a randomly generated pairing code each time you pair a phone, select **Random**.

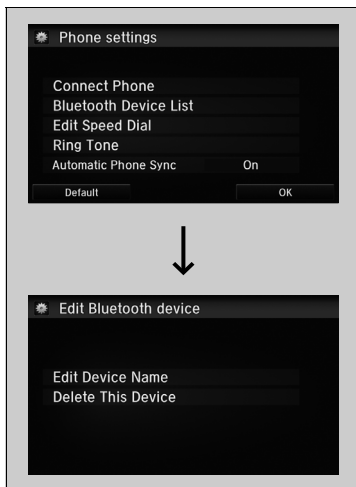

■ To edit an already-paired phone name

1. Go to the phone settings screen.
 - ▶ **Phone settings screen** P. 356
2. Select **Bluetooth Device List**.
3. Select a paired phone you want to edit.
4. Select **Edit Device Name**.
5. Edit the name and select **OK**.

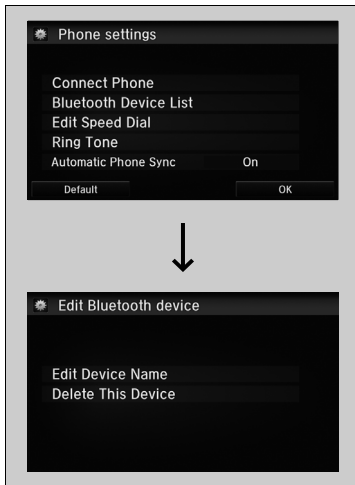

■ **To delete a paired phone**

1. Go to the phone settings screen.
 - ▶ **Phone settings screen** P. 356
2. Select **Bluetooth device list**.
3. Select a phone you want to delete.
4. Select **Delete This Device**.
5. A confirmation message appears on the screen. Select **Yes**.

Ring Tone

You can change the ring tone setting.

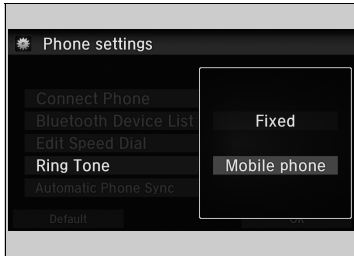

1. Go to the phone settings screen.
 ▶ **Phone settings screen** P. 356
2. Select **Ring Tone**.
3. Select **Fixed** or **Mobile phone**.

Ring Tone

Fixed: The fixed ring tone sounds from the speakers.

Mobile phone: The ring tone stored in the connected mobile phone sounds from the speakers.

Continued

Automatic Import of Cellular Phonebook and Call History

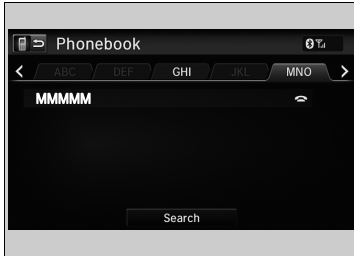

■ When Automatic Phone Sync is set to On:

When your phone is paired, the contents of its phonebook and call history are automatically imported to the system.

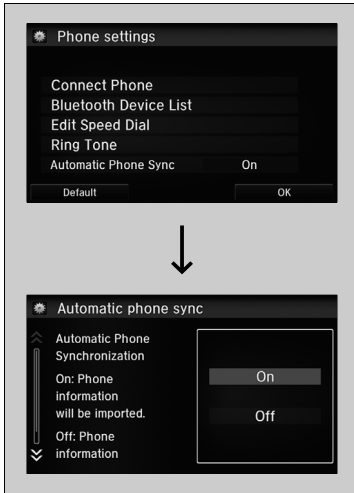

■ Changing the Automatic Phone Sync setting

1. Go to the phone settings screen.
 - ▶ **Phone settings screen** P. 356
2. Select **Automatic Phone Sync**.
3. Select **On** or **Off**.

▶ Automatic Import of Cellular Phonebook and Call History

When you select a name from the list in the cellular phonebook, you can see up to three category icons. The icons indicate what types of numbers are stored for that name.

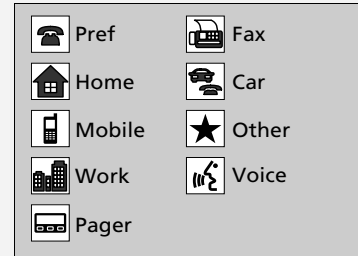

On some phones, it may not be possible to import the category icons to the system.

The phonebook is updated after every connection. Call history is updated after every connection or call.

Speed Dial

Up to 20 speed dial numbers can be stored per phone.

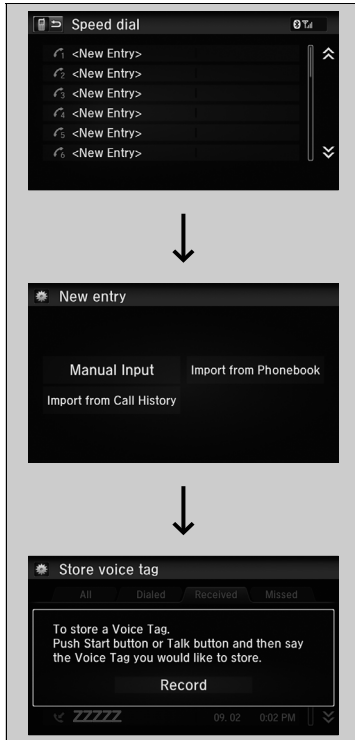

To store a speed dial number:

1. Go to the **Phone Menu** screen.

▶ **Phone Menu screen P. 358**

2. Select **Speed Dial**.

3. Select **New Entry**.

4. Select a place to choose a number.

From **Import from Call History**:

▶ Select a number from the call history.

From **Manual Input**:

▶ Input the number manually.

From **Import from Phonebook**:

▶ Select a number from the connected mobile phone's imported phonebook.

5. When the speed dial is successfully stored, you are asked to create a voice tag for the number. Select **Yes** or **No**.

6. Select **Record** to store a voice tag for the speed dial entry.

▶ Using the  button, follow the prompts to store a voice tag for the speed dial entry.

Speed Dial

When a voice tag is stored, press the  button to call the number using the voice tag. Say the voice tag name.

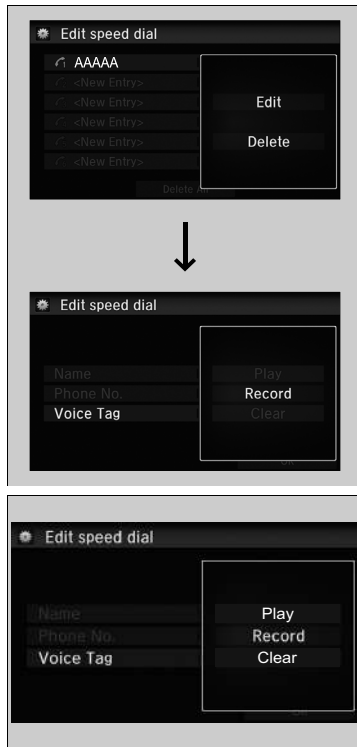

■ **To add a voice tag to a stored speed dial number**

1. Go to the phone settings screen.
 - ▶ **Phone settings screen** P. 356
2. Select **Edit Speed Dial**.
3. Select an existing speed dial entry.
 - ▶ From the pop-up menu, select **Edit**.
4. Select **Voice Tag**.
 - ▶ From the pop-up menu, select **Record**.
5. Select **Record** to store the voice tag.
6. Using the  button, follow the prompts to complete the voice tag.

■ **To delete a voice tag**

1. Go to the phone settings screen.
 - ▶ **Phone settings screen** P. 356
2. Select **Edit Speed Dial**.
3. Select an existing speed dial entry.
 - ▶ From the pop-up menu, select **Edit**.
4. Select **Voice Tag**.
 - ▶ From the pop-up menu, select **Clear**.
5. A confirmation message appears on the screen. Select **Yes**.

▶▶ Speed Dial

Avoid using duplicate voice tags.
 Avoid using "home" as a voice tag.
 It is easier for the system to recognise a longer name.
 For example, use "John Smith" instead of "John."

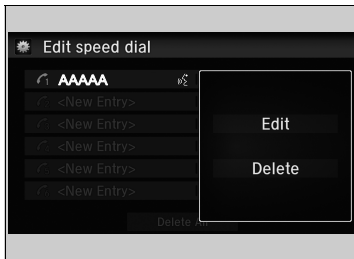

■ To edit a speed dial

1. Go to the phone settings screen.
▶ **Phone settings screen** P. 356
2. Select **Edit Speed Dial**.
3. Select an existing speed dial entry.
▶ From the pop-up menu, select **Edit**.
4. Select a setting you want.

■ To delete a speed dial

1. Go to the phone settings screen.
▶ **Phone settings screen** P. 356
2. Select **Edit Speed Dial**.
3. Select an existing speed dial entry.
▶ From the pop-up menu, select **Delete**.
4. A confirmation message appears on the screen. Select **Yes**.

■ Making a Call

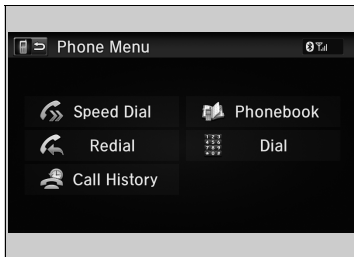

You can make calls by inputting any phone number, or by using the imported phonebook, call history, speed dial entries, or redial.

▶▶ Making a Call

Any voice-tagged speed dial entry can be dialed by voice from most screens.

Press the  button and say the voice tag name.

Once a call is connected, you can hear the voice of the person you are calling through the audio speakers.

Continued

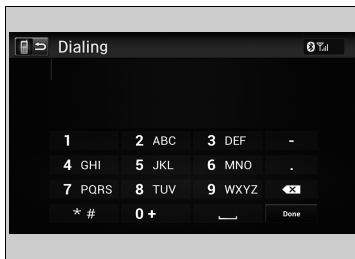

■ **To make a call using the imported phonebook**

1. Go to the **Phone Menu** screen.
 - ▶ **Phone Menu** screen P. 358
2. Select **Phonebook**.
3. Select a name.
 - ▶ You can also search by letter. Select **Search**.
 - ▶ Use the keyboard on the touch screen for entering letters.
4. Select a number.
 - ▶ Dialing starts automatically.

■ **To make a call using a phone number**

1. Go to the **Phone Menu** screen.
 - ▶ **Phone Menu** screen P. 358
2. Select **Dial**.
3. Select a number.
 - ▶ Use the keyboard on the touch screen for entering numbers.
4. Select **Done**.
 - ▶ Dialing starts automatically.

▶▶ To make a call using the imported phonebook

You can call a stored voice-tagged speed dial number using voice commands.

▶ **Speed Dial** P. 365

▶▶ To make a call using a phone number

You can call a stored voice-tagged speed dial number using voice commands.

▶ **Speed Dial** P. 365

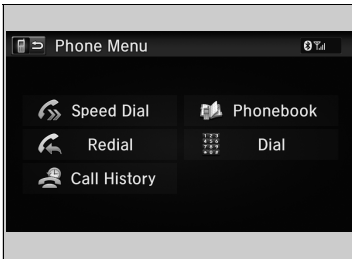

■ **To make a call using redial**

1. Go to the **Phone Menu** screen.
 ▶ **Phone Menu screen** P. 358
2. Select **Redial**.
 ▶ Dialing starts automatically.

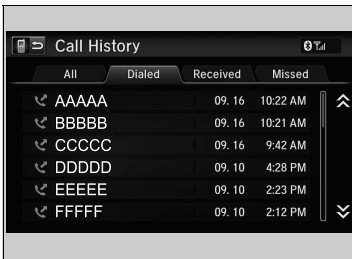

■ **To make a call using the Call History**

Call history is stored by **All, Dialed, Received, and Missed**.

1. Go to the **Phone Menu** screen.
 ▶ **Phone Menu screen** P. 358
2. Select **Call History**.
3. Select **All, Dialed, Received, or Missed**.
4. Select a number.
 ▶ Dialing starts automatically.

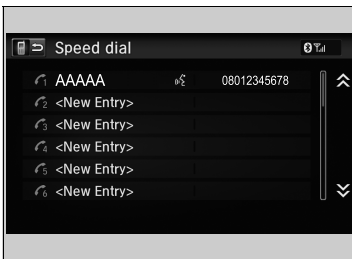

■ **To make a call using a Speed Dial entry**

1. Go to the **Phone Menu** screen.
 ▶ **Phone Menu screen** P. 358
2. Select **Speed Dial**.
3. Select a number.
 ▶ Dialing starts automatically.

☒ **To make a call using redial**

Press and hold the button to redial the last number dialed.

☒ **To make a call using the Call History**

The call history displays the last 20 all, dialed, received, or missed calls.
 (Appears only when a phone is connected to the system.)

☒ **To make a call using a Speed Dial entry**

When a voice tag is stored, press the button to call the number using the voice tag.

▶ **Speed Dial** P. 365



Any voice-tagged speed dial entry can be dialed by voice from any screen.
 Press the button and follow the prompts.

Continued

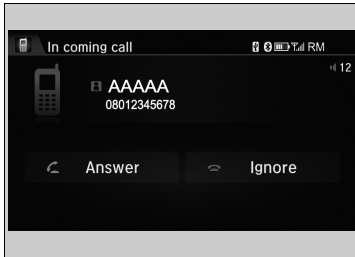
Receiving a Call



When there is an incoming call, an audible notification sounds (if activated) and the **Incoming call** screen appears.

Press the  button to answer the call.
Press the  button to decline or end the call.

Options During a Call

The following options are available during a call.

Mute: Mute your voice.

Transfer: Transfer a call from the system to your phone.

Touch Tones: Send numbers during a call. This is useful when you call a menu-driven phone system.

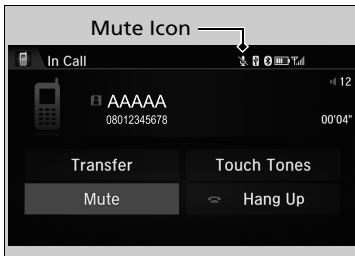

The available options are shown on the lower half of the screen.

Select the option.

- ▶ The mute icon appears when **Mute** is selected. Select **Mute** again to turn it off.

Receiving a Call



Call Waiting

Press the  button to put the current call on hold to answer the incoming call.

Press the  button again to return to the current call.

Select **Ignore** to ignore the incoming call if you do not want to answer it.

Press the  button if you want to hang up the current call.

You can select the icons on the audio/information screen instead of the  and  buttons.

Options During a Call

Touch Tones: Available on some phones.

You can select the icons on the audio/information screen.

Driving



This chapter discusses driving, refueling, and information on items such as accessories.

Before Driving			
Driving Preparation	372		
Load Limit	375		
Towing a Trailer*			
Towing Preparation	376		
Driving Safely with a Trailer	379		
When Driving			
Models without keyless access system			
Starting the Engine	382		
Models with keyless access system			
Starting the Engine	385		
Precautions While Driving	388		
Automatic Transmission*	389		
Automatic transmission models			
Shifting	390		
Manual transmission models			
Shifting	395		
Auto Idle Stop	398		
ECON Button*	402		
+R Button*	403		
Cruise Control*	404		
Adjustable Speed Limiter*	407		
Forward Collision Warning*	411		
Lane Departure Warning*	415		
Traffic Sign Recognition System*	418		
Vehicle Stability Assist (VSA) System	422		
Agile Handling Assist System	424		
Blind Spot Information System*	425		
Deflation Warning System	428		
Braking			
Brake System	430		
Anti-lock Brake System (ABS)	432		
Brake Assist System	433		
City-Brake Active system*	434		
Emergency Stop Signal	439		
Parking Your Vehicle			
When Stopped	440		
Parking Sensor System*	441		
Cross Traffic Monitor*	446		
Rearview Camera*	451		
Refueling			
Petrol models			
Fuel Information	452		
Diesel models			
Fuel Information	453		
Petrol models			
How to Refuel	454		
Diesel models			
How to Refuel	455		
Fuel Economy and CO₂ Emissions	456		
Accessories and Modifications	457		

* Not available on all models

Driving Preparation

Check the following items before you start driving.

Exterior Checks

- Make sure there are no obstructions on the windows, door mirrors, exterior lights, or other parts of the vehicle.
 - ▶ Remove any frost, snow, or ice.
 - ▶ Remove any snow on the roof, as this can slip down and obstruct your field of vision while driving. If frozen solid, remove ice once it has softened.
 - ▶ When removing ice from around the wheels, be sure not to damage the wheel or wheel components.
- Make sure the bonnet is securely closed.
 - ▶ If the bonnet opens while driving, your front view will be blocked.
- Make sure the tyres are in good condition.
 - ▶ Check air pressures, and check for damage and excessive wear.
 - 📄 **Checking and Maintaining Tyres** P. 534
- Make sure there are no people or objects behind or around the vehicle.
 - ▶ There are blind spots from the inside.

Exterior Checks

NOTICE

When doors are frozen shut, use warm water around the door edges to melt any ice. Do not try to force them open, as this can damage the rubber trim around the doors. When done, wipe dry to avoid further freezing.

Do not pour warm water into the key cylinder. You will be unable to insert the key if the water freezes in the hole.

Heat from the engine and exhaust can ignite flammable materials left under the bonnet, causing a fire. If you've parked your vehicle for an extended period, inspect and remove any debris that may have collected, such as dried grass and leaves that have fallen or have been carried in for use as a nest by a small animal. Also check under the bonnet for leftover flammable materials after you or someone else has performed maintenance on your vehicle.

Interior Checks

- Store or secure all items on board properly.
 - ▶ Carrying too much luggage, or improperly storing it, can affect your vehicle's handling, stability, stopping distance, and tyres, and make it unsafe.
 - ✦ **Load Limit** P. 375
- Do not pile items higher than the seat height.
 - ▶ They can block your view and may be thrown forward in the event of sudden braking.
- Do not place anything in the front seat footwells. Make sure to secure the floor mat*.
 - ▶ An object or unsecured floor mat can interfere with your brake and accelerator pedal operation while driving.
- If you have any animals on board, do not let them move around in the vehicle.
 - ▶ They may interfere with driving and a crash could occur.
- Securely close and lock all doors and the tailgate.
- Adjust your seating position properly.
 - ▶ Adjust the head restraint, too.
 - ✦ **Adjusting the Seats** P. 193
 - ✦ **Adjusting the Head Restraints*** P. 196
- Adjust the mirrors and steering wheel properly for your driving.
 - ▶ Adjust them while sitting in the proper driving position.
 - ✦ **Adjusting the Mirrors** P. 190
 - ✦ **Adjusting the Steering Wheel** P. 189

Interior Checks

The headlight aim is set by the factory, and does not need to be adjusted. However, if you regularly carry heavy items in the luggage area or tow a trailer, have the aiming readjusted at a dealer or by a qualified technician.

Models with headlight adjuster

You can adjust the low beam headlight angle by your self.

✦ **Headlight Adjuster*** P. 179

Models with high voltage discharge tube bulbs

Your vehicle is equipped with the automatic headlight adjusting system that automatically adjusts the vertical angle of the low beam headlights.

* Not available on all models

- Be sure items placed on the floor behind the front seats cannot roll under the seats.
 - ▶ They can interfere with the driver's ability to operate the pedals, or the operation of the seats.
- Everyone in the vehicle must fasten their seat belt.
 - 📄 **Fastening a Seat Belt** P. 42
- Make sure that the indicators in the instrument panel come on when you start the vehicle, and go off soon after.
 - ▶ Always have a dealer check the vehicle if a problem is indicated.
 - 📄 **Indicators** P. 82

Load Limit

When you load luggage, the total weight of the vehicle, all passengers, and luggage must not exceed the maximum permissible weight.

📖 **Specifications** P. 608, 611, 616

The load for the front and rear axles also must not exceed the maximum permissible axle weight.

📖 **Specifications** P. 608, 611, 616

📖 Load Limit

⚠️ WARNING

Overloading or improper loading can affect handling and stability and cause a crash in which you can be hurt or killed.

Follow all load limits and other loading guidelines in this manual.

Towing a Trailer*

"S" grade petrol and 2.0 L engine models*1

Your vehicle is not designed to tow a trailer. Attempting to do so can void your warranties.

Except "S" grade petrol and 2.0 L engine models

Towing Preparation

Towing Load Limits

Your vehicle can tow a trailer if you carefully observe the load limits, use the proper equipment, and follow the towing guidelines. Check the load limits before driving.

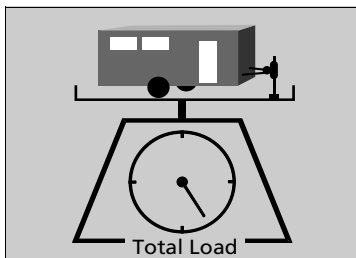

■ Total trailer weight

Do not exceed the maximum towing weight of the trailer and towbar (with/without brakes), luggage and everything in or on it.

Towing loads in excess of the maximum towing weight can seriously affect vehicle handling and performance and can damage the engine and drivetrain.

» Towing Load Limits

⚠ WARNING

Exceeding any load limit or improperly loading your vehicle and trailer can cause a crash in which you can be seriously hurt or killed.

Check the loading of your vehicle and trailer carefully before starting to drive.

Check if all loads are within limits at a public scale. If a public scale is not available, add the estimated weight of your luggage load to the weight of your trailer (as quoted by the manufacturer), and the towbar down load.

Break-in Period

Avoid towing a trailer during your vehicle's first 1,000 km (625 miles).

If you tow a trailer in mountainous conditions, remember to reduce 10% of the combined vehicle and trailer weights from the maximum towing weight for every 1,000 metres of elevation.

Never exceed the maximum towing weight and any specified load limit.

» **Specifications** P. 610, 613, 618

*1: If you are not sure whether your vehicle is capable of towing a trailer, consult an authorised Honda dealer.

* Not available on all models

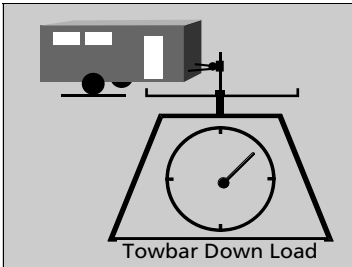

■ Towbar down load

The towbar down load should never exceed 75 kg (165 lbs). This is the amount of weight the trailer puts on the towbar when it is fully-loaded. As a rule of thumb for trailer weights of less than 750 kg (1,653 lbs), the towbar down load should be 10 percent of the total trailer package.

- Excessive towbar down load reduces front tyre traction and steering control. Too little towbar down load can make the trailer unstable and cause it to sway.
- To achieve a proper towbar down load, start by loading 60% of the load towards the front of the trailer and 40% towards the rear. Readjust the load as needed.

■ Towing Equipment and Accessories

Towing equipment varies by the size of your trailer, how much load you are towing, and where you are towing.

■ Towbars

The towbar must be of an approved type and properly bolted to the underbody.

■ Safety chains

Always use safety chains when you tow a trailer. Leave enough slack to allow the trailer to turn corners easily, but do not allow the chains to drag on the ground.

■ Trailer brakes

If you are thinking of getting a trailer that has brakes, be sure they are electronically actuated. Do not attempt to tap into your vehicle's hydraulic system. No matter how successful it may seem, any attempt to attach trailer brakes to your vehicle's hydraulic system will lower braking effectiveness and create a potential hazard.

■ Additional towing equipment

There may be laws requiring special outside mirrors when towing a trailer. Even if mirrors are not required in your locale, you should install special mirrors if visibility is restricted in any way.

■ Trailer light

Trailer lights and equipment must comply with the regulations of the country where you are driving. Check with your local trailer sales or rental agency for the requirements in the area where you plan to tow.

▣ Towing Equipment and Accessories

Make sure that all equipment is properly installed and maintained, and that it meets the country's regulations where you are driving.

Consult your trailer sales or rental agency if any other items are recommended or required for your towing situation.

The lighting and wiring of trailers can vary by type and brand. If a connector is required, it should only be installed by a qualified technician.

Driving Safely with a Trailer

Things You Need To Know Before Towing a Trailer

- Have the trailer properly serviced and keep it in good condition.
- Make sure that all the weights and load in the vehicle and trailer are within limits.
 - ▶ **Towing Load Limits** P. 376
- Securely attach the tow bar, safety chains, and other necessary parts to the trailer.
- Securely store all the items in and on the trailer so that they do not shift while driving.
- Check if the lights and brakes on the trailer are working properly.
- Check the pressures of the trailer tyres, including the spare.
- Check regulations concerning the maximum speed or driving restrictions for vehicles towing trailers. If you are driving across several countries, check each country's requirements before leaving home, because regulations may vary.

Models with Auto Idle Stop

- Turn off the Auto Idle Stop system using the Auto Idle Stop system OFF button. The trailer weight can affect your vehicle's brake effectiveness if Auto Idle Stop is activated on a hill while towing a trailer.

Driving Safely with a Trailer

Operating speed when towing a trailer is restricted up to 100 km/h (62 mph).

Parking

In addition to the normal precautions, place wheel chocks at each of the trailer's tyres.

We recommend you drive uphill of less than 12% slope. Follow the trailer association's recommendations for suitable roads.

Winds caused by passing large vehicles can sway your trailer, keep a constant speed and steer straight ahead.

Always drive slowly and have someone guide you when reversing.

Continued

■ Towing Speeds and Gears

- Drive slower than normal.
- Obey posted speed limits for vehicles with trailers.

Automatic transmission models

- Use the **D** position when towing a trailer on level roads.

Manual transmission models

Either shift up or shift down indicator will come on at the best time to shift to a higher or lower gear for the better fuel economy.

▣ Towing Speeds and Gears

The shift down indicator will not prompt to downshift to 1st gear. It is up to you to downshift to 1st gear to increase engine braking. Avoid sudden engine braking.

Road and traffic conditions may require you to shift at times other than those indicated.

■ Turning and Braking

- Turn more slowly and with a wider turning arc than normal.
- Allow more time and distance for braking.
- Do not brake or turn suddenly.

■ Driving in Hilly Terrain

- Monitor your temperature gauge. If it nears the red (Hot) mark, turn off the climate control system and reduce speed. Pull to the side of the road safely to cool down the engine if necessary.

Automatic transmission models

- Shift to the **S** position if the transmission shifts frequently.

Models without keyless access system

Starting the Engine

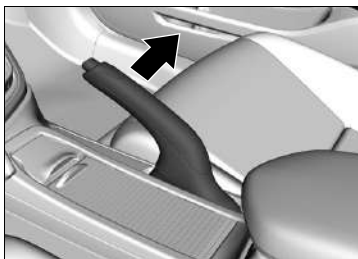

1. Make sure the parking brake is applied.

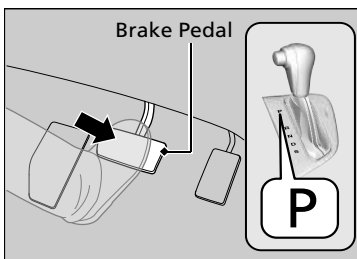

Automatic transmission models

2. Check that the shift lever is in **P**, then depress the brake pedal.
 - ▶ Although it is possible to start the vehicle in **N**, it is safer to start it in **P**.

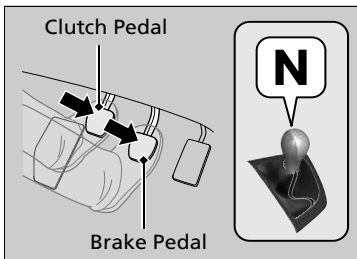

Manual transmission models

2. Check that the shift lever is in **N**. Then depress the brake pedal with your right foot, and the clutch pedal with your left foot.
 - ▶ The clutch pedal must be fully depressed to start the engine.

▶ Starting the Engine

Keep your foot firmly on the brake pedal when starting the engine.

Petrol models

The engine is harder to start in cold weather and in thinner air found at altitudes above 2,400 metres (8,000 feet).

When starting the engine in cold weather, turn off all electrical accessories such as the lights, climate control system, and rear demister in order to reduce battery drain.

If the exhaust system sounds abnormal or you can smell exhaust gas inside the vehicle, have your vehicle checked by a dealer. There may be a problem with the engine or exhaust system.

The immobilizer system protects your vehicle from theft. If an improperly coded key (or other device) is used, the engine's fuel system is disabled.

▶ **Immobilizer System** P. 162

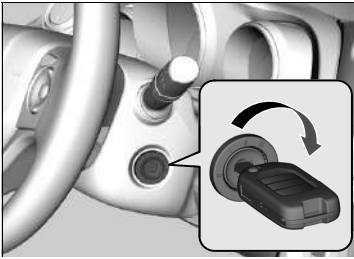

3. Turn the ignition switch to START  without depressing the accelerator pedal.

▶▶Starting the Engine

Do not hold the key in START  for more than 10 seconds.

Petrol models

- If the engine does not start right away, wait for at least 30 seconds before trying again.
- If the engine starts, but then immediately stops, wait at least 30 seconds before repeating step 3 while gently depressing the accelerator pedal. Release the accelerator pedal once the engine starts.

Diesel models

- If the engine does not start right away, wait for at least 30 seconds before trying again.
- If the engine starts, but then immediately stops, wait at least 30 seconds before repeating step 3 while gently depressing the accelerator pedal. Release the accelerator pedal once the engine starts.

Diesel models

When the ambient temperature is extremely low, the engine peak power may be restricted at starting the engine. This is to help the fuel flow for the normal engine operation.

Diesel models

NOTICE

For proper lubrication, the engine must not be run above fast idle speed until the low oil pressure indicator goes off.

Avoid harsh acceleration or labouring the engine before the normal operating temperature has been reached.

Continued

Starting to Drive

Automatic transmission models

1. Keeping your right foot on the brake pedal, release the parking brake. Check that the parking brake indicator has gone off.
 - **Parking Brake** P. 430
2. Put the shift lever in **D**. Select **R** when reversing.
3. Gradually release the brake pedal and gently depress the accelerator pedal to pull away.

Hill start assist system

Hill start assist keeps the brake engaged briefly to help to prevent the vehicle from rolling on inclines as you move your foot from the brake pedal to the accelerator.

Manual transmission models

Depress the clutch pedal, and shift to one of the forward gears when facing uphill, or **R** when facing downhill, then release the brake pedal.

Automatic transmission models

Move the shift lever to **D** or **S** when facing uphill, or **R** when facing downhill, then release the brake pedal.

Starting to Drive

Manual transmission models

If the engine stalls, fully depress the clutch pedal within three seconds. The engine may automatically restart under certain conditions. Otherwise, follow the standard procedure.

Hill start assist system

Hill start assist may not prevent the vehicle from rolling downhill on a very steep or slippery slope, and does not operate on small inclines.

Hill start assist is not a replacement for the parking brake.

Models with keyless access system

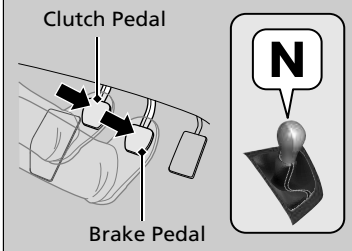
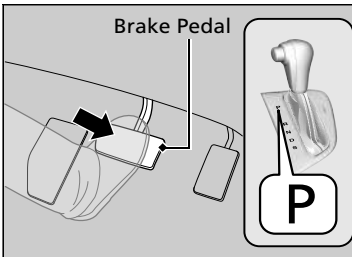
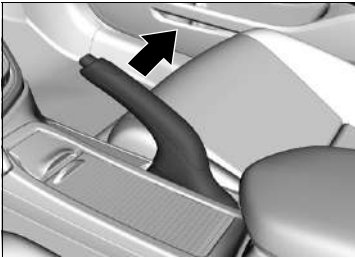
Starting the Engine

1. Make sure the parking brake is applied.

Automatic transmission models

2. Check that the shift lever is in **P**, then depress the brake pedal.
 - ▶ Although it is possible to start the vehicle in **N**, it is safer to start it in **P**.

Manual transmission models

2. Check that the shift lever is in **N**. Then depress the brake pedal with your right foot, and the clutch pedal with your left foot.
 - ▶ The clutch pedal must be fully depressed to start the engine.

Starting the Engine

Keep your foot firmly on the brake pedal when starting the engine.

Petrol models

The engine is harder to start in cold weather and in thinner air found at altitudes above 2,400 metres (8,000 feet).

When starting the engine in cold weather, turn off all electrical accessories such as the lights, climate control system, and rear demister in order to reduce battery drain.

If exhaust system sounds abnormal or you can smell exhaust gas inside the vehicle, have your vehicle checked by a dealer. There may be a problem with the engine or exhaust system.

The immobilizer system protects your vehicle from theft. If an improperly coded key (or other device) is used, the engine's fuel system is disabled.

▶ **Immobilizer System** P. 162

Continued

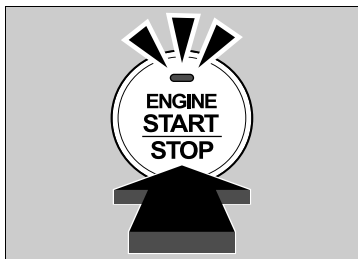

All models

3. Press the **ENGINE START/STOP** button without depressing the accelerator pedal.

Stopping the Engine

You can turn the engine off when the vehicle is completely stopped.

Diesel models

Idle the engine for 10 seconds before turning off the engine.

Automatic transmission models

1. Shift to **P**.
2. Press the **ENGINE START/STOP** button.

Manual transmission models

- If the shift lever is in **N**, press the **ENGINE START/STOP** button.
- If the shift lever is in any gear other than **N**, depress the clutch pedal, then press the **ENGINE START/STOP** button.

Starting the Engine

Bring the keyless remote close to the **ENGINE START/STOP** button if the battery in the keyless remote is weak.

➤ **If the Keyless Remote Battery is Weak** P. 576

The engine may not start if the keyless remote is subjected to strong radio waves.

Do not hold the **ENGINE START/STOP** button to start the engine.

Petrol models

If the engine does not start, wait at least 30 seconds before trying again.

Diesel models

If the engine does not start, wait at least 30 seconds before trying again.

Diesel models

When the ambient temperature is extremely low, the engine peak power may be restricted at starting the engine. This is to help the fuel flow for the normal engine operation.

Diesel models

NOTICE

For proper lubrication, the engine must not be run above fast idle speed until the oil pressure warning indicator goes off.

Avoid harsh acceleration or labouring the engine before the normal operating temperature has been reached.

Starting to Drive

Automatic transmission models

1. Keeping your right foot on the brake pedal, release the parking brake. Check that the parking brake indicator has gone off.
 ➤ **Parking Brake** P. 430
2. Put the shift lever in **[D]**. Select **[R]** when reversing.
3. Gradually release the brake pedal and gently depress the accelerator pedal to pull away.

Hill start assist system

Hill start assist keeps the brake engaged briefly to help to prevent the vehicle from rolling on inclines as you move your foot from the brake pedal to the accelerator.

Manual transmission models

Depress the clutch pedal, and shift to one of the forward gears when facing uphill, or **[R]** when facing downhill, then release the brake pedal.

Automatic transmission models

Move the shift lever to **[D]** or **[S]** when facing uphill, or **[R]** when facing downhill, then release the brake pedal.

Starting to Drive

Manual transmission models

If the engine stalls, fully depress the clutch pedal within three seconds. The engine may automatically restart under certain conditions. Otherwise, follow the standard procedure.

Hill start assist system

Hill start assist may not prevent the vehicle from rolling downhill on a very steep or slippery slope, and does not operate on small inclines.

Hill start assist is not a replacement for the parking brake.

Precautions While Driving

In Rain

Avoid driving in deep water and on flooded roads. This can damage the engine or driveline, or cause electrical component failure.

Precautions While Driving

CAUTION: Do not drive on the road where water is deep. Driving through deep water will cause damage to the engine and electrical equipment and the vehicle will break down.

NOTICE

Do not operate the shift lever while pressing the accelerator pedal. You could damage the transmission.

NOTICE

If you repeatedly turn the steering wheel at an extremely low speed, or hold the steering wheel on the full left or right position for a while, the electric power steering (EPS) system heats up. The system goes into a protective mode, and limits its performance. The steering wheel becomes harder and harder to operate. Once the system cools down, the EPS system is restored. Repeated operation under these conditions can eventually damage the system.

Other Precautions

If there is a strong impact with something under the vehicle, stop in a safe location. Check the underside of the vehicle for damage or any fluid leaks.

Automatic Transmission *

Creeping

The engine runs at a higher idle speed and creeping increases. Keep the brake pedal firmly depressed when stopped.

Kickdown

Quickly depressing the accelerator pedal while driving uphill may cause the transmission to drop to a lower gear, unexpectedly increasing vehicle speed. Depress the accelerator pedal carefully, especially on slippery roads and curves.

Precautions While Driving

If the ignition switch is turned to ACCESSORY **I** or LOCK **0***¹ while driving, the engine will shut down and all steering and brake power assist functions will stop, making it difficult to control the vehicle.

Do not put the shift lever in **N**, as you will lose engine braking (and acceleration) performance.

During the first 1,000 km (625 miles) of operation, avoid sudden acceleration or full throttle operation so as not to damage the engine or powertrain.

Avoid hard braking for the first 300 km (200 miles). You should also follow this when the brake pads are replaced.

* 1: Models with the keyless access system have an **ENGINE START/STOP** button instead of an ignition switch.

* Not available on all models

Automatic transmission models

Shifting

Change the shift position in accordance with your driving needs.

■ Shift lever positions

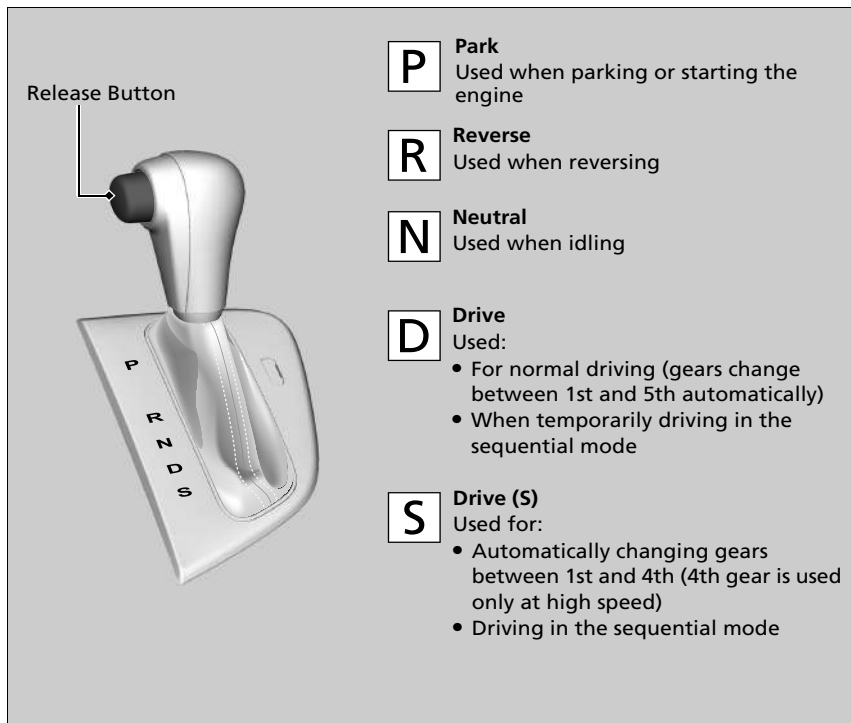

▶▶ Shifting

You cannot turn the ignition switch to LOCK **0***1 and remove the key unless the shift lever is in **P**.

The vehicle may move forward very slightly even in **N** while the engine is cold. Depress the brake pedal firmly and, when necessary, apply the parking brake.

*1: Models with the keyless access system have an **ENGINE START/STOP** button instead of an ignition switch.

Shift Lever Operation

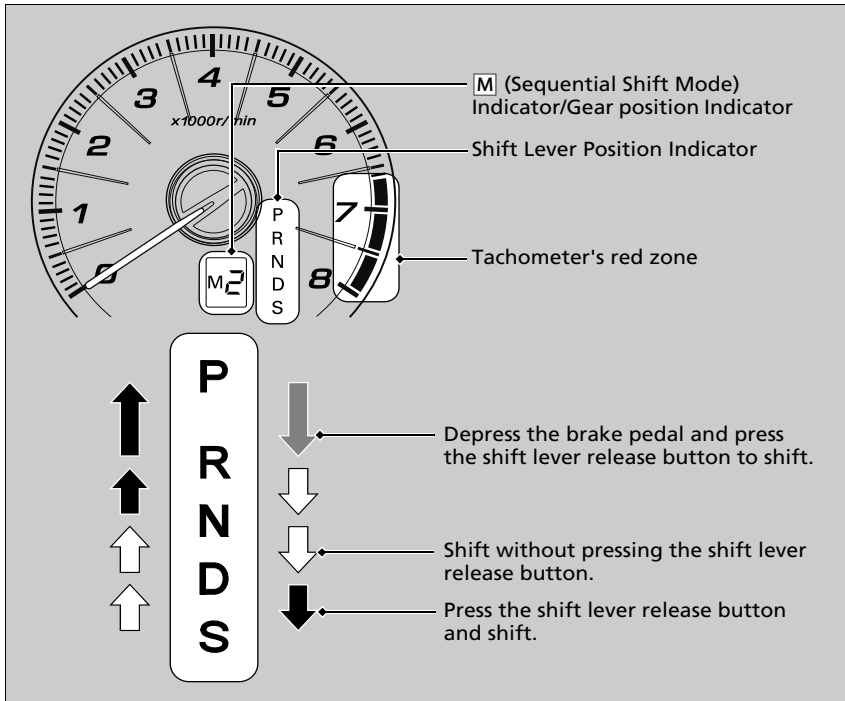

Shift Lever Operation

NOTICE

When you change the shift lever from **D** to **R** and vice versa, come to a complete stop and keep the brake pedal depressed. Operating the shift lever before the vehicle has come to a complete standstill can damage the transmission.

Use the shift lever position indicator to check the lever position before pulling away.

Whichever position the shift lever is in when driving, a blinking **D** indicator indicates a transmission problem. Avoid sudden acceleration and have the transmission checked by a dealer as soon as possible.

The fuel supply may be cut off if you drive at engine speeds in or over the tachometer's red zone (engine speed limit). If this happens, you may experience a slight jolt.

It may not be possible to operate the shift lever if the brake pedal is applied while the shift lever release button is held down. Depress the brake pedal first.

■ Sequential Shift Mode

Use the paddle shifters to change between 1st and 5th gears without removing your hands from the steering wheel. The transmission switches to the sequential shift mode.

■ When the shift lever is in **[D]**:

The vehicle goes into the sequential shift mode momentarily, and the gear position indicator comes on.

Once you start travelling at a constant speed, the sequential shift mode automatically switches off, and the gear position indicator goes off.

Hold the **[+]** paddle shifter for two seconds to return to normal drive.

■ When the shift lever is in **[S]**:

The vehicle goes into the sequential shift mode, and the **[M]** (sequential shift mode) indicator and gear position indicator comes on. At speeds of 10 km/h (6 mph) or less, the vehicle automatically shifts down into 1st gear. It does not automatically shift up, even if vehicle speed increases.

You can only pull away in 1st or 2nd gear.

When switching out of the sequential shift mode, move the shift lever from **[S]** to **[D]**. When the sequential shift mode is cancelled, the **[M]** indicator and gear position indicator go off.

■ Second gear lock mode

If you pull the **+** paddle shifter while stopped or driving at 10 km/h (6 mph) or less, the gear position will be locked in 2nd gear. This makes it easier to pull away on slippery surfaces such as snow covered roads.

To cancel the 2nd gear lock mode, pull the **-** paddle shifter, or move the shift lever from **[S]** to **[D]**.

■ Sequential Shift Mode Operation

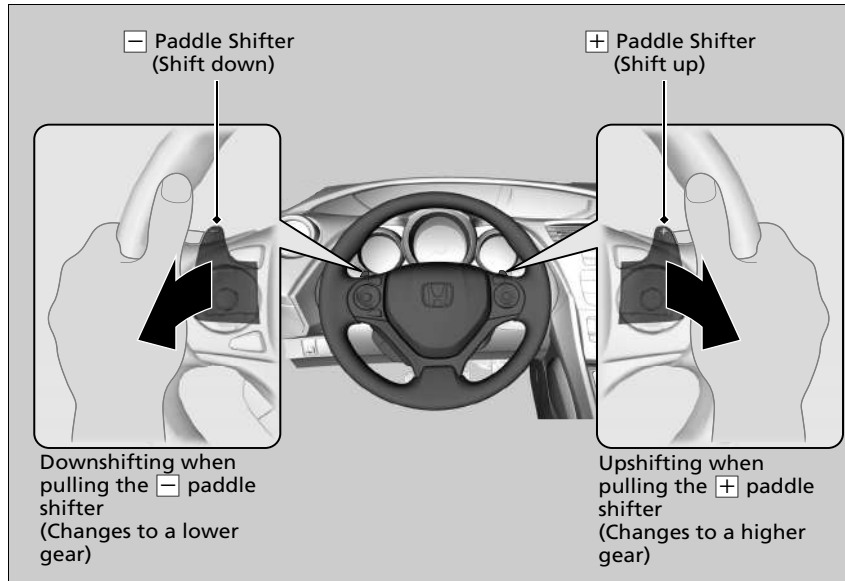

Continued

▣ Sequential Shift Mode Operation

Each paddle shift operation makes a single gear change.

To change gears continuously, release the paddle shifter before pulling it again for the next gear.

If your vehicle speed is not in its allowable gear shifting range, the gear position indicator blinks while trying to shift up or down. Slightly accelerate to shift up and decelerate to shift down while the indicator is blinking.

■ Shift Up/Down Indicators

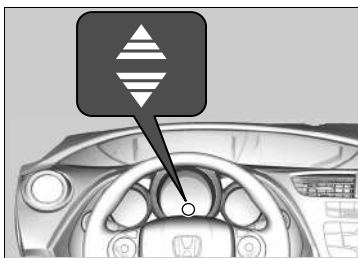

Come on while the vehicle is in the sequential shift mode to indicate when a gear change is appropriate to maintain the most fuel efficient driving style.

The shift up indicator: Comes on when shifting up is recommended.

The shift down indicator: Comes on when shifting down is recommended.

▣ Shift Up/Down Indicators

⚠ WARNING

The shift indicator is only a guide to help you achieve better fuel economy. **Never refer to the Shift Indicators when road and traffic conditions are unsuitable or when it may distract you.**

This indicator will not prompt you to downshift to increase engine braking. It is up to you to downshift to increase engine braking when driving downhill.

Always shift down at the appropriate vehicle speed.

Models with ECON system

When the ECON mode is on, ambient meter colour may change if you do not change gears when a shift indicator illuminates. This can result in a change in fuel economy.

Road and traffic conditions may require you to shift at times other than those indicated.

Manual transmission models

Shifting

Shift Lever Operation

Fully depress the clutch pedal to operate the shift lever and change gears, then slowly release the pedal.

Depress the clutch pedal, and pause for a few seconds before shifting into **[R]**, or shift into one of the forward gears for a moment. This stops the gears so they do not “grind.”

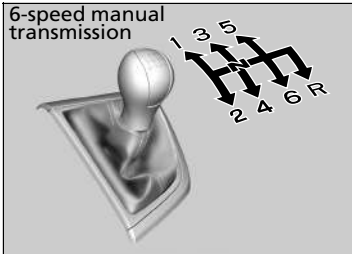

When you are not shifting, do not rest your foot on the clutch pedal. This can cause your clutch to wear out faster.

Shifting

NOTICE

Do not shift to **[R]** before the vehicle comes to a complete stop. Shifting to **[R]** before stopping can damage the transmission.

NOTICE

Before downshifting, make sure the engine will not go into the tachometer's red zone. Should this occur, it can severely damage your engine.

There is a metallic part on the shift lever. If you leave the vehicle parked outside for a long time on a hot day, be careful before moving the shift lever. Because of heat, the shift lever may be extremely hot. If the outside temperature is low, the shift lever may feel cold.

If you exceed the maximum speed for the gear you are in, the engine speed will enter into the tachometer's red zone. When this happens, you may experience a slight jolt.

Continued

Shift Up/Down Indicators

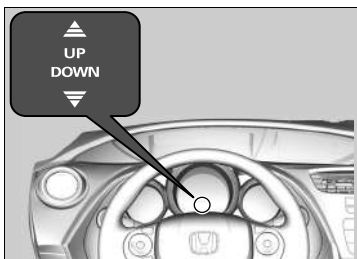

Come on to indicate when a gear change is appropriate to maintain the most fuel efficient driving style.

The shift up indicator: Comes on when shifting up is recommended.

The shift down indicator: Comes on when shifting down is recommended.

Shift Up/Down Indicators

⚠ WARNING

The shift indicator is only a guide to help you achieve better fuel economy. **Never refer to the Shift Indicators when road and traffic conditions are unsuitable or when it may distract you.**

The shift down indicator will not prompt you to downshift to increase engine braking. It is up to you to downshift to increase engine braking when driving downhill.

Always shift down at the appropriate vehicle speed.

The shift down indicator does not come on when downshifting from **2** to **1**.

Models with ECON system

When the ECON mode is on, ambient meter colour may change if you do not change gears when a shift indicator illuminates. This can result in a change in fuel economy.

Road and traffic conditions may require you to shift at times other than those indicated.

Reverse Lockout

The manual transmission has a lockout mechanism that stops you from accidentally shifting into **R** from a forward gear while the vehicle is moving above a certain speed.

If you cannot shift to **R** when the vehicle is stopped, do the following:

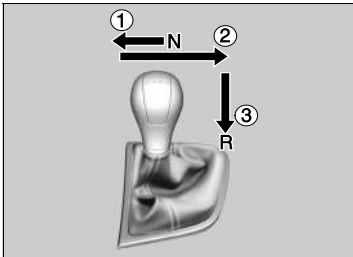

1. Depress the clutch pedal, move the shift lever all the way to the left, and shift to **R**.
2. If you still cannot shift into **R**, apply the parking brake, and turn the ignition switch to ACCESSORY **I** or LOCK **O***1.
3. Depress the clutch pedal and shift into **R**.
4. Keep depressing the clutch pedal and start the engine.

Have your vehicle checked by a dealer if you have to go through this procedure repeatedly.

*1: Models with the keyless access system have an **ENGINE START/STOP** button instead of an ignition switch.

Manual transmission models

Auto Idle Stop

To help to maximise fuel economy, the engine automatically stops when the vehicle comes to a stop, depending on environmental and vehicle operating conditions. The indicator (green) comes on.

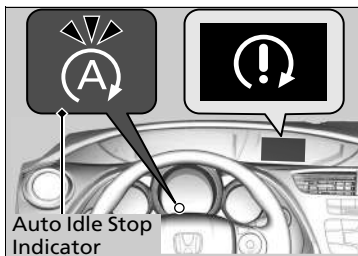

The engine then restarts once the vehicle is about to move again when you depress the clutch pedal, and the indicator goes off. A message associated with Auto Idle Stop appears on the i-multi-information display.

➤ **Indicators** P. 82

➤ **Customized Features** P. 131

If the driver's door is opened while the indicator (green) is on, a buzzer sounds to notify you that the Auto Idle Stop function is in operation.

Auto Idle Stop System On and Off

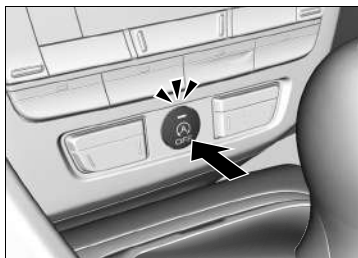

To turn the Auto Idle Stop system off, press this button. The Auto Idle Stop system stops.

▶ Auto Idle Stop system will stop and the indicator will come on.

When the +R mode is on, the Auto Idle Stop system cannot be operated.

The Auto Idle Stop system is turned on every time you start the engine, even if you turned it off the last time you drove the vehicle.

Auto Idle Stop

The battery installed in this vehicle is specifically designed for a model with Auto Idle Stop. Using a battery other than this specified type may shorten the battery life, and prevent Auto Idle Stop from activating. If you need to replace the battery, make sure to select the specified type. Ask a dealer for more details.

➤ **Specifications** P. 608

The duration of the Auto Idle Stop operation increases in the ECON mode*, compared to when the ECON mode is off, with climate control in use.

Auto Idle Stop System On and Off

Pressing the Auto Idle Stop system **OFF** button restarts the engine during the Auto Idle Stop activated.

■ Auto Idle Stop Activates When:

The Auto Idle Stop is activated after the vehicle has come to a stop and the shift lever is in **[N]** with the clutch released.

▶ To restart the engine automatically, depress the clutch pedal.

■ Auto Idle Stop does not activate when:

- The engine coolant temperature is low or high.
- The vehicle comes to a stop again before the vehicle speed reaches 3 km/h (2 mph) after the engine starts.
- The shift lever is in any position except **[N]**.
- The climate control system is in use with the driver side temperature set to the lower or upper limit, displaying **Lo** or **Hi**.
- The climate control system is in use, and the ambient temperature is -20°C or lower, or 40°C or higher.
-  is on (indicator on).
- You are not wearing a seat belt.
- The engine is started with the bonnet open.
 - ▶ Turn off the engine. Close the bonnet before you restart the engine to activate auto idle stop.
- The battery charge is low.

2.0 L engine models

- The +R mode is on.

▶ Auto Idle Stop Activates When:

Do not open a bonnet, during idling stop. If the bonnet is opened, the engine will not restart automatically.

In this case, restart the engine with the **ENGINE START/STOP** button * or turn the ignition switch to **START [III]**.

▶ **Starting the Engine** P. 382, 385

Models with keyless access system

Pressing the **ENGINE START/STOP** button changes the power mode to VEHICLE OFF (LOCK) even while Auto Idle Stop is in operation. Once in VEHICLE OFF (LOCK), the engine no longer restarts automatically. Follow the standard procedure to start the engine.

▶ **Starting the Engine** P. 382, 385

* Not available on all models

■ **Auto Idle Stop may not activate when:**

- The climate control system is in use, and the fan speed is selected to high.
- The climate control system is in use, and the ambient conditions may be different from the climate control settings you have selected.
- When humidity in the interior is high.
- The steering wheel is operated.

Petrol models

- Altitude is high.

■ **The Engine Automatically Restarts When:**

The clutch pedal is depressed.

■ **The engine automatically restarts even if the clutch pedal is not depressed with the shift lever in **[N]** When:**

- The Auto Idle Stop system OFF button is pressed.
- Your vehicle is moved.
- The pressure on the brake pedal is repeatedly applied and released slightly during a stop.
- The battery charge becomes low.
- The steering wheel is operated.

2.0 L engine models

- The +R mode is on.

▶▶ The Engine Automatically Restarts When:

If you are using an electronic device during Auto Idle Stop, the device may temporarily be turned off when the engine restarts.

The engine does not restart automatically when there is a problem in the system. Follow the normal procedure to start the engine.

▶▶ **Starting the Engine** P. 382, 385

The engine does not restart automatically when:

- The driver's seat belt is unlatched.
Fasten the driver's seat belt to keep the Auto Idle Stop activated.
- The shift lever is moved from **[N]** to any other position. Shift to **[N]**.

▶▶ **i-Multi-Information Display Warning and Information Messages** P. 103

When the system stops operating, follow the normal procedure to start the engine.

▶▶ **Starting the Engine** P. 382, 385

■ When the Auto Idle Stop Indicator (Green) Starts Blinking Rapidly

Fully depress the clutch pedal.

- ▶ The engine automatically restarts.

▣ When the Auto Idle Stop Indicator (Green) Starts Blinking Rapidly

The indicator starts blinking rapidly under the following conditions:

-  (Windscreen demister) is touched.
- When the climate control system is in use and moisture builds up inside the vehicle.
- When the climate control system is in use and the difference between the set temperature and the actual temperature inside the vehicle becomes significant.

ECON Button *



The **ECON** button turns the ECON mode on and off.

Petrol models

The ECON mode helps you to improve your fuel economy by adjusting the performance of the engine, transmission, climate control system and cruise control.

Diesel models

The ECON mode helps you to improve your fuel economy by adjusting the performance of the transmission, climate control system and cruise control.

+R Button *

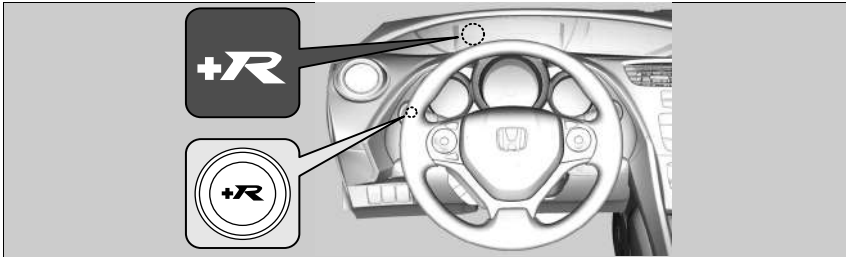

The **+R** button turns the +R mode on and off.

When you press the **+R** button, engine, suspension, EPS, and VSA are adjusted, enabling sporty driving.

📖 **i-Multi-Information Display** P. 120

Cruise Control *

Maintains a constant vehicle speed without having to keep your foot on the accelerator pedal. Use cruise control on motorways or open roads where you can travel at a constant speed with little acceleration or deceleration.

▶▶ Cruise Control *

⚠ WARNING

Improper use of the cruise control can lead to a crash.

Use the cruise control only when travelling on open motorways in good weather.

It may not be possible to maintain a constant speed when driving uphill or downhill.

Manual transmission models

When the engine speed slows down, try to downshift. You can maintain the set speed if you change gear within five seconds.

When not using cruise control: Turn off cruise control by pressing the **MAIN** button.

Models with ECON system

It may take more time to accelerate in ECON mode.

You cannot use cruise control and the adjustable speed limiter at the same time.

When to use

- Vehicle speed for cruise control: Desired speed in a range from about 30 km/h (18 mph) to about 200 km/h (125 mph)

Always keep sufficient distance between you and the vehicle in front of you.

Automatic transmission models

- Shift positions for cruise control: In **D** or **S**

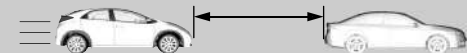

How to use

- Press the **MAIN** button on the steering wheel



If a different indicator comes on, press the **LIM** button to switch the cruise control.



The indicator is on in the instrument panel

Cruise control is ready to use.

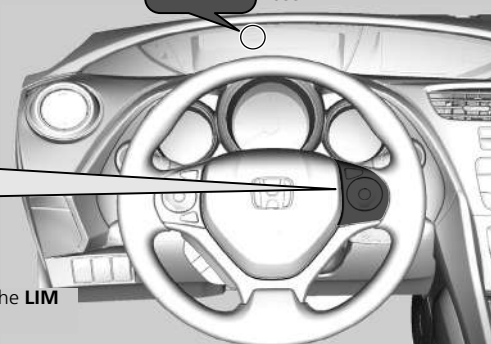

■ To Set the Vehicle Speed

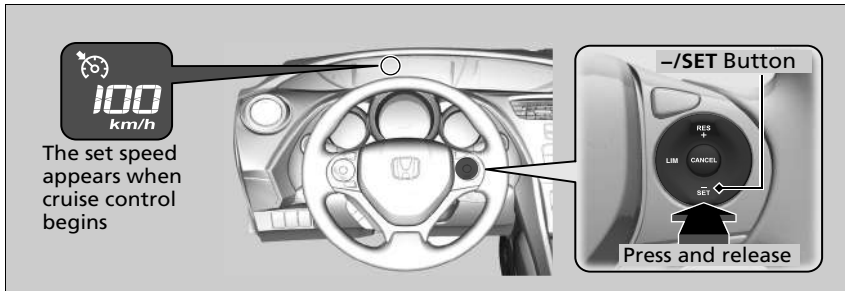

Take your foot off the accelerator pedal and press the **-/SET** button when you reach the desired speed.

The moment you release the **-/SET** button, the set speed is fixed, and cruise control begins. The set speed is displayed.

■ To Adjust the Vehicle Speed

Increase or decrease the vehicle speed using the **RES/+** or **-/SET** buttons on the steering wheel.

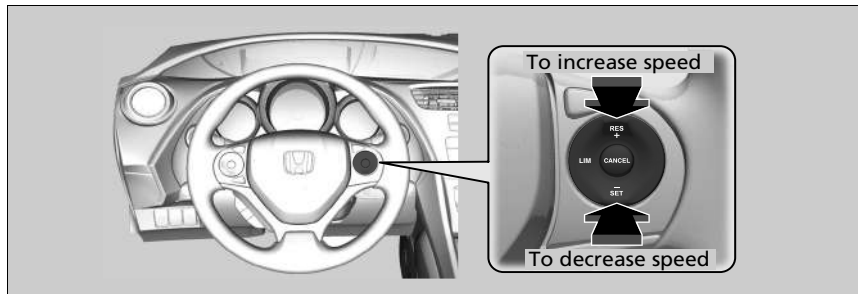

- Each time you press the button, the vehicle speed is increased or decreased by about 1 km/h or 1 mph accordingly.
- If you keep the button pressed, the vehicle speed increases or decreases by about 10 km/h or 10 mph accordingly.

■ To Cancel

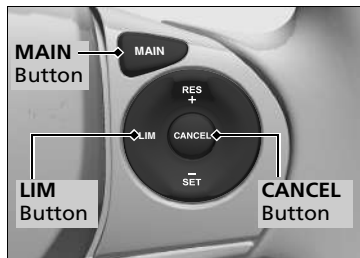

To cancel cruise control, do any of the following:

- Press the **CANCEL** button.
- Press the **MAIN** button.
- Press the **LIM** button.
- Depress the brake pedal.
- Depress the clutch pedal for five seconds or more.

The displayed set speed goes off.

▶▶ To Cancel

Resuming the prior set speed:

After cruise control has been cancelled, you can still resume the prior set speed by pressing the **RES/+** button while driving at a speed of at least 30 km/h (18 mph) or more.

You cannot set or resume in the following situations:

- When vehicle speed is less than 30 km/h (18 mph)
- When the **MAIN** button is turned off

At vehicle speeds of 25 km/h (16 mph) or less, cruise control is cancelled automatically.

Adjustable Speed Limiter*

This system enables you to set a maximum speed that cannot be exceeded even if you are depressing the accelerator pedal.

1.4 L engine, 1.8 L engine, and diesel engine models

The vehicle speed limit can be set from about 30 km/h (18 mph) to about 250 km/h (156 mph).

2.0 L engine models

The vehicle speed limit can be set from about 30 km/h (18 mph) to about 320 km/h (200 mph).

How to use

- Press the **MAIN** button on the steering wheel

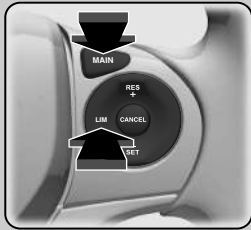

LIM

The indicator is on in the instrument panel

Adjustable speed limiter is ready to use.

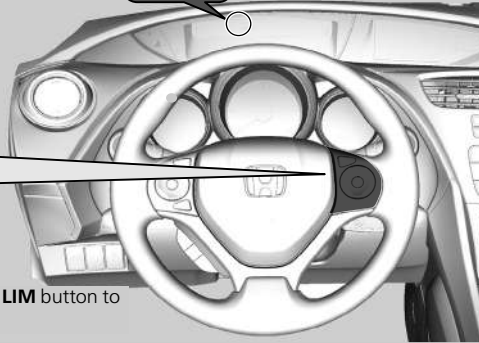

If a different indicator comes on, press the **LIM** button to switch to the adjustable speed limiter.

Adjustable Speed Limiter*

The adjustable speed limiter may not hold the set speed limit when driving downhill. If this occurs, slow down by depressing the brake pedal.

When not using the adjustable speed limiter: Turn off the adjustable speed limiter by pressing the **MAIN** button.

You cannot use the adjustable speed limiter and cruise control at the same time.

Manual transmission models

When the engine speed slows down, try to downshift.

* Not available on all models

Continued

■ To Set the Vehicle Speed

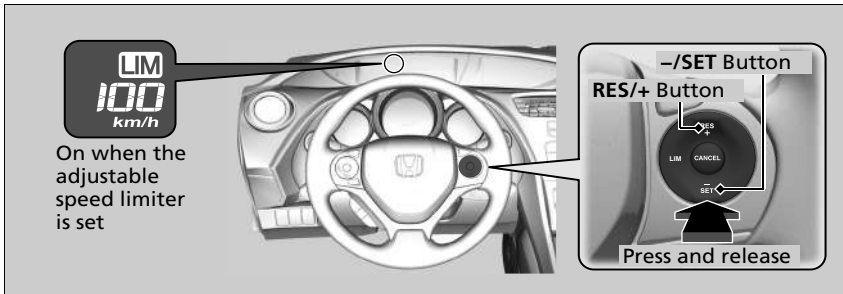

- Take your foot off the pedal and press the **-/SET** button when you reach the desired speed.
The moment you release the **-/SET** button, the set speed is fixed, and the adjustable speed limiter is set. The set speed is displayed.
- You can set the previously set speed limit by pressing the **RES/+** button.

▣ To Set the Vehicle Speed

If you set the speed limit while travelling at less than 30 km/h (18 mph), the speed limit is set to 30 km/h (18 mph).

The beeper sounds and the displayed speed limit blinks if the vehicle speed exceeds the limit by 3 km/h (2 mph) or more on a steep descent.

The adjustable speed limiter is set to the current speed if it is higher than the previously set speed limit when you press the **RES/+** button.

■ To Adjust the Speed Limit

Increase or decrease the speed limit by using the **RES/+** or **-/SET** buttons on the steering wheel.

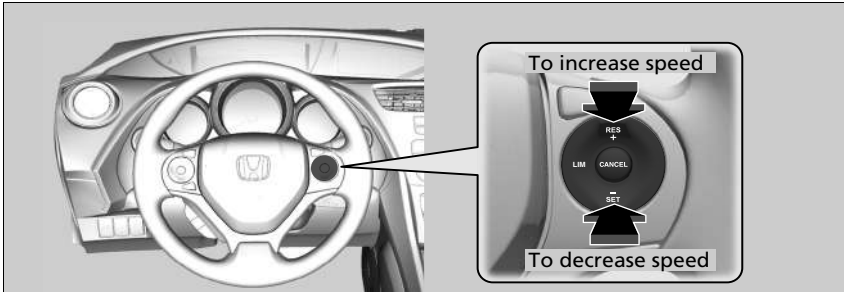

- Each time you press the button, the speed limit is increased or decreased by about 1 km/h or 1 mph accordingly.
- If you keep the button pressed, the speed limit is increased or decreased by about 10 km/h or 10 mph accordingly.

■ Exceeding the Speed Limit Temporarily

The speed limit can be exceeded by depressing the accelerator pedal fully.

- ▶ The displayed limit speed blinks.

⊠ Exceeding the Speed Limit Temporarily

The beeper sounds when the accelerator pedal is depressed fully.

The adjustable speed limiter resumes working once the vehicle speed goes lower than the set speed limit.

Continued

■ To Cancel

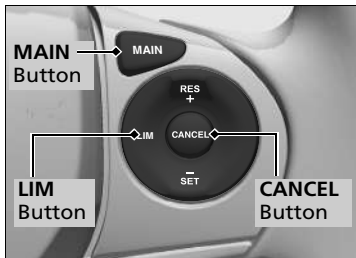

To cancel the adjustable speed limiter, do any of the following:

- Press the **CANCEL** button.
- Press the **MAIN** button.
- Press the **LIM** button.

☒ To Cancel

The adjustable speed limiter changes into cruise control if the **LIM** button is pressed.

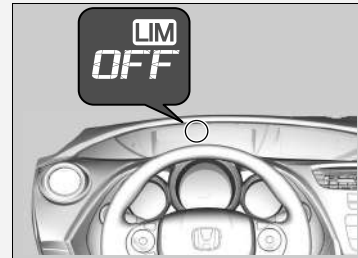

If there is a problem with the system when you are using the adjustable speed limiter, the beeper sounds and **OFF** comes on. The adjustable speed limiter will be turned off.

Forward Collision Warning*

Alerts you when it detects the possibility of your vehicle colliding with the vehicle in front of yours.

If the system determines a collision is possible, it gives both visual and audible alerts.

- ▶ Take appropriate action to prevent a collision (apply the brakes, change lanes, etc.).

■ How the system works

The system may give warnings of potential collisions when your vehicle speed is above 15 km/h (9 mph).

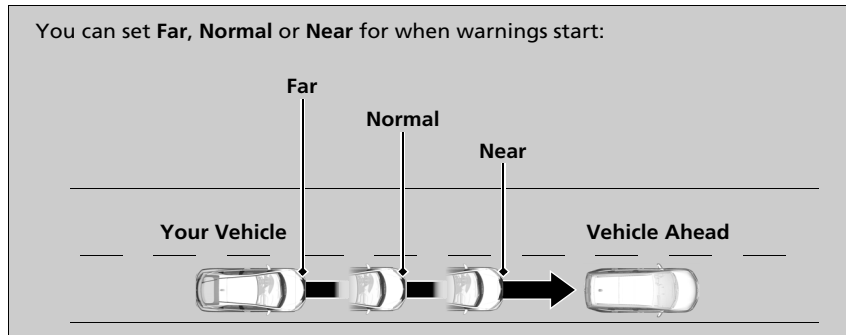

* Not available on all models

Continued

▣ Forward Collision Warning*

Important Safety Reminder

Forward Collision Warning cannot detect all objects ahead and may not detect a given object; accuracy of the system will vary based on weather, speed and other factors. Forward Collision Warning does not include a braking function. It is always your responsibility to safely operate the vehicle and avoid collisions.

You can change the Forward Collision Warning Distance setting or turn the system on and off.

▣ **Customized Features** P. 131

The camera is shared with Lane Departure Warning, Traffic Sign Recognition System and High beam Support System.

For the system's proper operation:

- Do not impact the camera or the area around the camera when you clean the windscreen.
- Keep the upper windscreen clean. Wipe away any debris including ice and frost.

Consult a dealer in the following cases.

- The camera or the area around the camera is severely impacted.
- The area around the windscreen needs repair.

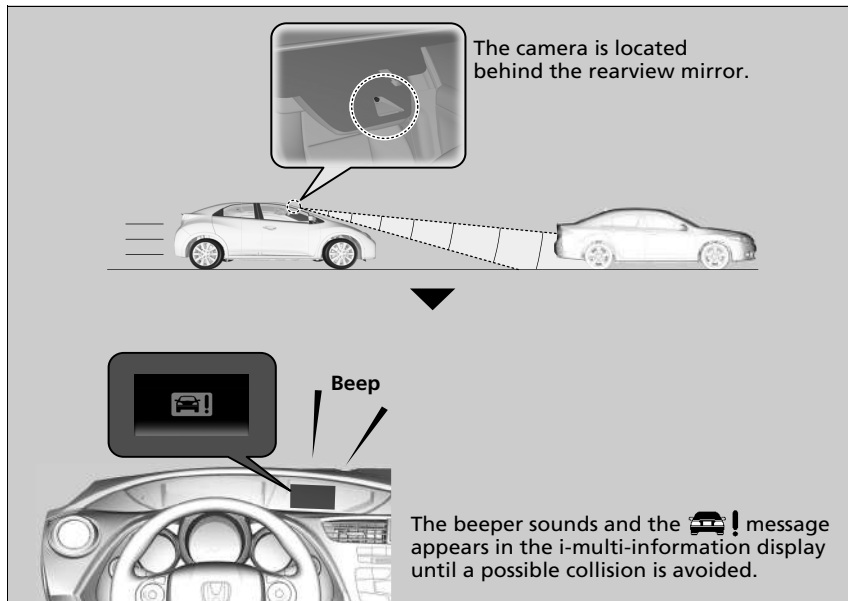

Forward Collision Warning*

Never apply a film or attach any objects to the windshield that could obstruct the Forward Collision Warning camera's field of vision.

Scratches, nicks, and other damage to the windshield within the Forward Collision Warning camera's field of vision can cause the system to operate abnormally. If this occurs, we recommend that you replace the windshield with a genuine Honda replacement windshield. Making even minor repairs within the camera's field of vision or installing an aftermarket replacement windshield may also cause the system to operate abnormally.

After replacing the windshield, have a dealer recalibrate the camera. Proper calibration of the Forward Collision Warning camera is necessary for the system to operate properly.

■ Automatic shutoff

Forward Collision Warning may automatically shut itself off and the  indicator comes and stays on when:

- The temperature inside the system is high.
- The windshield is blocked by dirt, mud, leaves, wet snow, etc.

Once the conditions that caused Forward Collision Warning to shut off improve or are addressed (e.g., cleaning), the system comes back on.

☒ Automatic shutoff

To help reduce the likelihood that high interior temperatures will cause the camera system to shut off, when parking, find a shady area or face the front of the vehicle away from the sun.

If you use a reflective sun shade, do not allow it to cover the camera housing. Covering the camera can concentrate heat on the camera.

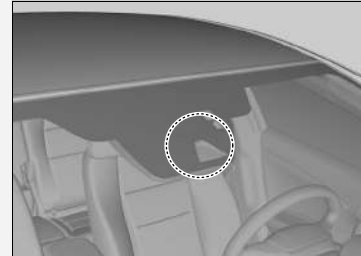

If the **Can Not Operate:**  message appears:

- Use the climate control system to cool down the interior and, if necessary, the demister mode when windows are fogged.
- Start driving the vehicle to lower the windshield temperature, which cools down the area around the Forward Collision Warning camera.

If the **Can Not Operate:**  message appears: Park your vehicle in a safe place. Wipe away debris blocking the windshield, then start driving again. If the message remains on even after driving for a while with the clean windshield, have your vehicle checked by a dealer.

Continued

■ Forward Collision Warning Limitations

Forward Collision Warning may not activate or may not detect a vehicle in front of your vehicle, and may activate even when you are aware of a vehicle ahead of you, or when there is no vehicle ahead, under the following conditions.

Condition

- The distance between your vehicle and the vehicle ahead of you is too short.
- A vehicle cuts in front of you at a slow speed, and it brakes suddenly.
- A vehicle suddenly crosses in front of you.
- When either your vehicle or the vehicle ahead of you accelerates rapidly.
- The vehicle ahead of you is a motorcycle, a small vehicle, or a unique vehicle such as a tractor.
- When you drive off-road or on a mountain road, or curved and winding road for an extended period that makes it difficult for the camera to properly detect a vehicle in front of you.
- When there are pedestrians or animals in front of your vehicle.
- When you drive in bad weather (rain, fog, etc.).
- A heavy load in the rear or modifications to the suspension tilts your vehicle.
- An abnormal tyre condition is detected (wrong tyre size, flat tyre, etc.).
- When the windscreen is blocked by dirt, mud, leaves, wet snow, etc.
- When the temperature inside the system is high.
- A sudden change between light and dark such as an entrance or exit of a tunnel.
- You drive into the sunlight (e.g. at dawn or dusk).
- When the windscreen is dirty or cloudy.
- When streetlights are perceived as the taillight of a vehicle in front of yours.
- When driving at night, the vehicle ahead of you is running with either taillight bulb burned out.
- When you drive in the shadows of trees, buildings, etc.
- When your vehicle is towing a trailer*.

Lane Departure Warning*

Alerts you when the system detects a possibility of your vehicle unintentionally crossing over left or right side lane markings.

How the System Works

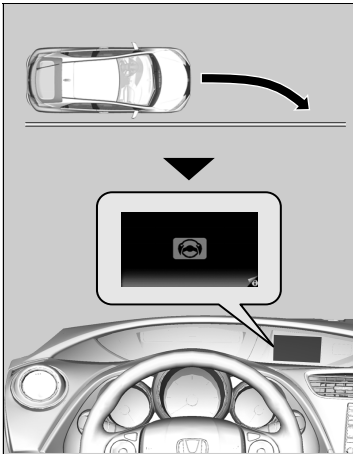

If your vehicle is getting too close to detected left or right side lane markings without a turn signal activated, Lane Departure Warning will give audible and visual alerts.

The beeper sounds and the  message appears on the i-multi-information display, letting you know that you need to take appropriate action.

How the System Activates

The system begins to search for lane markings when all the following conditions are met:

- The vehicle is travelling above 64 km/h (40 mph).
- The vehicle is on a straight or slightly curved road.
- The turn signals are off.
- The brake pedal is not depressed.

* Not available on all models

Continued

☒ Lane Departure Warning*

Important Safety Reminder

Like all assistance systems, Lane Departure Warning has limitations.

Over-reliance on Lane Departure Warning may result in a collision. It is always your responsibility to keep the vehicle within your driving lane.

Lane Departure Warning only alerts you when lane drift is detected without a turn signal in use. Lane Departure Warning may not detect all lane markings or lane departures; accuracy will vary based on weather, speed and lane marker condition. It is always your responsibility to safely operate the vehicle and avoid collisions.

☒ How the System Activates

Lane Departure Warning may automatically shut off and the  indicator comes and stays on.

☒ **Indicators** P. 97

■ Lane Departure Warning Camera

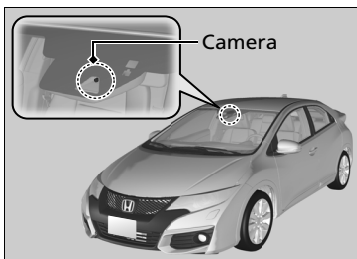

The camera is located behind the rearview mirror.

■ Lane Departure Warning On and Off

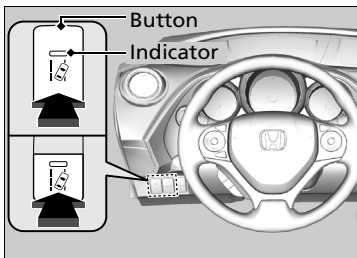

Press the Lane Departure Warning button to turn the system on and off.

- ▶ The indicator in the button comes on when the system is on.

▣ Lane Departure Warning Camera

Never apply a film or attach any objects to the windshield that could obstruct the Lane Departure Warning camera's field of vision.

Scratches, nicks, and other damage to the windshield within the Lane Departure Warning camera's field of vision can cause the system to operate abnormally. If this occurs, we recommend that you replace the windshield with a genuine Honda replacement windshield. Making even minor repairs within the camera's field of vision or installing an aftermarket replacement windshield may also cause the system to operate abnormally.

After replacing the windshield, have a dealer recalibrate the camera. Proper calibration of the Lane Departure Warning camera is necessary for the system to operate properly.

Do not place an object on the top of the instrument panel. It may reflect onto the windshield and prevent the system from detecting lane lines properly.

To help reduce the likelihood that high interior temperatures will cause the camera system to shut off, when parking, find a shady area or face the front of the vehicle away from the sun.

If you use a reflective sun shade, do not allow it to cover the camera housing. Covering the camera can concentrate heat on the camera.

■ Lane Departure Warning Limitations

Lane Departure Warning may not activate or may not recognize lanes, and may activate even when keeping in the middle of a lane, under the following conditions.

Condition

- When you drive in bad weather (rain, fog, etc.).
- A heavy load in the rear or modifications to the suspension tilts your vehicle.
- An abnormal tyre condition is detected (wrong tyre size, flat tyre, etc.).
- When the windscreen is blocked by dirt, mud, leaves, wet snow, etc.
- When the temperature inside the system is high.
- A sudden change between light and dark such as an entrance or exit of a tunnel.
- You drive into the sunlight (e.g. at dawn or dusk).
- When the windscreen is dirty or cloudy.
- When you drive in the shadows of trees, buildings, etc.
- When your vehicle is towing a trailer*.
- When you drive on a wet road surface following another vehicle.
 - ▶ The camera may perceive the tyre tracks in the water as lane lines.
- When there is snow or wheel tracks on the side of the road.
- When the road has many repaired area or an erased lane line.
- When the vehicle is running over painted signs or crosswalk markings.
- When you drive in a lane with worn-out lane markings.

📷 Lane Departure Warning Camera

If the **Can Not Operate:**  message appears:

- Use the climate control system to cool down the interior and, if necessary, the demister mode when windows are fogged.
- Start driving the vehicle to lower the windscreen temperature, which cools down the area around the Lane Departure Warning camera.

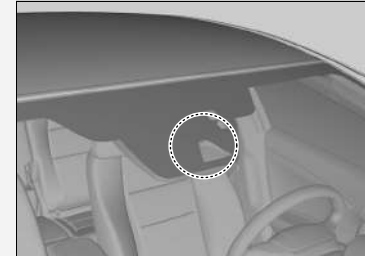

If the **Can Not Operate:**  message appears:

Park your vehicle in a safe place. Wipe away debris blocking the windscreen, then start driving again. If the message remains on even after driving for a while with the clean windscreen, have your vehicle checked by a dealer.

* Not available on all models

Traffic Sign Recognition System *

Reminds you of road sign information, such as the current speed limit and that overtaking is prohibited, your vehicle has just passed through, showing it on the i-multi-information display.

How the System Works

When the camera located behind the rearview mirror captures traffic signs while driving, the system displays the ones that are recognised as designated for your vehicle. The sign icon will be displayed for a while, then until the vehicle reaches a predetermined time and distance.

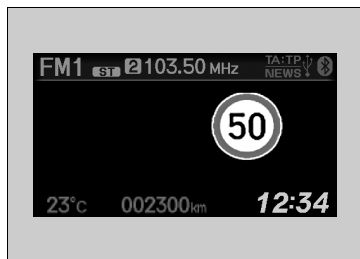

The sign icon also may switch to another one, or disappear when:

- The end of speed limit or other designated limit is detected.
- Your vehicle enters/exits motorway or highway.
- You make a turn with a turn signal to change direction at an intersection.

Traffic Sign Recognition System *

The system is designed to detect signs that follow the Vienna Convention standards. Not all signs may be displayed, but any signs posted on roadsides should not be ignored.

The Traffic Sign Recognition System is designed to merely provide driving assistance. The driver must still be aware of the road conditions and comply with all road regulations. Certain conditions, such as below, may disrupt the system's proper operations.

- The upper part of the windscreen is fogged or frosted, or is blocked by dirt, mud, leaves, wet snow, etc.
- Dew condensation is formed on the windscreen.

While driving, in addition to when there is no detected sign, you may also see the below screen when.

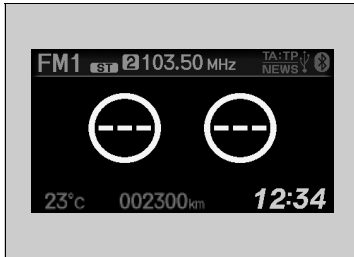

Condition

- The sign is covered with dirt, snow, or frost.
- The ambient brightness is too dark.
- In bad weather (heavy rain, fog, snow, etc.)
- Faded signs
- Signs positioned on bends
- Rotated or damaged signs
- Concealed or poorly positioned signs
- When the windscreen is blocked by dirt, mud, leaves, wet snow, etc.
- When the temperature inside the system is high.
- A sudden change between light and dark such as an entrance or exit of a tunnel.
- You drive into the sunlight (e.g. at dawn or dusk).
- When the windscreen is dirty or cloudy.
- When you drive in the shadows of trees, buildings, etc.

* Not available on all models

Continued

▶▶ Traffic Sign Recognition System *

If the **Can Not Operate:**  message appears:

- Use the climate control system to cool down the interior and, if necessary, the demister mode when windows are fogged.
- Start driving the vehicle to lower the windscreen temperature, which cools down the area around the system camera.

If the **Can Not Operate:**  message appears:

Park your vehicle in a safe place. Wipe away debris blocking the windscreen, then start driving again. If the message remains on even after driving for a while with the clean windscreen, have your vehicle checked by a dealer.

If the  appears in amber on the i-multi-information display while driving, the system may have malfunctioned.

Have your vehicle checked by a dealer.

In a situation above, you may also see this icon. The system is temporarily cancelled.



■ Signs Displayed on the i-Multi-Information Display

Two traffic signs can be simultaneously displayed next to each other when detected. The speed limit sign icon is displayed on the right half of the screen. The overtaking prohibition sign icon appears on the left. Any additional sign that indicates speed limit based on weather (rain, snow, etc.) or specific period of time can appear on either side.

■ When main mode is selected



Overtaking Prohibition Sign*1
Speed Limit Sign

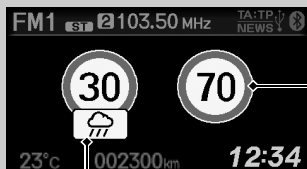

Additional Speed Limit Sign Based on Conditions*2
Speed Limit Sign

■ When main mode is not selected

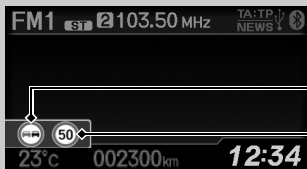

Overtaking Prohibition Sign*1
Speed Limit Sign

Depending on situation, *1 can be replaced with *2, or *2 can appear on the right side.

■ **Selecting to display traffic signs when main mode is off**

You can continue displaying reduced-size traffic sign icon on the i-multi-information display even while the main mode is not selected.

📄 **Customized Features** P. 131

Vehicle Stability Assist (VSA) System

Helps to stabilise the vehicle during cornering if the vehicle turns more or less than what was intended. It also assists in maintaining traction on slippery surfaces. It does so by regulating engine output and selectively applying the brakes.

■ VSA Operation

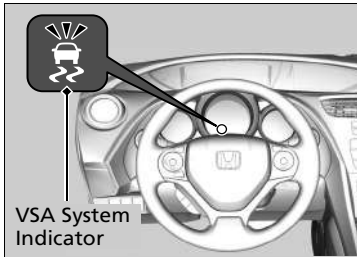

When VSA activates, you may notice that the engine does not respond to the accelerator. You may also notice some noise from the hydraulic system. You will also see the indicator blink.

▣ Vehicle Stability Assist (VSA) System

The VSA may not function properly if tyre types and sizes are mixed. Make sure to use the same size and type of tyre, and the air pressures are as specified.

When the VSA indicator comes on and stays on while driving, there may be a problem with the system. While this may not interfere with normal driving, have your vehicle checked by a dealer immediately.

VSA cannot enhance stability in all driving situations and does not control the entire braking system. You still need to drive and corner at speeds appropriate for the conditions and always leave a sufficient margin of safety.

VSA On and Off

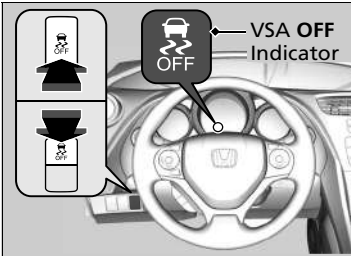

This button is on the driver side control panel. To turn the VSA system on and off, press and hold it until you hear a beep.

VSA stops and the indicator comes on.

To turn it on again, press the  (VSA **OFF**) button until you hear a beep.

VSA is turned on every time you start the engine, even if you turned it off the last time you drove the vehicle.

Vehicle Stability Assist (VSA) System

Without VSA, your vehicle will have normal braking and cornering ability, but it will not have VSA traction and stability enhancement.

In certain unusual conditions when your vehicle gets stuck in shallow mud or fresh snow, it may be easier to free it with VSA temporarily switched off.

When the VSA system is off, the traction control system is also off. You should only attempt to free your vehicle with VSA off if you are not able to free it when the system is on.

Immediately after freeing your vehicle, be sure to switch VSA on again. We do not recommend driving your vehicle with the VSA and traction control systems switched off.

You may hear a motor sound coming from the engine compartment while system checks are being performed immediately after starting the engine or while driving. This is normal.

Agile Handling Assist System

Lightly brakes the front wheels, as needed, when you turn the steering wheel, and helps support the vehicle's stability and performance during cornering.

ⓘ Agile Handling Assist System

The agile handling assist system cannot enhance stability in all driving situations. You still need to drive and corner at speeds appropriate for the conditions and always leave a sufficient margin of safety.

When the VSA system indicator comes on and stays on while driving, the agile handling assist system does not activate.

You may hear a sound coming from the engine compartment while the system is activated. This is normal.

Blind Spot Information System*

Is designed to detect vehicles in specified alert zones adjacent to your vehicle, particularly in harder to see areas commonly known as “blind spots.”

Blind Spot Information System*

⚠ WARNING

Failure to visually confirm that it is safe to change lanes before doing so may result in a crash and serious injury or death.

Do not rely only on the blind spot information system when changing lanes.

Always look in your mirrors, to either side of your vehicle, and behind you for other vehicles before changing lanes.

Important Safety Reminder

Like all assistance systems, blind spot information system has limitations. Over reliance on blind spot information system may result in a collision.

* Not available on all models

Continued

■ How the system works

- Radar sensors detect a vehicle in the alert zone when your vehicle is moving forward at 20 km/h (12 mph) or faster.

Alert zone range

- A: Approx. 0.5 m (1.6 ft.)
- B: Approx. 3 m (10 ft.)
- C: Approx. 3 m (10 ft.)

Radar Sensors:
underneath the
rear bumper
corners

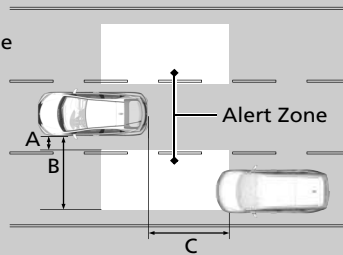

▣ Blind Spot Information System*

You can change the setting for blind spot information system.

▣ **Customized Features** P. 131

Turn the system off when towing a trailer*. The system may not work properly for the following reasons:

- The added mass tilts the vehicle and changes the radar coverage.
- The trailer itself can be detected by the radar sensors, causing the blind spot information system alert indicators to come on.

The system is for your convenience only. Even if an object is within the alert zone, the following situations may occur.

- The blind spot information system alert indicator may not come on due to obstruction (splashes, etc.) even without the  MID appearing.
- The blind spot information system alert indicator may come on even with the message appearing.

The blind spot information system alert indicator may not come on under the following conditions:

- A vehicle does not stay in the alert zone for more than two seconds.
- A vehicle is parked in a side lane.
- The speed difference between your vehicle and the vehicle you are passing is greater than 10 km/h (6 mph).
- An object not detected by the radar sensors approaches or passes your vehicle.
- A vehicle running in the adjacent lane is a motorcycle or other small vehicle.

The system does not operate when in **[R]**.

■ When the system detects a vehicle

Blind Spot Information Alert Indicator:
Located near the outside rearview mirror on both sides.

■ Comes on when

- A vehicle enters the alert zone from behind to overtake you with a speed difference of no more than 50 km/h (31 mph) from your vehicle.
- You pass a vehicle with a speed difference of no more than 20 km/h (12 mph).

■ Blinks and the beeper sounds when

You move the turn signal lever in the direction of the detected vehicle. The beeper sounds three times.

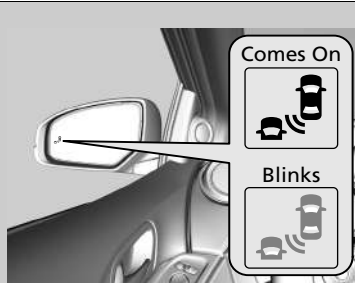

▣ Blind Spot Information System*

Blind spot information system may be adversely affected when:

- Objects (guard rails, poles, trees, parked vehicles, building, wall, etc) are detected.
- An object that does not reflect radio waves well, such as a motorcycle, is in the alert zone.
- Driving on a curved road.
- A vehicle is moving from a far lane to the adjacent lane.
- The system picks up external electrical interference.
- The rear bumper or the sensors have been improperly repaired or the rear bumper has been deformed.
- The orientation of the sensors has been changed.
- In bad weather (rain, snow, and fog).
- Driving on a bumpy road.
- Making a short turn that slightly tilts the vehicle.

For proper blind spot information system use:

- Always keep the rear bumper corner area clean.
- Do not cover the rear bumper corner area with labels or stickers of any kind.
- Take your vehicle to a dealer if you need the rear bumper corner area or the radar sensors to be repaired, or the rear bumper corner area is strongly impacted.

* Not available on all models

Deflation Warning System

Instead of directly measuring the pressure in each tyre, the deflation warning system on this vehicle monitors and compares the rolling radius and rotational characteristics of each wheel and tyre while you are driving to determine if one or more tyres are significantly under-inflated. This will cause the low tyre pressure/deflation warning system indicator to come on and a message to appear on the i-multi-information display.

Deflation Warning System Calibration

You must start deflation warning system calibration every time you:

- Adjust the pressure in one or more tyres.
- Rotate the tyres.
- Replace one or more tyres.

Before calibrating the deflation warning system:

- Set the cold tyre pressure in all four tyres.

Make sure:

- The vehicle is at a complete stop.

Manual transmission models

- The parking brake is applied.

Automatic transmission models

- The shift lever is in **P**.

All models

- The ignition switch is in ON **II***1.

*1: Models with the keyless access system have an **ENGINE START/STOP** button instead of an ignition switch.

Deflation Warning System

The system does not monitor the tyres when driving at low speed.

Conditions such as low ambient temperature and altitude change directly affect tyre pressure and can trigger the low tyre pressure/deflation warning system indicator to come on.

Tyre pressure checked and inflated in:

- Warm weather can become under-inflated in colder weather.
- Cold weather can become over-inflated in warmer weather.

The low tyre pressure indicator will not come on as a result of over inflation.

The deflation warning system may not function properly if tyre type and size are mixed.

Make sure to use the same size and type of tyre.

📖 **Checking and Maintaining Tyres** P. 534

The low tyre pressure/deflation warning system indicator may come on with a delay or may not come on at all when:

- You rapidly accelerate, decelerate, or turn the steering wheel.
- You drive on snowy or slippery roads.
- Snow chains are used.

The low tyre pressure/deflation warning system indicator may come on under the following conditions:

- A compact spare tyre* is used.
- There is a heavier and uneven load on the tyres, such as when towing a trailer, than the condition at calibration.
- Snow chains are used.

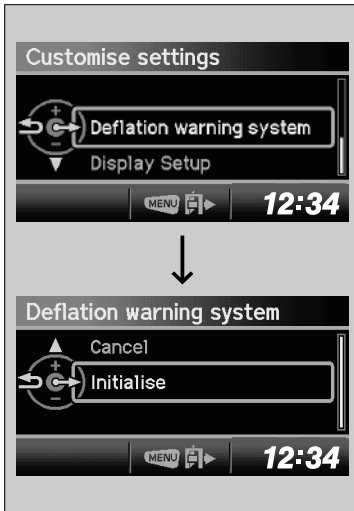

You can calibrate the system from the customized features on the i-multi-information display.

1. Press the **MENU** button.
2. Press the **+** or **-** button to select **Customise settings**.
3. Press the **+** or **-** button to select **Deflation warning system**.
4. Press the **+** or **-** button and select **Initialise**.
 - The display returns to the normal screen.
 - The calibration process finishes automatically.

Deflation Warning System Calibration

- Deflation Warning System cannot be calibrated if a compact spare tyre* is installed.
- The calibration process requires approximately 30 minutes of cumulative driving at speeds between 40–100 km/h (25–62 mph).
- During this period, if the ignition is turned on and the vehicle is not moved within 45 seconds, you may notice the low tyre pressure indicator comes on briefly. This is normal and indicates that the calibration process is not yet complete.

If the snow chains are installed, remove them before calibrating the deflation warning system.

If the low tyre pressure/deflation warning system indicator comes on even when the properly inflated specified regular tyres are installed, have your vehicle checked by a dealer.

We recommend that the tyres be replaced with the same brand, model, and size as the originals. Ask a dealer for details.

* Not available on all models

Brake System

Parking Brake

Use the parking brake to keep the vehicle stationary when parking.

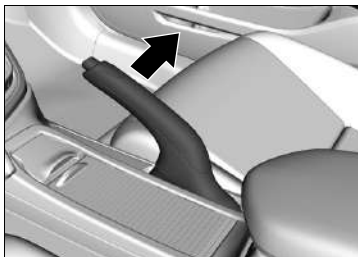

To apply:

Pull the lever fully up without pressing the release button.

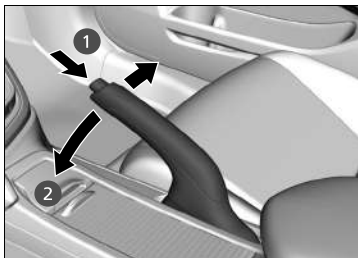

To release:

1. Pull the lever slightly, and press and hold the release button.
2. Lower the lever down all the way, then release the button.

Parking Brake

NOTICE

Release the parking brake fully before driving. The rear brakes and axle can be damaged if you drive with the parking brake applied.

If you start driving without fully releasing the parking brake, a buzzer sounds as a warning, and  appears on the i-multi-information display.

Always apply the parking brake when parking.

■ Foot Brake

Your vehicle is equipped with disc brakes at all four wheels. A vacuum power assist helps to reduce the effort needed on the brake pedal. The brake assist system increases the stopping force when you depress the brake pedal hard in an emergency situation. The anti-lock brake system (ABS) helps you retain steering control when braking very hard.

➤ **Brake Assist System** P. 433

➤ **Anti-lock Brake System (ABS)** P. 432

2.0 L engine models

■ Brake squeal

To satisfy the performance under a wide range of driving conditions, a high-performance braking system is equipped on your vehicle. You may hear the brake squeal under certain conditions, such as vehicle speed, deceleration, humidity, and so on. This is not a malfunction.

☒ Foot Brake

Check the brakes after driving through deep water, or if there is a buildup of road surface water. If necessary, dry the brakes by lightly depressing the pedal several times.

If you hear a continuous metallic friction sound when applying the brakes, the brake pads need to be replaced. Have your vehicle checked by a dealer.

Constantly using the brake pedal while going down a long hill builds up heat, which reduces the brake effectiveness. Apply engine braking by taking your foot off the accelerator pedal and downshifting to a lower gear. With manual transmission use a lower gear for greater engine braking.

Do not rest your foot on the brake pedal while driving, as it will lightly apply the brakes and cause them to lose effectiveness over time and reduce pad life. It will also confuse drivers behind you.

Anti-lock Brake System (ABS)

■ ABS

Helps to prevent the wheels from locking up, and helps you retain steering control by pumping the brakes rapidly, much faster than you.

The electronic brake distribution (EBD) system, which is part of the ABS, also balances the front-to-rear braking distribution according to vehicle loading.

You should never pump the brake pedal. Let the ABS work for you by always keeping firm, steady pressure on the brake pedal. This is sometimes referred to as “stomp and steer.”

■ ABS operation

The brake pedal may pulsate slightly when the ABS is working. Keep holding the pedal firmly down. On dry pavement, you will need to press on the brake pedal very hard before the ABS activates. However, you may feel the ABS activate immediately if you are trying to stop on snow or ice.

When the vehicle speed goes under 10 km/h (6 mph), the ABS stops.

⚠ Anti-lock Brake System (ABS)

NOTICE

The ABS may not function correctly if you use an incorrect tyre type and size.

When the **ABS** indicator comes on while driving, there may be a problem with the system. While normal braking is not affected, there is a possibility of the ABS not operating. Have your vehicle checked by a dealer immediately.

The ABS does not reduce the time or distance it takes to stop the vehicle. It only helps with steering control during hard braking.

In the following cases, your vehicle may need more stopping distance than a vehicle without the ABS:

- When driving on rough road surfaces, including when driving on uneven surfaces, such as gravel or snow.
- When tyre chains are installed.

You may hear a motor sound coming from the engine compartment while system checks are being performed immediately after starting the engine or while driving. This is normal.

Brake Assist System

■ Brake Assist System

Designed to assist the driver by generating greater braking force when you depress the brake pedal hard during emergency braking.

■ Brake assist system operation

Depress the brake pedal firmly for more powerful braking.

When brake assist operates, the pedal may wiggle slightly and an operating noise may be heard. This is normal. Keep holding the brake pedal firmly down.

City-Brake Active system*

Can assist you when driving at a low speed, and there is a possibility of your vehicle colliding with a vehicle detected right in front of yours. The City-Brake Active system is designed to alert you when a potential collision is determined, as well as to reduce your vehicle speed when a collision is deemed unavoidable to help to minimise collision severity.

How the System Works

A laser sensor starts to monitor if there is a vehicle in front of you when your vehicle speed is between about 5 km/h (3 mph) and about 32 km/h (20 mph).

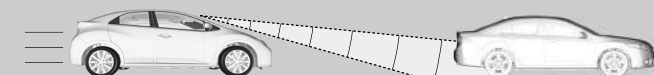

Laser Sensor

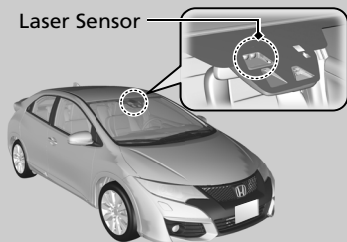

The laser sensor is behind the rearview mirror.

The system activates when the speed difference between your vehicle and a vehicle detected in front of you is about 5 km/h (3 mph) to 32 km/h (20 mph) with a high chance of collision.

The system don't activate when shift position is **R**.

City-Brake Active system*

WARNING

Do not rely on the city-brake active system to avoid every possible frontal collision.

Failure to pay close attention to a vehicle ahead of you, and to operate the brake pedal appropriately according to the situation can cause serious injury or death.

For the system to work properly:

- Always keep the upper part of the windscreen clean. Wipe away any dirt, ice, frost, etc.
- Do not impact the area around the laser sensor when cleaning the windscreen.
- Do not remove the laser sensor from the unit.

Manual transmission models

When the vehicle comes to a stop with the system's automatic braking, the engine may stop. To start the engine again, follow the standard procedure.

► **Starting the Engine** P. 382, 385

Collision Alert Stages

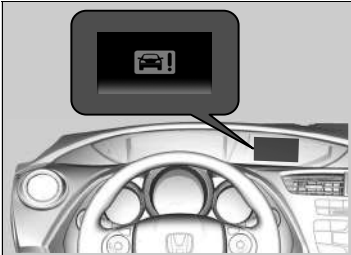

The beeper sounds, and a CTBA warning blinks on the i-multi-information display, and hard braking is applied when a possible collision becomes likely unavoidable.

This automatic braking with the system activated is cancelled after the vehicle comes to a complete stop.

Apply the brakes accordingly.

A message indicating that the system has activated appears on the i-multi-information display after the vehicle is stopped.

📄 i-Multi-Information Display Warning and Information Messages P. 103

The system may be cancelled if you operate the brake pedal, the accelerator pedal, or the steering wheel to avoid the collision.

📄 City-Brake Active system*

The system may not activate or may not detect a vehicle in front of your vehicle under the following conditions:

- A vehicle in front of you is diagonally, horizontally, or frontally positioned.
- The distance between your vehicle and the vehicle ahead of you is too short.
- The speed difference between your vehicle and a vehicle ahead of you is large.
- A vehicle cuts in front of you, and brakes suddenly.
- You rapidly accelerate your vehicle, getting closer to a vehicle ahead.
- An oncoming vehicle suddenly drifts in front of you.
- Your vehicle suddenly drifts into the oncoming lane.
- A vehicle suddenly crosses in front of you at intersections.
- When driving in bad weather (heavy rain, fog, snow, etc.).
- When driving on a curved or winding road.
- A vehicle in front of you is extremely dirty, making it difficult to reflect radio waves well.
- You depress the brake pedal or turn the steering wheel to avoid a collision.
- A vehicle ahead of you is a motorcycle or other small vehicle the sensor cannot detect properly.
- The upper part of the windscreen around the laser sensor is covered with dirt, ice frost, etc.

The system may not activate while you are fully depressing the accelerator pedal.

* Not available on all models

Continued

■ The System On and Off

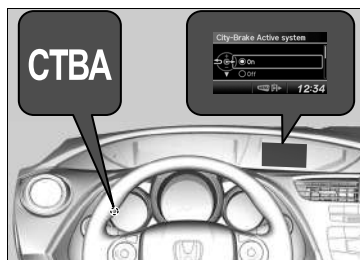

You can turn the system on and off using the i-multi-information display.

➤ **Customized Features** P. 131

When the system is off, the **CTBA** indicator in the instrument panel comes on.

City-Brake Active system is turned on every time you turn the ignition switch to ON **II***¹, even if you turned it off the last time you drove the vehicle.

☒ City-Brake Active system*

The system may automatically shut off, and the **CTBA** indicator can come on and the message can appear on the i-multi-information display when:

- The temperature around the laser sensor on the upper part of the windscreen becomes high.
- The area around the laser sensor, which is located in the upper part of the windscreen, is covered with obstacles, such as dirt, ice and frost.
- The bonnet is covered with obstacles such as snow.

Stop your vehicle in a safe place, and

- Use the air conditioning system to cool down the interior if the laser sensor temperature is high.
- Remove any obstacles such as dirt and snow from the windscreen and bonnet.

➤ **Indicators** P. 82

Once the conditions that caused the system to shut off improve, the system comes back on.

Turn off the system when:

- You use a dynamometer or put the wheels on a roller.
- Driving off road or on a mountainous road obstructed with branches and leaves.

*1: Models with the keyless access system have an **ENGINE START/STOP** button instead of an ignition switch.

* Not available on all models

■ With Little Chance of a Collision

The system may activate even when you are aware of a vehicle ahead of you, or when there is no vehicle ahead. Some examples of this are:

■ When passing

Your vehicle approaches another vehicle ahead of you and you change lanes to pass.

■ At an intersection

Your vehicle approaches or passes another vehicle that is making a left or right turn.

■ Through a low bridge

You drive under a low or narrow bridge.

■ Speed bumps, road work sites, train tracks, roadside objects, etc.

You drive over speed bumps, steel road plates, etc., or your vehicle approaches train tracks or roadside objects, such as a traffic sign and guard rail, on a curve.

■ When parking

Your vehicle approaches a stationary vehicle or wall.

▣ City-Brake Active system*

Take your vehicle to a dealer if you need the laser sensor or area around it to be repaired, or removed, or the area around the laser sensor is strongly impacted.

Do not alter your vehicle's suspension. Changing the vehicle height prevents the system to work properly.

Make sure to use the same size and type of tyre for all four wheels. Use the tyres that are all in about the same condition with adequate tread. If not, the system may operate abnormally.

The system may not work properly if:

- Your vehicle has heavy load in the rear.
- Tyres are over- or underinflated.

* Not available on all models

About the Laser Equipped in the System

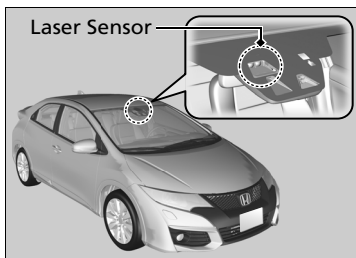

The City-Brake Active system unit, including the laser sensor, is located behind the rearview mirror.

Following lists the classified specifications of the laser used in this system according to the IEC requirements. The same information can be found in the IEC60825-1 standard labels.

Laser classification

Max average power:	45 mW
Pulse duration:	33 ns
Wavelength:	905 nm
Average power angle (horizontal × vertical)	28 × 12

Laser Classification Label

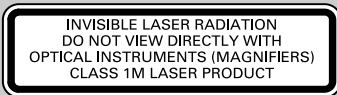

Laser Explanation Label

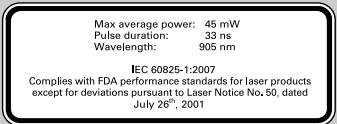

City-Brake Active system*

⚠ WARNING

Handling the laser sensor improperly can lead to eye injury.

To avoid eye injury, Keep the following:

- Do not take the sensor apart from the unit.
- Never look at the sensor within a 100 mm distance using an optical device, such as a magnified glass, microscopes, and an object lens.

1.4 L engine, 1.8 L engine, and diesel engine models

Emergency Stop Signal

Activates when you brake hard while driving at 60 km/h or above to alert drivers behind you about sudden braking by rapidly flashing hazard warning lights. This may help to alert drivers behind you to take appropriate means to avoid a possible collision with your vehicle.

■ When the system activates:

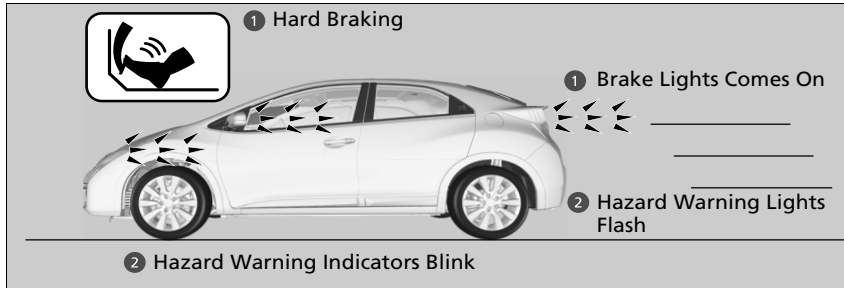

The hazard warning lights stop flashing when:

- You release the brake pedal.
- The ABS is deactivated.
- Your vehicle's decelerating speed becomes moderate.
- You press the hazard warning button.

☒ Emergency Stop Signal

The emergency stop signal is not a system that can prevent a possible rear-end collision caused by your hard braking. It flashes the hazard warning lights at the time you are braking hard. It is always recommended to avoid hard braking unless it is absolutely necessary.

The emergency stop signal does not activate with the hazard warning button pressed in.

If the ABS stops working for a certain period of the during braking, the emergency stop signal may not activate at all.

When Stopped

Automatic transmission models

1. Depress the brake pedal firmly with the shift lever in **D**.
2. Apply the parking brake while holding the brake pedal down.
3. Move the shift lever to **P**.
4. Turn off the engine.

Manual transmission models

1. Stop the vehicle completely.
2. Apply the parking brake while holding the brake pedal down.
3. Change the shift lever to **N**.

Diesel models

4. Keep idling the engine for about 10 seconds.

All models

5. Turn off the engine.
6. Change the shift lever to **1** or **R** for locking the gear.

Always set the parking brake firmly, in particular if you are parked on an incline.

» Parking Your Vehicle

Do not park your vehicle near flammable objects, such as dry grass, oil, or timber. Heat from the exhaust can cause a fire.

» When Stopped

Automatic transmission models

NOTICE

The following can damage the transmission:

- Depressing the accelerator and brake pedals simultaneously.
- Holding the vehicle in place when facing uphill by depressing the accelerator pedal.
- Moving the shift lever into **P** before the vehicle stops completely.

Diesel models

Keep idling the engine for a few minutes if your vehicle has towed a trailer.

The engine idling may be prohibited in some countries. Check and follow your local legal requirements.

All models

In extremely cold temperatures, the parking brake may freeze up if applied. If such temperatures are expected, do not apply the parking brake but, if parking on a slope, either turn the front wheels so they will contact the curb if the vehicle rolls down the slope or block the wheels to keep the vehicle from moving. If you do not take either precaution, the vehicle may roll unexpectedly, leading to a crash.

Parking Sensor System*

The corner and centre sensors monitor obstacles behind your vehicle, and the beeper and i-multi-information display let you know the approximate distance between your vehicle and the obstacle.

■ The sensor location and range

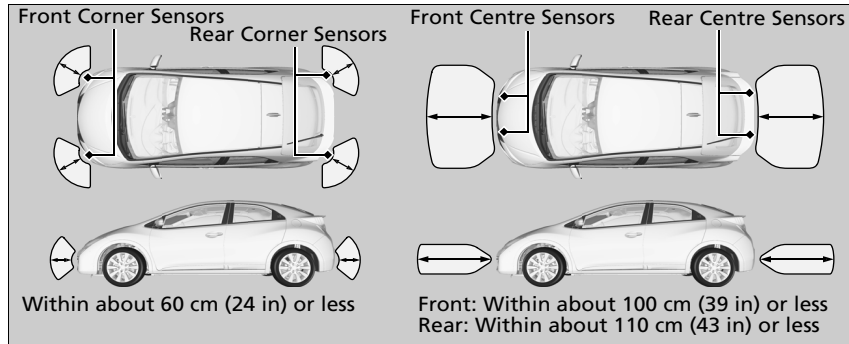

▣ Parking Sensor System*

Even when the system is on, always confirm if there is no obstacle near your vehicle before parking.

The system may not work properly when:

- The sensors are covered with snow, ice, mud or dirt.
- The vehicle is on uneven surface, such as grass, bumps, or a hill.
- The vehicle has been out in hot or cold weather.
- The system is affected by devices that emit ultrasonic waves.
- Driving in bad weather.

The system may not sense:

- Thin or low objects.
- Sonic-absorptive materials, such as snow, cotton, or sponge.
- Objects directly under the bumper.

Do not put any accessories on or around the sensors.

* Not available on all models

Continued

■ Parking sensor system on and off

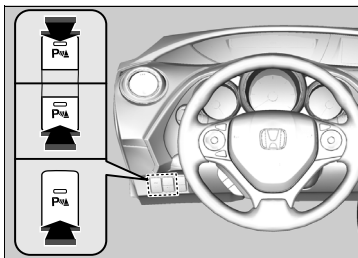

With the ignition switch in ON **[II]***1, press the parking sensor system button to turn on or off the system. The indicator in the button comes on when the system is on.

The front corner and front centre sensors start to detect an obstacle when the shift lever is in any position other than **[P]** or **[R]**, and the vehicle speed is less than 8 km/h (5 mph).

The front corner, rear corner and rear centre sensors start to detect an obstacle when the shift lever is in **[R]**, and the vehicle speed is less than 8 km/h (5 mph).

Manual transmission models

You also need to release the parking brake.

☒ Parking sensor system on and off

When you turn the ignition switch to ON **[II]***1, the system will be in the previously selected condition.

*1: Models with the keyless access system have an **ENGINE START/STOP** button instead of an ignition switch.

*1: Models with the keyless access system have an **ENGINE START/STOP** button instead of an ignition switch.

Models without navigation system

■ When the distance between your vehicle and obstacles behind becomes shorter

Length of the intermittent beep	Distance between the bumper and obstacle		Indicator	i-Multi-information display
	Corner sensors	Centre sensors		
Moderate	—	Front: About 100-60 cm (39-24 inches) Rear: About 110-60 cm (43-24 inches)	Blinks in yellow* ¹	<div data-bbox="1141 324 1484 352" data-label="Section-Header"> <p>Models without rearview camera</p> </div> <div data-bbox="1228 369 1396 464" data-label="Image"> </div> <div data-bbox="1157 470 1444 520" data-label="Text"> <p>Indicators light where the sensor detects an obstacle.</p> </div>
Short	About 60-45 cm (24-18 inches)	About 60-45 cm (24-18 inches)	Blinks in amber	<div data-bbox="1165 548 1460 576" data-label="Section-Header"> <p>Models with rearview camera</p> </div> <div data-bbox="1228 582 1396 688" data-label="Image"> </div> <div data-bbox="1157 694 1444 744" data-label="Text"> <p>Indicators light where the sensor detects an obstacle.</p> </div>
Very short	About 45-35 cm (18-14 inches)	About 45-35 cm (18-14 inches)		
Continuous	About 35 cm (14 inches) or less	About 35 cm (14 inches) or less	Blinks in red	

*1: At this stage, only the centre sensors detect obstacles.

Models with navigation system

■ When the distance between your vehicle and obstacles behind becomes shorter

Length of the intermittent beep	Distance between the bumper and obstacle		Indicator	i-Multi-information display
	Corner sensors	Centre sensors		
Moderate	—	Front: About 100-60 cm (39-24 inches) Rear: About 110-60 cm (43-24 inches)	Blinks in yellow*1	 <p>Indicators light where the sensor detects an obstacle.</p>
Short	About 60-45 cm (24-18 inches)	About 60-45 cm (24-18 inches)	Blinks in amber	
Very short	About 45-35 cm (18-14 inches)	About 45-35 cm (18-14 inches)		
Continuous	About 35 cm (14 inches) or less	About 35 cm (14 inches) or less	Blinks in red	

*1: At this stage, only the centre sensors detect obstacles.

■ Rearview screen with parking sensor

When the distance between your vehicle and obstacle behind becomes shorter, the navigation system's rearview screen displays the parking sensor indicators simultaneously.

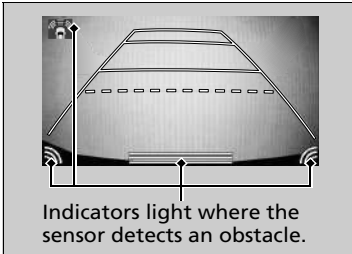

The indicators on the navigation screen change colour, and blink the same as the indicators on the i-multi-information display.

■ Turning off All Rear Sensors

1. Make sure that the parking sensor system is not activated. Turn the ignition switch to LOCK **[0]***1.
2. Press and hold the parking sensor system button, and turn the ignition switch to ON **[II]***1.
3. Keep pressing the button for 10 seconds. Release the button when the indicator in the button blinks.
4. Press the button again. The indicator in the button goes off.
 - ▶ The beeper sounds twice. The rear sensors are now turned off.

To turn the rear sensors on again, follow the above procedure. The beeper sounds three times when the rear sensors come back on.

*1: Models with the keyless access system have an **ENGINE START/STOP** button instead of an ignition switch.

☒ Turning off All Rear Sensors

When you shift to **[R]**, the indicator in the parking sensor system button blinks as a reminder that the rear sensors have been turned off.

Cross Traffic Monitor*

Monitors the rear corner areas using the radar sensors when reversing, and alerts you if a vehicle approaching from a rear corner is detected.

The system is convenient especially when you are getting out of a parking space backwards.

☒ Cross Traffic Monitor*

CAUTION

Cross traffic monitor is for your convenience only. The system cannot detect all approaching vehicles or avoid all possible collisions.

Failure to visually confirm that it is safe to reverse the vehicle before doing so may result in a collision. Do not rely only on the system's audible and visual alerts when reversing.

Do not solely rely on the system when reversing; always also use your mirrors, and look behind and to the sides of your vehicle before reversing.

The backup sensor system's alerting buzzer overrides the cross traffic monitor buzzer when the sensors are detecting obstacles at the closest range.

■ How the System Works

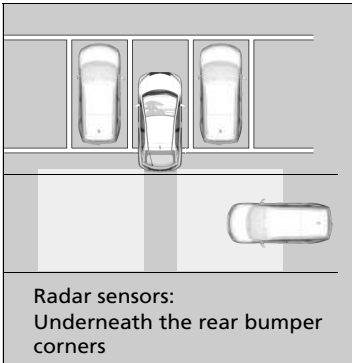

When a vehicle approaches from a rear corner, cross traffic monitor alerts you with a buzzer and a displayed warning.

The system activates when:

- Turn the ignition switch to ON **II***1.
- The Cross Traffic Monitor is turned on.
 - ▶ **Cross Traffic Monitor On and Off** P. 450
 - ▶ **Customized Features** P. 131, 313
- The shift lever is in **R**.

▶▶ Cross Traffic Monitor*

Cross traffic monitor may not detect or may delay detecting an approaching vehicle, or may alert detection without an approaching vehicle under the following conditions:

- An obstacle, such as another vehicle and a wall, near your vehicle's rear bumper, is blocking the radar sensor's scope.
- Your vehicle is moving at the speed of about 5 km/h (3 mph) or higher.
- A vehicle is approaching at the speed other than between about 10 km/h (6 mph) and 25 km/h (16 mph).
- The system picks up external interference such as other radar sensors from another vehicle or strong radio wave transmitted from a facility nearby.
- Either corner of the rear bumper is covered with snow, ice, mud or dirt.
- When there is bad weather.
- Your vehicle is on an incline.
- Your vehicle is tilted due to a heavy load in the rear.
- Your vehicle is reversing towards a wall, a pole, a vehicle, and so on.
- The rear bumper or the sensors have been improperly repaired or the rear bumper has been deformed.

▶ **Have a vehicle checked by a dealer.**

*1: Models with the keyless access system have an **ENGINE START/STOP** button instead of an ignition switch.

* Not available on all models

Continued

The system will not detect a vehicle that approaches from directly behind your vehicle, nor will it provide alerts about a detected vehicle when it moves directly behind your vehicle.

The system does not detect or provide alerts for a vehicle that is moving away from your vehicle, and it may detect or alert for pedestrians, bicycles, or stationary objects.

🗒️ Cross Traffic Monitor*

For proper operation, always keep the rear bumper corner area clean. Do not cover the rear bumper corner area with labels or stickers of any kind.

When the System Detects a Vehicle

Models without rearview camera

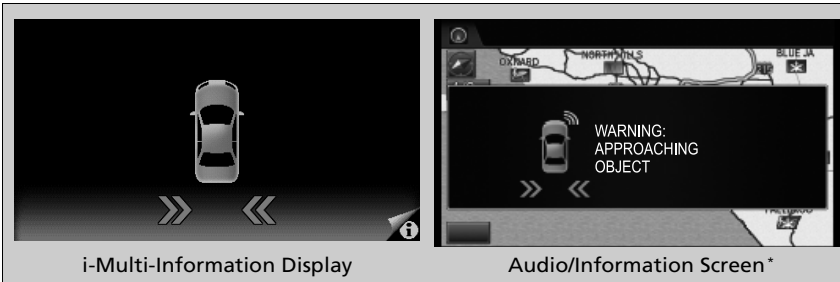

A warning icon appears on the i-multi-information display or the audio/information screen*.

Models with rearview camera

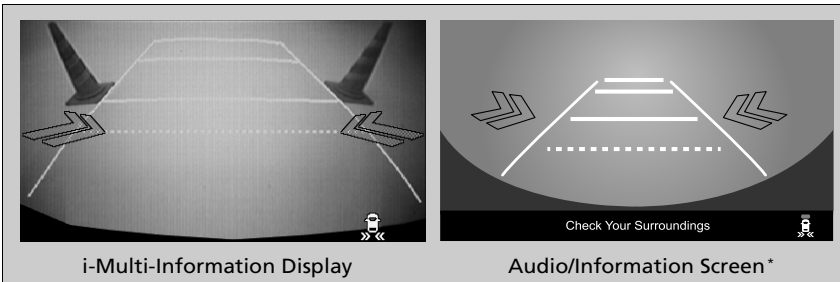

An arrow icon appears on the side a vehicle is approaching on the i-multi-information display or the audio/information screen*.

* Not available on all models

Continued

⊠ Cross Traffic Monitor*

You may see the following icon on the i-multi-information display under certain circumstances:

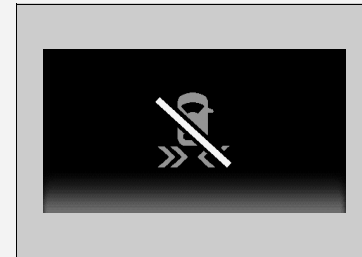

Indicates in amber that the rear bumper corners are covered with snow, mud, etc. The system is temporarily cancelled. Remove debris from the rear bumper corners.



Indicates in amber that there is a problem with the system. Have your vehicle checked by a dealer.

Cross Traffic Monitor On and Off



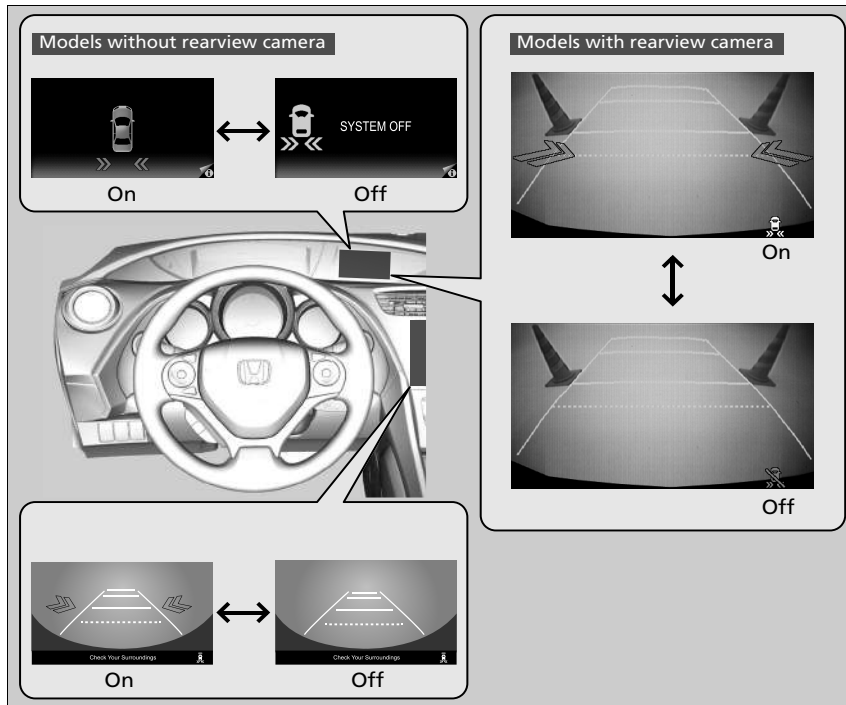

You can switch on and off the system using the i-multi-information display or the audio/information screen*.

➤ **Customized Features** P. 131, 1313



▶▶ Cross Traffic Monitor*

Models with rearview camera

If the  icon that usually appears on the lower right of the screen changes to  in amber when you shift to **R**, the rear bumper corners may be covered with snow, mud, etc. The system is temporarily cancelled. Remove debris from the rear bumper corners. If  changes to  in amber, there may be a problem with the system. Have your vehicle checked by a dealer.

About Your Rearview Camera

The i-multi-information display or the audio/information screen* can display your vehicle's rear view.

The display automatically changes to a rear view when the shift lever is moved to **[R]**.

Rearview Camera Display Area

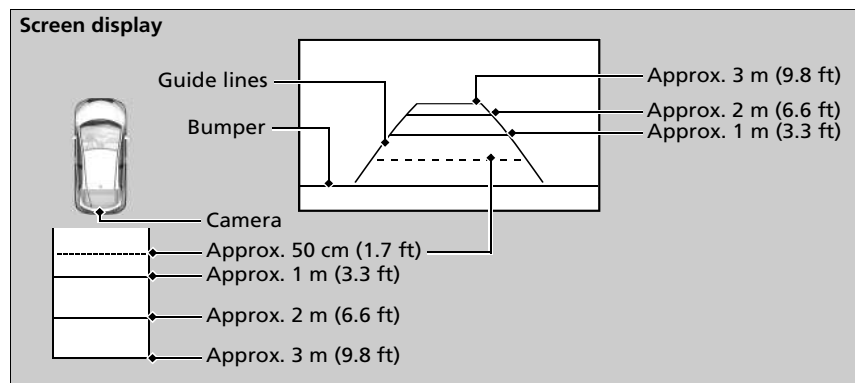

You can also change the rear camera setting by pressing the **MENU** button on the rear camera screen. When you press the **MENU** button and select **Display**, the following items are available in additional:

- **Display** tab: Adjusts **Brightness**, **Contrast**, and **Black Level** of the rear camera screen.
- **Colour** tab: Adjusts **Colour** and **Tint** of the rear camera screen.

About Your Rearview Camera

The view provided by the rear camera is restricted. You cannot see the corner ends of the bumper and what is underneath the bumper. Its unique lens also makes objects appear closer or farther than they actually are.

Visually confirm that it is safe to drive before reversing. Certain conditions (such as weather, lighting, and high temperatures) may also restrict the rear view. Do not rely on the rearview display which does not give you all information about conditions at the back of your vehicle.

Models with two displays

If the camera lens is covered with dirt, or moisture, use a soft, moist cloth to keep the lens clean and free of debris.

You can change the **Fixed Guideline** and **Dynamic Guideline** settings.

➤ **Customized Features** P. 313

Fixed Guideline

On: Guidelines appear when you shift into **[R]**.

Off: Guidelines do not appear.

Dynamic Guideline

On: Guidelines move according to the steering wheel direction.

Off: Guidelines do not move.

* Not available on all models

Petrol models

Fuel Information

■ Fuel recommendation

Premium unleaded petrol, research octane number 95 or higher

Your vehicle is designed to operate on premium unleaded petrol with a research octane of 95 or higher. If this octane grade is unavailable, regular unleaded petrol with a research octane of 91 or higher may be used temporarily. Use of regular unleaded petrol can cause metallic knocking noises in the engine and will result in decreased engine performance. The long-term use of regular-grade petrol can lead to engine damage.

■ Fuel tank capacity: 50 litres

» Fuel Information

NOTICE

Use of petrol that contains lead presents the following risks:

- Damage to the exhaust system including the catalytic converter
- Damage to the engine and fuel system
- Detrimental effects on the engine and other systems

Oxygenated Fuels

Oxygenated fuels are blended with petrol and ethanol or ether compound. Your vehicle is also designed to operate on oxygenated fuels containing up to 10 % ethanol by volume and up to 22 % ETBE by volume, based on the EN 228 standards. Consult a dealer for more information.

Diesel models

Fuel Information

■ Fuel recommendation

EN 590 standard diesel fuel

Select the proper clean fuel of good quality according to the regional and climate condition. Use of improper fuel can reduce engine power.

■ Fuel tank capacity: 50 litres

☒ Fuel Information

NOTICE

Serious damage may occur if petrol is used in diesel engines.

Your vehicle is not designed to use Biodiesel (pure or high concentration more than specified by EN590). Consult a dealer for more information.

Petrol models

How to Refuel

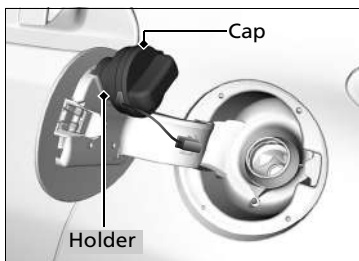
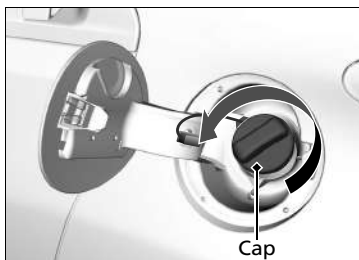
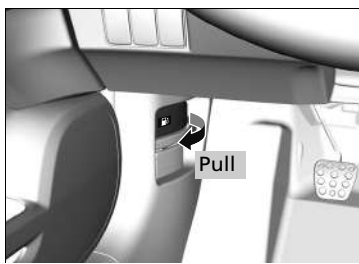

1. Stop your vehicle with the service station pump on the left side of the vehicle in the rear.
2. Turn off the engine.
3. Pull on the fuel fill door release handle under the driver's side lower outside corner of the dashboard.
 - ▶ The fuel fill door opens.
4. Remove the fuel fill cap slowly. If you hear a release of air, wait until this stops, then turn the knob slowly to open the fuel fill cap.
5. Place the fuel fill cap in the holder.
6. Insert the fuel filler nozzle fully.
 - ▶ When the tank is full, the filler nozzle will click off automatically. This leaves space in the fuel tank in case the fuel expands with a change in the temperature.
7. After filling, replace the fuel fill cap, tightening it until you hear it click at least once.
 - ▶ Shut the fuel fill door by hand.

▶ How to Refuel

⚠ WARNING

Petrol is highly flammable and explosive. You can be burned or seriously injured when handling fuel.

- Stop the engine, and keep heat, sparks, and flame away.
- Handle fuel only outdoors.
- Wipe up spills immediately.

Do not continue to add fuel after the filler nozzle has automatically stopped. Additional fuel can exceed the full tank capacity.

The filler nozzle automatically stops to leave space in the fuel tank so that fuel does not overflow as a result of changes in air temperature.

Diesel models

How to Refuel

Your fuel tank is not equipped with a fuel filler cap. You can insert the diesel fuel filler nozzle directly into the fuel filler neck. The tank seals itself again when you pull out the filler nozzle.

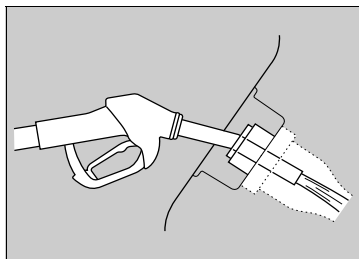
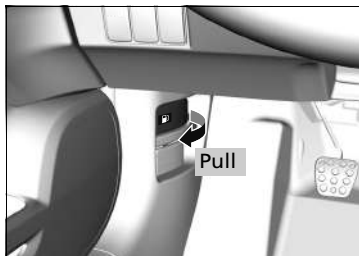

1. Stop your vehicle with the service station pump on the left side of the vehicle in the rear.
2. Turn off the engine.
3. Pull on the fuel fill door release handle under the driver's side lower outside corner of the dashboard.
 - ▶ The fuel fill door opens.
4. Insert the filler nozzle fully.
 - ▶ Keep the filler nozzle level.
 - ▶ When the tank is full, the filler nozzle will click off automatically.
 - ▶ After filling, wait about 10 seconds before removing the filler nozzle.
5. Shut the fuel fill door by hand.

How to Refuel

⚠ WARNING

Fuel is highly flammable and explosive. You can be burned or seriously injured when handling fuel.

- Stop the engine, and keep heat, sparks, and flame away.
- Handle fuel only outdoors.
- Wipe up spills immediately.

Only a service station diesel fuel filler nozzle can be used.

The filler nozzle automatically stops to leave space in the fuel tank so that fuel does not overflow as a result of changes in air temperature.

Do not continue to add fuel after the filler nozzle has automatically stopped. Additional fuel can exceed the full tank capacity.

If you have to refuel your vehicle from a portable container, use the funnel provided with the vehicle.

▶ **Refueling From a Portable Fuel Container**
P. 602

Improving Fuel Economy and Reducing CO₂ Emissions

Achieving fuel economy and reducing CO₂ emissions is dependent on several factors, including driving conditions, load weight, idling time, driving habits, and vehicle condition. Depending on these and other factors, you may not achieve the rated fuel economy of this vehicle.

Maintenance and Fuel Economy

You can optimize your fuel economy with proper maintenance of your vehicle. Always maintain your vehicle according to the service reminder symbols displayed on the i-multi-information display. On vehicles without service reminder system, follow the maintenance schedule in the service book that came with your vehicle. On vehicles without the service book, follow the maintenance schedule in this owner's manual. If necessary, consult your warranty booklet.

➤ Maintenance Schedule* P. 473

- Use engine oil with the viscosity recommended by the ACEA or API Certification Seal.
- Maintain the specified tyre pressure.
- Do not load the vehicle with excess luggage.
- Keep your vehicle clean. A buildup of snow or mud on your vehicle's underside adds weight and increases wind resistance.

➤ Improving Fuel Economy and Reducing CO₂ Emissions

Direct calculation is the recommended method to determine actual fuel consumed while driving.

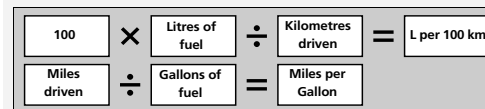

Accessories

When installing accessories, check the following:

- Do not install accessories on the windshield. They can obstruct your view and delay your reaction to driving conditions.
- Do not install any accessories over areas marked SRS Airbag, on the sides or backs of the front seats, on front or side pillars, or near the side windows. Accessories installed in these areas may interfere with proper operation of the vehicle's airbags or may be propelled into you or another occupant if the airbags deploy.
- Be sure electronic accessories do not overload electrical circuits or interfere with proper operation of your vehicle.
➤ **Fuses** P. 592
- Before installing any electronic accessory, have the installer contact a dealer for assistance. If possible, have a dealer inspect the final installation.

Modifications

Do not modify your vehicle or use non-Honda components that can affect its handling, stability, and reliability.

Overall vehicle performance can be affected. Always make sure all equipment is properly installed and maintained, and that it meets your country's and local regulations.

Accessories and Modifications

⚠ WARNING

Improper accessories or modifications can affect your vehicle's handling, stability, and performance, and cause a crash in which you can be seriously hurt or killed.

Follow all instructions in this owner's manual regarding accessories and modifications.

When properly installed, mobile phones, alarms, two-way radios, radio antennas, and low-powered audio systems should not interfere with your vehicle's computer controlled systems, such as your airbags and anti-lock brakes.

Honda Genuine accessories are recommended to ensure proper operation on your vehicle.

Maintenance

This chapter discusses basic maintenance.



Before Performing Maintenance

Inspection and Maintenance	460
Safety When Performing Maintenance..	461
Parts and Fluids Used in Maintenance Service	462

Service Reminder System*	463
---------------------------------------	-----

Oil Monitor System*	468
----------------------------------	-----

Maintenance Schedule*	473
------------------------------------	-----

Maintenance Under the Bonnet

Maintenance Items Under the Bonnet...	490
Opening the Bonnet	494

Petrol models

Recommended Engine Oil	495
------------------------------	-----

Diesel models

Recommended Engine Oil	497
------------------------------	-----

Oil Check	498
-----------------	-----

Adding Engine Oil	502
-------------------------	-----

Petrol models (Except 2.0 L engine models)

Engine Coolant	503
----------------------	-----

Diesel models and Petrol models (2.0 L engine models)

Engine Coolant	506
----------------------	-----

Transmission Fluid	508
--------------------------	-----

Brake/Clutch Fluid	510
--------------------------	-----

Refilling Window Washer Fluid	511
-------------------------------------	-----

Fuel Filter	511
-------------------	-----

Diesel Particulate Filter (DPF)

Regeneration*	512
----------------------------	-----

Replacing Light Bulbs	514
------------------------------------	-----

Checking and Maintaining Wiper Blades ..	530
---	-----

Checking and Maintaining Tyres

Checking Tyres	534
----------------------	-----

Wear Indicators	535
-----------------------	-----

Tyre Service Life	535
-------------------------	-----

Tyre and Wheel Replacement	536
----------------------------------	-----

Tyre Rotation	537
---------------------	-----

Snow Traction Devices	538
-----------------------------	-----

Battery	540
----------------------	-----

Remote Transmitter Care	544
--------------------------------------	-----

Climate Control System Maintenance ..	546
--	-----

Cleaning	549
-----------------------	-----

* Not available on all models

Inspection and Maintenance

For your safety, perform all listed inspections and maintenance to keep your vehicle in good condition. If you become aware of any abnormality (noise, smell, insufficient brake fluid, oil residue on the ground, etc.), have your vehicle inspected by a dealer. (Note, however, that service at a dealer is not mandatory to keep your warranties in effect.) Refer to the maintenance schedule in this owner's manual for detailed maintenance and inspection information.

➤ **Maintenance Schedule*** P. 473

Types of Inspection and Maintenance

■ Daily inspections

Perform inspections before long distance trips, when washing the vehicle, or when refueling.

■ Periodic inspections

- Check the automatic transmission fluid level monthly.
 - **Automatic Transmission Fluid** P. 508
- Check the brake fluid level monthly.
 - **Brake/Clutch Fluid** P. 510
- Check the tyre pressure monthly. Examine the tread for wear and foreign objects.
 - **Checking and Maintaining Tyres** P. 534
- Check the operation of the exterior lights monthly.
 - **Replacing Light Bulbs** P. 514
- Check the condition of the wiper blades at least every six months.
 - **Checking and Maintaining Wiper Blades** P. 530

Safety When Performing Maintenance

Some of the most important safety precautions are given here. However, we cannot warn you of every conceivable hazard that can arise in performing maintenance. Only you can decide whether or not you should perform a given task.

Maintenance Safety

- To reduce the possibility of fire or explosion, keep cigarettes, sparks, and flames away from the battery and all fuel related parts.
- Never leave rags, towels, or other flammable objects under the bonnet.
 - ▶ Heat from the engine and exhaust can ignite them causing a fire.
- To clean parts, use a commercially available degreaser or parts cleaner, not petrol.
- Wear eye protection and protective clothing when working with the battery or compressed air.
- Engine exhaust contains carbon monoxide, which is poisonous and can kill you.
 - ▶ Operate the engine only when there is sufficient ventilation.

Vehicle Safety

- The vehicle must be in a stationary condition.
 - ▶ Make sure your vehicle is parked on level ground, the parking brake is set, and the engine is off.
- Be aware that hot parts can burn you.
 - ▶ Make sure to let the engine and exhaust system cool thoroughly before touching vehicle parts.
- Be aware that moving parts can injure you.
 - ▶ Do not start the engine unless instructed, and keep your hands and limbs away from moving parts.

Models with Auto Idle Stop

- ▶ Do not open the bonnet while the Auto Idle Stop function is activated.

⚠ Safety When Performing Maintenance

⚠ WARNING

Improperly maintaining this vehicle or failing to correct a problem before driving can cause a crash in which you can be seriously hurt or killed.

Always follow the inspection and maintenance recommendations and schedules in this owner's manual/Service Book.

⚠ WARNING

Failure to properly follow maintenance instructions and precautions can cause you to be seriously hurt or killed.

Always follow the procedures and precautions in this owner's manual.

Parts and Fluids Used in Maintenance Service

The use of Honda genuine parts and fluids is recommended when maintaining and servicing your vehicle. Honda genuine parts are manufactured according to the same high quality standards used in Honda vehicles.

About Your Maintenance Service

If the service reminder system is available in your vehicle, you are informed by the i-multi-information display when your vehicle's maintenance services are due. Refer to the service book that came with your vehicle for an explanation of the service item codes that appear on the display.

➤ **Service Reminder System*** P. 463

If your vehicle is without the service book, follow the maintenance schedule in this owner's manual.

➤ **Maintenance Schedule*** P. 473

➤ **Oil Monitor System*** P. 468

▶▶ Parts and Fluids Used in Maintenance Service

Diesel models

NOTICE

Do not press the engine cover forcibly. This may damage the engine cover and component parts.

▶▶ About Your Maintenance Service

If you are planning to take your vehicle outside the service reminder system applied countries, consult a dealer for how to record your service reminder information and schedule your maintenance service under the conditions of that country.

Provides information of which service items are to be performed. Service items are represented by a code and icon. The system tells you when to take your vehicle to a dealer by distance or days remaining.

When the next maintenance service timing is near, coming or passed, a warning icon will also appear on the i-multi-information display every time you turn the ignition switch to ON ^{*1}.

*1: Models with the keyless access system have an **ENGINE START/STOP** button instead of an ignition switch.

* Not available on all models



Service Reminder System*

You can choose to have a corresponding warning message displayed with the warning icon on the i-multi-information display.

The maintenance schedule may not display correct information if you disconnect or remove the battery for an extended period. If this occurs, see a dealer.

Continued

■ Displaying the Service Reminder Information

1. Turn the ignition switch to ON *1.
2. Press the **MENU** button to go to the **Vehicle menu** screen.
3. Select **Vehicle information** with the  button, then press the **SOURCE** button.
4. Press the **SOURCE** button again to go to the **Maintenance info** screen. The maintenance item(s) appears on the i-multi-information display.

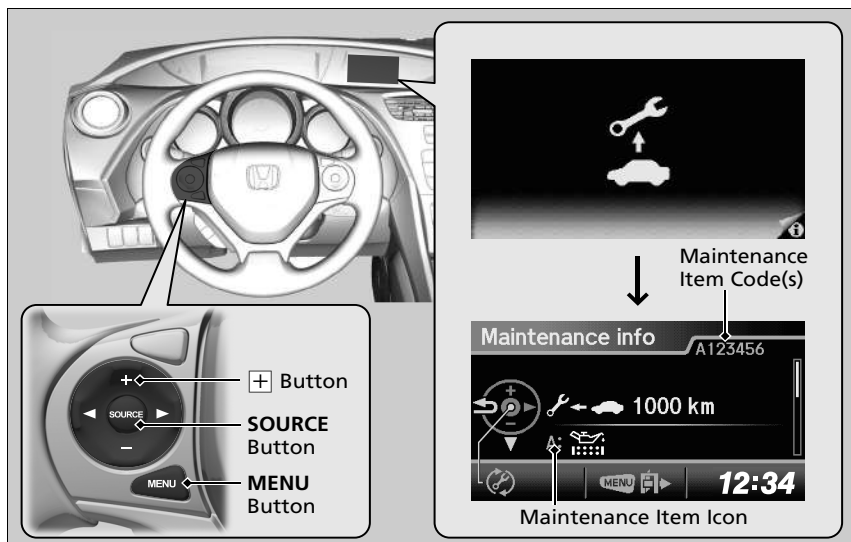

The system message indicator (ⓘ) comes on along with the service reminder information.

*1: Models with the keyless access system have an **ENGINE START/STOP** button instead of an ignition switch.





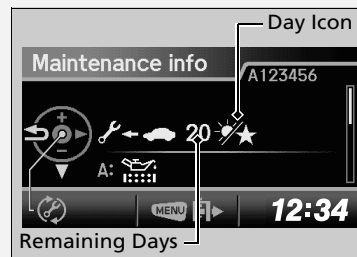

▣ Displaying the Service Reminder Information

Based on engine operating conditions and engine oil conditions, the system calculates the remaining distance or days before the next service is to be performed.

If the system calculates that the indicated time for the next maintenance service comes earlier than the indicated distance, the service reminder information display changes to show the remaining days.



Warning Icons and Service Reminder Information on the i-Multi-Information Display

Warning Icon (Amber)	Service Reminder Information	Explanation	Information
<p>SERVICE DUE SOON</p> 		<p>One or more of the service items are required in less than 30 days. The remaining distance is estimated based on your driving conditions.</p>	<p>The remaining distance will be counted down per 10 kilometres/miles.</p> <p>The remaining days will be counted down per day.</p>
<p>SERVICE DUE NOW</p> 		<p>One or more of the service items are required in less than 10 days. The remaining distance is estimated based on your driving conditions.</p>	<p>Have the indicated service performed as soon as possible.</p>
<p>SERVICE OVER DUE</p> 		<p>The indicated maintenance service is still not done after the remaining distance or time reaches 0.</p>	<p>Your vehicle has passed the service required point. Immediately have the service performed and make sure to reset the service reminder system.</p>

■ Service Reminder Items

Service items displayed on the i-multi-information display are in code and icon. For an explanation of the service reminder codes and icons, refer to the service book that came with your vehicle.

■ Availability of the Service Reminder System

Even if the service reminder information appears on the i-multi-information display while pressing the  (display/information) button, this system is not available in some countries. Refer to the service book that came with your vehicle, or ask a dealer if you can use the service reminder system.

▶▶ Availability of the Service Reminder System

If you are planning to take your vehicle outside the service reminder system applied countries, consult a dealer for how to record your service reminder information and schedule your maintenance service under the conditions of that country.

Resetting the Display

Reset the service reminder information display if you have performed the maintenance service.

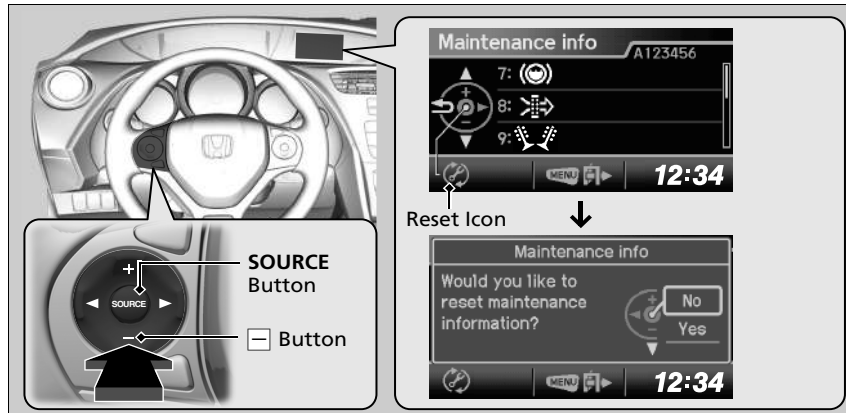

1. Turn the ignition switch to ON *1.
 2. Go to the **Maintenance info** screen.
 - ▶ **Displaying the Service Reminder Information** P. 464
 3. Press the **SOURCE** button.
 - ▶ The service reminder information reset mode is displayed on the i-multi-information display.
 4. Select **Yes** with the button, then press the **SOURCE** button.
 - ▶ The service code will disappear.
- To cancel the service reminder information reset mode, select **No**, then press the **SOURCE** button.

*1: Models with the keyless access system have an **ENGINE START/STOP** button instead of an ignition switch.

Resetting the Display

NOTICE

Failure to reset the service reminder information after a maintenance service results in the system showing incorrect maintenance intervals, which can lead to serious mechanical problems.

The dealer will reset the service reminder information display after completing the required maintenance service. If someone other than a dealer performs maintenance service, reset the service reminder information display yourself.

Oil Monitor System*

Provides information of which service items are to be performed. Service items are represented by a code and icon. The system tells you when to take your vehicle to a dealer by distance remaining.

When the next maintenance service timing is near, coming or passed, a warning icon will also appear on the i-multi-information display every time you set the power mode to ON.

Oil Monitor System*

You can choose to have a corresponding warning message displayed with the warning icon on the i-multi-information display.

■ Displaying the Oil Monitor System Information

1. Set the power mode to ON.
2. Press the **MENU** button to go to the **Vehicle menu** screen.
3. Select **Vehicle information** with the **+** button, then press the **SOURCE** button.
4. Press the **SOURCE** button again to go to the **Maintenance info** screen. The maintenance item(s) appears on the i-multi-information display.

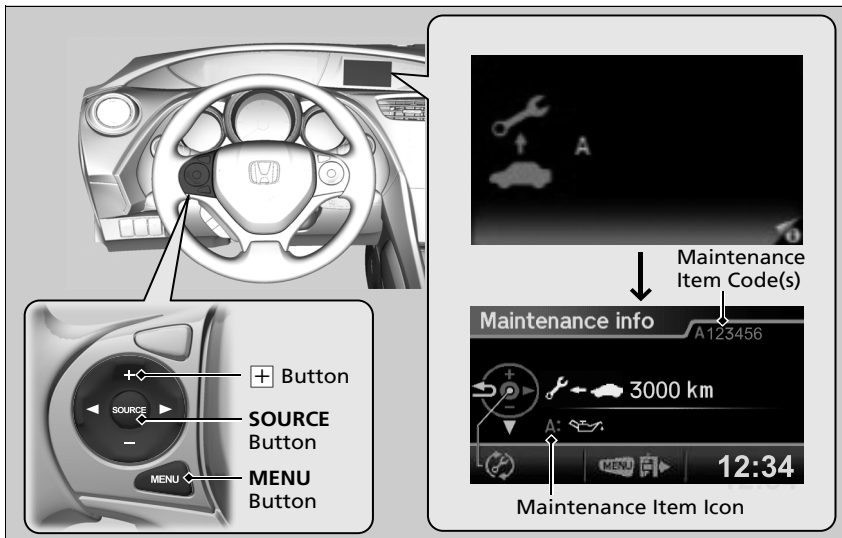





The system message indicator (i) comes on along with the oil monitor system Information.

▣ Displaying the Oil Monitor System Information

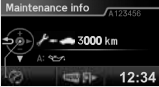
Based on engine operating conditions and engine oil conditions, the system calculates the remaining distance before the next service is to be performed.

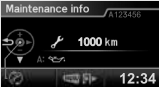
Warning Icons and Oil Monitor System Information on the i-Multi-Information Display

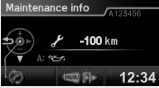
Warning Icon (Amber)	Oil Monitor System Information	Explanation	Information
<p>SERVICE DUE SOON</p> 		<p>When the running distance until the maintenance time is less than 3000 km.</p>	<p>The maintenance time is approaching.</p>
<p>SERVICE DUE NOW</p> 		<p>When the running distance until the maintenance time is less than 1000 km.</p>	<p>Have the indicated maintenance performed as soon as possible.</p>
<p>SERVICE OVER DUE</p> 		<p>The maintenance time has been passed.</p>	<p>The maintenance time has been passed. After performing the maintenance, Reset the oil monitoring system.</p>

Maintenance

■ Service Items

Service items displayed on the i-multi-information display are in code and icon. For an explanation of the service reminder codes and icons, refer to the service book that came with your vehicle.

Resetting the Display

Reset the oil monitor system information display if you have performed the maintenance service.

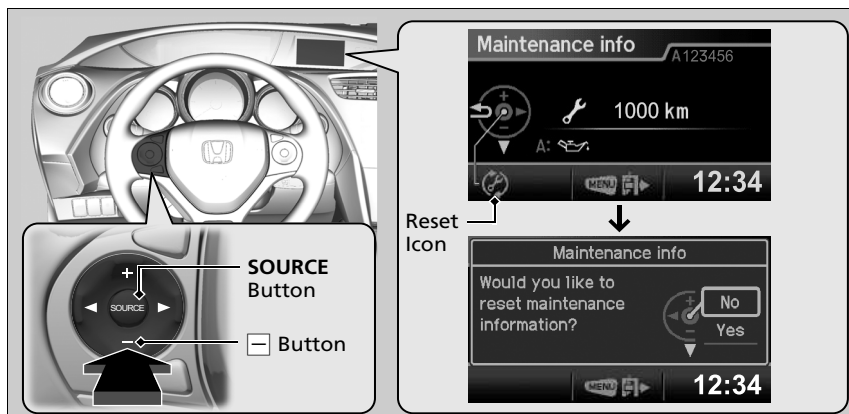

1. Set the power mode to ON.
 2. Go to the **Maintenance info** screen.
 - ▶ **Displaying the Oil Monitor System Information** P. 469
 3. Press the **SOURCE** button.
 - ▶ The oil monitor system information reset mode is displayed on the i-multi-information display.
 4. Select **Yes** with the  button, then press the **SOURCE** button.
 - ▶ The service code will disappear.
- To cancel the oil monitor system information reset mode, select **No**, then press the **SOURCE** button.

Resetting the Display

NOTICE

Failure to reset the oil monitor system information after a maintenance service results in the system showing incorrect maintenance intervals, which can lead to serious mechanical problems.

The dealer will reset the oil monitor system information display after completing the required maintenance service. If someone other than a dealer performs maintenance service, reset the oil monitor system information display yourself.

Maintenance Schedule*

If your vehicle comes with the service book, the maintenance schedule for your vehicle is available in the book. For vehicles without the service book, refer to the following maintenance schedule.

The maintenance schedule outlines the minimum required maintenance that you should perform to ensure the troublefree operation of your vehicle. Due to regional and climatic differences, some additional servicing may be required. Please consult your warranty booklet for a more detailed description.

Maintenance work should be performed by properly trained and equipped technicians. Your authorised dealer meets all of these requirements.

* Not available on all models

Petrol models (Except 2.0 L engine models)

Except European models

Service at the indicated distance or time - whichever comes first.	km X 1,000	20	40	60	80	100	120	140	160	180	200
	miles X 1,000	12.5	25.0	37.5	50.0	62.5	75.0	87.5	100.0	112.5	125.0
	months	12	24	36	48	60	72	84	96	108	120
Replace engine oil	Normal	Every 10,000 km (6,250 miles) or 1 year									
	Severe	Every 5,000 km (3,125 miles) or 6 months									
Replace engine oil filter	Normal	•	•	•	•	•	•	•	•	•	•
	Severe	Every 10,000 km (6,250 miles) or 1 year									
Replace air cleaner element* ¹	Every 30,000 km (18,750 miles)										
Inspect valve clearance	Every 40,000 km (25,000 miles)										
Replace fuel filter* ²				•					•		
Replace spark plugs	Iridium type	Every 100,000 km (62,500 miles)									
Inspect drive belts		•		•		•		•		•	
Inspect idle speed						•					
Replace engine coolant		At 200,000 km (120,000 miles) or 10 years, thereafter every 100,000 km (60,000 miles) or 5 years									

*1: Only severe schedule is required in some countries: refer to the local warranty booklet.

*2: Refer to page 511 for replacement information under driving conditions.

Service at the indicated distance or time - whichever comes first.	km X 1,000		20	40	60	80	100	120	140	160	180	200
	miles X 1,000		12.5	25.0	37.5	50.0	62.5	75.0	87.5	100.0	112.5	125.0
	months		12	24	36	48	60	72	84	96	108	120
Replace transmission fluid	MT	Normal	Every 120,000 km (75,000 miles) or 6 years									
		Severe			•			•			•	
	AT	Normal	At 120,000 km (75,000 miles) or 6 years, thereafter every 80,000 km (50,000 miles) or 4 years									
		Severe			•		•		•		•	
Inspect front and rear brakes	Every 10,000 km (6,250 miles) or 6 months											
Replace brake fluid	Every 3 years											
Check parking brake adjustment	•	•		•		•		•		•		•
Replace dust and pollen filter	•	•	•	•	•	•	•	•	•	•	•	•
Check expiry date for TRK bottle*	•	•	•	•	•	•	•	•	•	•	•	•
Rotate tyres (Check tyre inflation and condition at least once per month)	Every 10,000 km (6,250 miles)											
Visually inspect the following items:												
Tie rod ends, steering gearbox, and boots Suspension components Driveshaft boots	Every 10,000 km (6,250 miles) or 6 months											
Brake hoses and lines (including ABS) All fluid levels and condition of fluid Exhaust system Fuel lines and connections	•	•	•	•	•	•	•	•	•	•	•	•

* Not available on all models

If you drive your vehicle under severe conditions, you must have the following items served to the maintenance schedule indicated as Severe.

Items	Condition
Engine oil and filter	A, B, C, D and E
Transmission fluid	B, D

✎ Maintenance Schedule

- The condition is considered as severe when you drive:
- A. Driving less than 8 km (5 miles), or less than 16 km (10 miles) in freezing temperatures per trip.
 - B. Driving in extremely hot temperature above 35°C.
 - C. With extensive idling or long periods of stop-and-go.
 - D. With a trailer towing, or loaded roof rack, or in mountains.
 - E. Driving on muddy, dusty or de-iced roads.

Petrol models (2.0 L engine models)

Except European models

Service at the indicated distance or time - whichever comes first.	km X 1,000	20	40	60	80	100	120	140	160	180	200
	miles X 1,000	12.5	25.0	37.5	50.0	62.5	75.0	87.5	100.0	112.5	125.0
	months	12	24	36	48	60	72	84	96	108	120
Replace engine oil* ¹	When indicator comes on or every 10,000 km (6,250 miles) or 1 year										
Replace engine oil filter* ¹	When indicator comes on or every 20,000 km (12,500 miles) or 2 years										
Replace air cleaner element	Every 30,000 km (18,750 miles)										
Inspect valve clearance	Every 40,000 km (25,000 miles)										
Replace fuel filter* ²				•					•		
Replace spark plugs Iridium type	Every 100,000 km (62,500 miles)										
Inspect drive belts		•		•		•		•			•
Inspect idle speed						•					
Replace engine coolant	At 200,000 km (120,000 miles) or 10 years, thereafter every 100,000 km (60,000 miles) or 5 years										

*1: Only severe schedule is required in some countries: refer to the local warranty booklet.

*2: Refer to page 511 for replacement information under driving conditions.

Service at the indicated distance or time - whichever comes first.	km X 1,000	20	40	60	80	100	120	140	160	180	200
	miles X 1,000	12.5	25.0	37.5	50.0	62.5	75.0	87.5	100.0	112.5	125.0
	months	12	24	36	48	60	72	84	96	108	120
Replace transmission fluid	Normal	Every 120,000 km (75,000 miles) or 6 years									
	Severe			•			•			•	
Inspect front and rear brakes		Every 10,000 km (6,250 miles) or 6 months									
Replace brake fluid		Every 3 years									
Check parking brake adjustment		•	•		•		•		•		•
Replace dust and pollen filter (If equipped)		•	•	•	•	•	•	•	•	•	•
Check expiry date for TRK bottle (If equipped)		•	•	•	•	•	•	•	•	•	•
Rotate tyres (Check tyre inflation and condition at least once per month)		Every 10,000 km (6,250 miles)									
Visually inspect the following items:											
Tie rod ends, steering gear box, and boots		Every 10,000 km (6,250 miles) or 6 months									
Suspension components											
Driveshaft boots											
Brake hoses and lines (including ABS)		•	•	•	•	•	•	•	•	•	•
All fluid levels and condition of fluid											
Exhaust system											
Fuel lines and connections											

If you drive your vehicle under severe conditions, you must have the following items served to the maintenance schedule indicated as Severe.

Items	Condition
Engine oil and filter	A, B, C, D and E
Transmission fluid	B, D

▣ Maintenance Schedule

The condition is considered as severe when you drive:

- A. Driving less than 8 km (5 miles) per trip or, in freezing temperatures, driving less than 16 km (10 miles) per trip.
- B. Driving in extremely hot, over 35°C (over 95°F) condition.
- C. Extensive idling or long periods of stop-and-go driving.
- D. Towing trailer, driving with a loaded roof rack, or driving in mountainous conditions.
- E. On muddy, dusty or de-iced roads.

Continued

Petrol models (2.0 L engine models)

European models without service reminder system

Normal Condition

Service at the indicated distance or time - whichever comes first.	km X 1,000	20	40	60	80	100	120	140	160	180	200	220	240
	miles X 1,000	12.5	25.0	37.5	50.0	62.5	75.0	87.5	100.0	112.5	125.0	137.5	150
	months	12	24	36	48	60	72	84	96	108	120	132	144
Replace engine oil	When indicator comes on or 1 year												
Replace engine oil filter	When indicator comes on or 2 years												
Replace air cleaner element	Every 60,000 km (37,500 miles)												
Inspect valve clearance	Every 40,000 km (25,000 miles)												
Replace fuel filter						•							•
Replace spark plugs* ¹	Every 120,000 km (75,000 miles)												
Inspect drive belts		•		•		•		•		•		•	
Inspect idle speed						•							•
Replace engine coolant	At 200,000 km (120,000 miles) or 10 years, thereafter every 100,000 km (60,000 miles) or 5 years												
Replace transmission fluid						•							•
Inspect front and rear brakes	•	•	•	•	•	•	•	•	•	•	•	•	•
Replace brake fluid	Every 3 years												
Check parking brake adjustment	•	•		•		•		•		•		•	•
Replace dust and pollen filter* ²		•		•		•		•		•		•	•

*1: More than 50% of driving time above 200 km/h, replace the spark plugs every 60,000 km.

*2: When you drive primarily in urban areas that have high concentrations of soot in the air, under dusty conditions or the air flow from the heating and cooling system/climate control system becomes less than usual. Replace the filter every 20,000 km (12,500 miles) or 1 year.

Service at the indicated distance or time - whichever comes first.	km X 1,000	20	40	60	80	100	120	140	160	180	200	220	240
	miles X 1,000	12.5	25.0	37.5	50.0	62.5	75.0	87.5	100.0	112.5	125.0	137.5	150
	months	12	24	36	48	60	72	84	96	108	120	132	144
Check lights alignment		•	•	•	•	•	•	•	•	•	•	•	•
Test drive (noise, stability, dashboard operation)		•	•	•	•	•	•	•	•	•	•	•	•
Check expiry date for TRK bottle (If equipped)	Every year												
Inspect vehicle corrosion	Every year												
Visually inspect the following items:													
Tie rod ends, steering gear box, and boots													
Suspension components													
Driveshaft boots													
Brake hoses and lines (including ABS)	•	•	•	•	•	•	•	•	•	•	•	•	•
All fluid levels and condition of fluid													
Exhaust system													
Fuel lines and connections													
Tyre condition													

Severe Condition

Service at the indicated distance or time - whichever comes first.	km X 1,000	20	40	60	80	100	120	140	160	180	200	220	240
	miles X 1,000	12.5	25.0	37.5	50.0	62.5	75.0	87.5	100.0	112.5	125.0	137.5	150
	months	12	24	36	48	60	72	84	96	108	120	132	144
Replace engine oil	When indicator comes on or 1 year												
Replace engine oil filter	When indicator comes on or 2 years												
Replace air cleaner element* ¹	Every 30,000 km (18,500 miles)												
Inspect valve clearance	Every 40,000 km (25,000 miles)												
Replace fuel filter							•						•
Replace spark plug* ²	Every 120,000 km (75,000 miles)												
Inspect drive belts		•		•		•		•		•		•	
Inspect idle speed							•						•
Replace engine coolant	At 200,000 km (120,000 miles) or 10 years, thereafter every 100,000 km (60,000 miles) or 5 years												

*1: Use normal schedule except in dusty conditions.

*2: More than 50% of driving time above 200 km/h, replace the spark plugs every 60,000 km.

Service at the indicated distance or time - whichever comes first.	km X 1,000	20	40	60	80	100	120	140	160	180	200	220	240
	miles X 1,000	12.5	25.0	37.5	50.0	62.5	75.0	87.5	100.0	112.5	125.0	137.5	150
	months	12	24	36	48	60	72	84	96	108	120	132	144
Replace transmission fluid	Every 60,000 km (37,500 miles) or 4 years												
Inspect front and rear brakes	Every 10,000 km (6,250 miles) or 6 months												
Replace brake fluid	Every 3 years												
Check parking brake adjustment													
Replace dust and pollen filter* ¹													
Check lights alignment	•	•	•	•	•	•	•	•	•	•	•	•	•
Test drive (noise, stability, dashboard operation)													
Check expiry date for TRK bottle (If equipped)	Every year												
Inspect vehicle corrosion	Every year												
Visually inspect the following items:													
Tie rod ends, steering gear box, and boots	Every 10,000 km (6,250 miles) or 6 months												
Suspension components													
Driveshaft boots													
Brake hoses and lines (including ABS)													
All fluid levels and condition of fluid	•	•	•	•	•	•	•	•	•	•	•	•	•
Exhaust system													
Fuel lines and connections													
Tyre condition													

* 1: When you drive primarily in urban areas that have high concentrations of soot in the air, under dusty conditions or the air flow from the heating and cooling system/climate control system becomes less than usual.

If you drive your vehicle under severe conditions, you must use the severe maintenance schedule.

The condition is considered as severe when you drive:

- Driving less than 8km (5 miles) per trip or, in freezing temperatures, driving less than 16km (10 miles) per trip.
- Driving in extremely hot, over 35°C (over 95°F) condition.
- Extensive idling or long periods of stop-and-go driving.
- Towing trailer, driving with a loaded car-top carrier, or driving in mountainous conditions.
- Driving on muddy, dusty, or de-iced roads.

▣ Maintenance Schedule

NOTE: If you only *OCCASIONALLY* drive under "severe" conditions, you should follow the Normal Conditions Maintenance Schedule on page 480.

Diesel models

Except European models

Service at the indicated distance or time - whichever comes first.	km X 1,000	20	40	60	80	100	120	140	160	180	200
	miles X 1,000	12.5	25.0	37.5	50.0	62.5	75.0	87.5	100.0	112.5	125.0
	months	12	24	36	48	60	72	84	96	108	120
Replace engine oil and oil filter	Normal	Every 10,000 km (6,250 miles) or 1 year									
	Severe	Every 5,000 km (3,125 miles) or 6 months									
Replace air cleaner element		Every 30,000 km (18,750 miles)									
Replace fuel filter		Every 30,000 km (18,750 miles)									
Inspect drive belts			•		•		•		•		•
Replace engine coolant						•			•		

Service at the indicated distance or time - whichever comes first.	km X 1,000		20	40	60	80	100	120	140	160	180	200
	miles X 1,000		12.5	25.0	37.5	50.0	62.5	75.0	87.5	100.0	112.5	125.0
	months		12	24	36	48	60	72	84	96	108	120
Replace transmission fluid	MT	Normal	Every 120,000 km (75,000 miles) or 6 years									
		Severe			•			•			•	
Inspect front and rear brakes	Every 10,000 km (6,250 miles) or 6 months											
Replace brake fluid	Every 3 years											
Check parking brake adjustment			•	•		•		•		•		•
Replace dust and pollen filter			•	•	•	•	•	•	•	•	•	•
Check expiry date for TRK bottle*			•	•	•	•	•	•	•	•	•	•
Rotate tyres (Check tyre inflation and condition at least once per month)	Every 10,000 km (6,250 miles)											
Visually inspect the following items:												
Tie rod ends, steering gearbox, and boots	Every 10,000 km (6,250 miles) or 6 months											
Suspension components												
Driveshaft boots												
Brake hoses and lines (including ABS)			•	•	•	•	•	•	•	•	•	•
All fluid levels and condition of fluid			•	•	•	•	•	•	•	•	•	•
Exhaust system												
Fuel lines and connections												

If you drive your vehicle under severe conditions, you must have the following items served to the maintenance schedule indicated as Severe.

Items	Condition
Engine oil and filter	A, B, C, D and E
Manual transmission fluid	B, D

▣ Maintenance Schedule

The condition is considered as severe when you drive:

- A. Less than 8 km (5 miles), or less than 16 km (10 miles) in freezing temperatures per trip.
- B. In extremely hot temperature above 35°C.
- C. With extensive idling or long periods of stop-and-go.
- D. With a trailer towing, or loaded roof rack, or in mountains.
- E. On muddy, dusty or de-iced roads.

Maintenance Record (On Vehicles without Service Book)

Have your servicing dealer record all required maintenance below. Keep receipts for all work done on your vehicle.

Except 2.0 L Petrol engine models

Except European models

	Km (Mi.) or Month	Date	Sign or Stamp
20,000 km	12,500 Mi. (or 12 Mo.)		
40,000 km	25,000 Mi. (or 24 Mo.)		
60,000 km	37,500 Mi. (or 36 Mo.)		
80,000 km	50,000 Mi. (or 48 Mo.)		
100,000 km	62,500 Mi. (or 60 Mo.)		
120,000 km	75,000 Mi. (or 72 Mo.)		
140,000 km	87,500 Mi. (or 84 Mo.)		
160,000 km	100,000 Mi. (or 96 Mo.)		
180,000 km	112,500 Mi. (or 108 Mo.)		
200,000 km	125,000 Mi. (or 120 Mo.)		

Petrol models (2.0 L engine models)

European models with oil monitor system

Km (Mi.) or Month	Date	Sign or Stamp
20,000 km 12,500 Mi. (or 12 Mo.)		
40,000 km 25,000 Mi. (or 24 Mo.)		
60,000 km 37,500 Mi. (or 36 Mo.)		
80,000 km 50,000 Mi. (or 48 Mo.)		
100,000 km 62,500 Mi. (or 60 Mo.)		
120,000 km 75,000 Mi. (or 72 Mo.)		
140,000 km 87,500 Mi. (or 84 Mo.)		
160,000 km 100,000 Mi. (or 96 Mo.)		
180,000 km 112,500 Mi. (or 108 Mo.)		
200,000 km 125,000 Mi. (or 120 Mo.)		
220,000 km 137,500 Mi. (or 132 Mo.)		
240,000 km 150,000 Mi. (or 144 Mo.)		

Maintenance Items Under the Bonnet

Petrol models (1.4 L engine models)

Engine Oil Fill Cap

Right-hand drive models

Brake Fluid
(Black Cap)

Right-hand drive models

Clutch Fluid
(Light Grey Cap)

Washer Fluid
(Blue Cap)

Engine Coolant
Reserve Tank

Engine Oil Dipstick
(Orange)

Left-hand drive models

Brake Fluid
(Black Cap)

Left-hand drive models

Clutch Fluid
(Light Grey Cap)

Battery

Radiator Cap

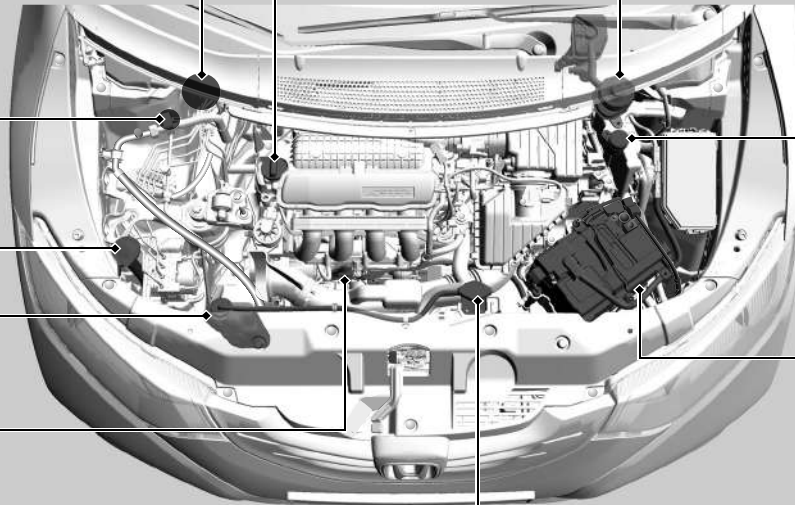

Petrol models (1.8 L engine models)

Engine Oil Fill Cap

Right-hand drive models

Brake Fluid
(Black Cap)

Manual transmission with
right-hand drive models

Clutch Fluid
(Light Grey Cap)

Washer Fluid
(Blue Cap)

Engine Oil Dipstick
(Orange)

Left-hand drive models

Brake Fluid
(Black Cap)

Manual transmission with
left-hand drive models

Clutch Fluid
(Light Grey Cap)

Automatic transmission
models

Automatic
Transmission Fluid
Dipstick
(Yellow Loop)

Battery

Engine Coolant
Reserve Tank

Radiator Cap

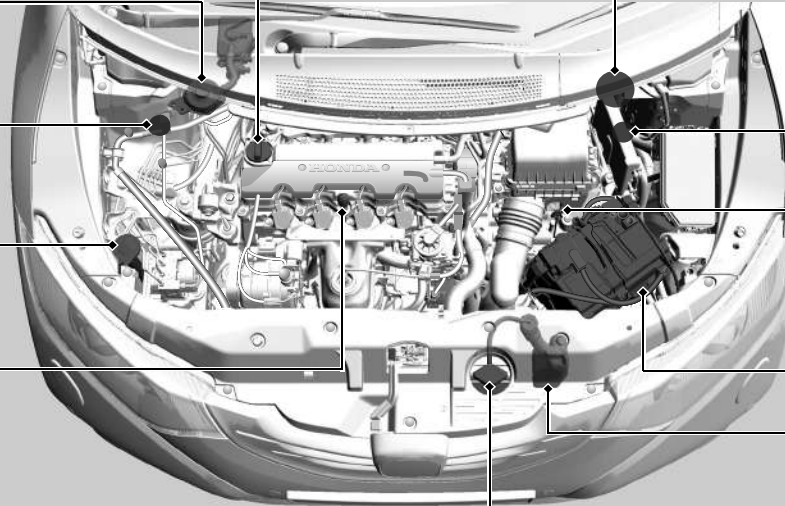

Petrol models (2.0 L engine models)

Engine Oil Fill Cap

Right-hand drive models

Brake Fluid
(Black Cap)

Right-hand drive models

Clutch Fluid
(Light Grey Cap)

Expansion Tank

Washer Fluid
(Blue Cap)

Engine Oil Dipstick
(Black)

Left-hand drive models

Brake Fluid
(Black Cap)

Left-hand drive models

Clutch Fluid
(Light Grey Cap)

Battery

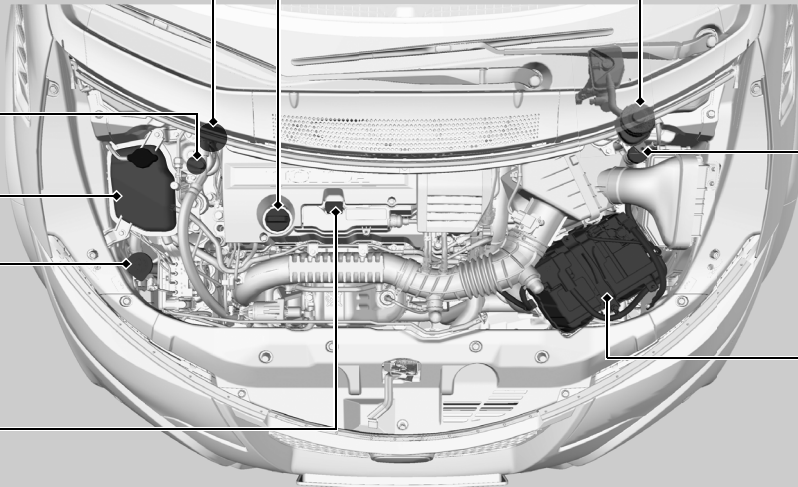

Diesel models

Engine Oil Fill Cap

Right-hand drive models

Brake Fluid
(Black Cap)

Right-hand drive models

Clutch Fluid
(Light Grey Cap)

Expansion Tank

Washer Fluid
(Blue Cap)

Engine Oil Dipstick
(Orange)

Left-hand drive models

Brake Fluid
(Black Cap)

Left-hand drive models

Clutch Fluid
(Light Grey Cap)

Battery

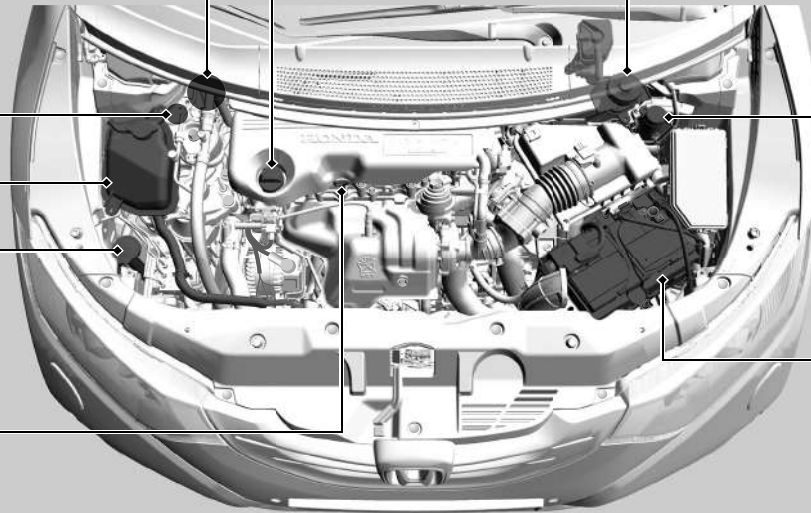

Opening the Bonnet

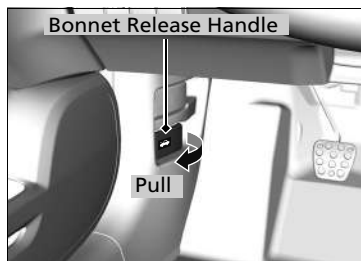

1. Park the vehicle on level ground, and set the parking brake.
2. Pull on the bonnet release handle under the driver's side lower outside corner of the dashboard.
 - The bonnet will pop up slightly.



3. Push up the bonnet latch lever in the centre of the bonnet to release the lock mechanism, and open the bonnet.

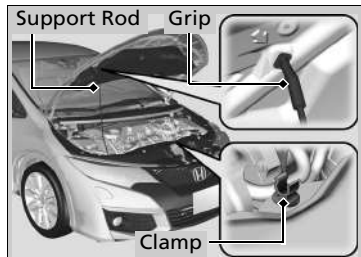

4. Remove the support rod from the clamp using the grip. Mount the support rod in the bonnet.

When closing, remove the support rod, and stow it in the clamp, then gently lower the bonnet. Remove your hand at a height of approximately 30 cm (12 inches) and let the bonnet close.

►► Opening the Bonnet

NOTICE

Do not open the bonnet when the wiper arms are raised. The bonnet will strike the wipers, and may damage either the bonnet or the wipers.

Diesel models

NOTICE

Do not press the engine cover forcibly. This may damage the engine cover and component parts.

When closing the bonnet, check that the bonnet is securely latched.

If the bonnet latch lever moves stiffly, or if you can open the bonnet without lifting the lever, the latch mechanism should be cleaned and lubricated.

Models with Auto Idle Stop

Do not open the bonnet while the Auto Idle Stop function is activated.

Petrol models

Recommended Engine Oil

Oil is a major contributor to your engine's performance and longevity. If you drive the vehicle with insufficient or deteriorated oil, the engine may fail or be damaged.

European models

- **Genuine Honda Motor Oil*1**
- **ACEA A3/B3**
- **ACEA A5/B5**

1.4 L and 1.8 L engine models without service reminder system

- **Genuine Honda Motor Oil*1**
- **ACEA A1/B1**
- **ACEA A3/B3**
- **ACEA A5/B5**

***1: If you use 0W-20, you should use "Honda Engine Oil Type 2.0".**

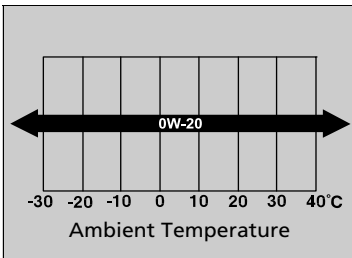

Use a commercial engine oil of suitable viscosity for the ambient temperature as shown.

0W-20 oil is formulated to improve fuel economy.

If 0W-20 is not available, use 5W-30 or 0W-30.

Recommended Engine Oil

Engine Oil Additives

Your vehicle does not require oil additives. In fact, they may adversely affect the engine performance and durability.

ACEA viscosity oil is available for European models only.

Except European models

- **Genuine Honda Motor Oil*¹**
 - **API service SM or higher grade fuel-efficient oil**
- *1: If you use 0W-20, you should use "Honda Engine Oil Type 2.0" or genuine oil which has API service grade mark.**

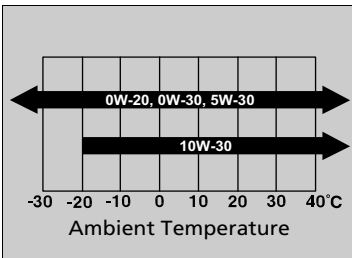

Use a Genuine Honda Motor oil or another commercial engine oil of suitable SAE viscosity for the ambient temperature as shown.

0W-20 oil is formulated to improve fuel economy.

Diesel models

Recommended Engine Oil

Oil is a major contributor to your engine's performance and longevity. If you drive the vehicle with insufficient or deteriorated oil, the engine may fail or be damaged.

- **Honda Diesel Oil #1.0**
- **ACEA C2/C3**

European models

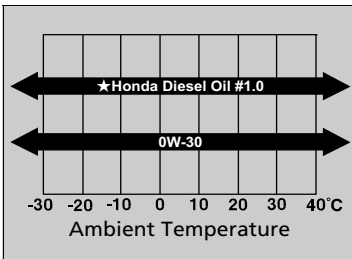

Use a commercial engine oil of suitable viscosity for the ambient temperature as shown.

Honda Diesel Oil #1.0 oil is formulated to improve fuel economy.

If Honda Diesel Oil #1.0 or 0W-30 is not available, use 5W-30.

Except European models

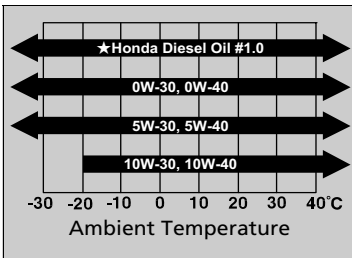

Use a commercial engine oil of suitable viscosity for the ambient temperature as shown.

Honda Diesel Oil #1.0 oil is formulated to improve fuel economy.

Recommended Engine Oil

Engine Oil Additives

Your vehicle does not require oil additives. In fact, they may adversely affect the engine performance and durability.

Oil Check

We recommend that you check the engine oil level every time you refuel.

Park the vehicle on level ground.

Wait approximately three minutes after turning the engine off before you check the oil.

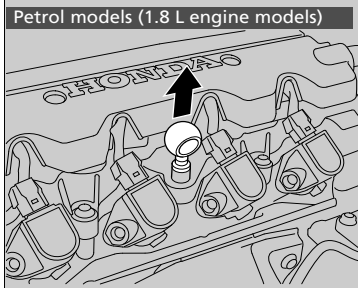
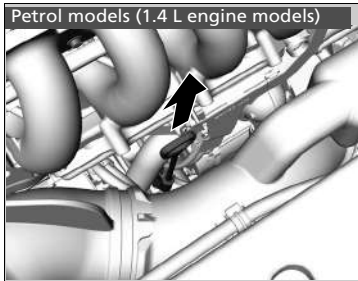

1. Remove the dipstick (orange or black).
2. Wipe the dipstick with a clean cloth or paper towel.
3. Insert the dipstick back all the way into its hole.

Oil Check

If the oil level is near or below the lower mark, slowly add oil being careful not to overfill.

The amount of oil consumed depends on how the vehicle is driven and the climatic and road conditions encountered. The rate of oil consumption can be up to 1 litre per 1,000 km/625 miles. Consumption is likely to be higher when the engine is new.

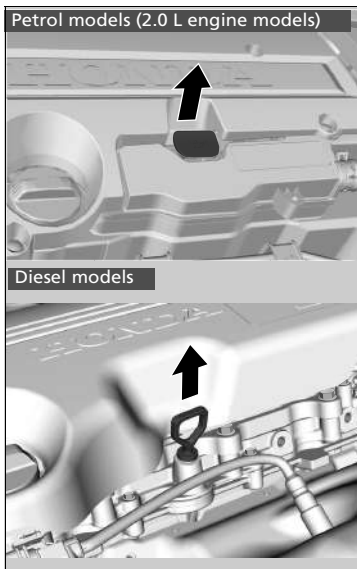

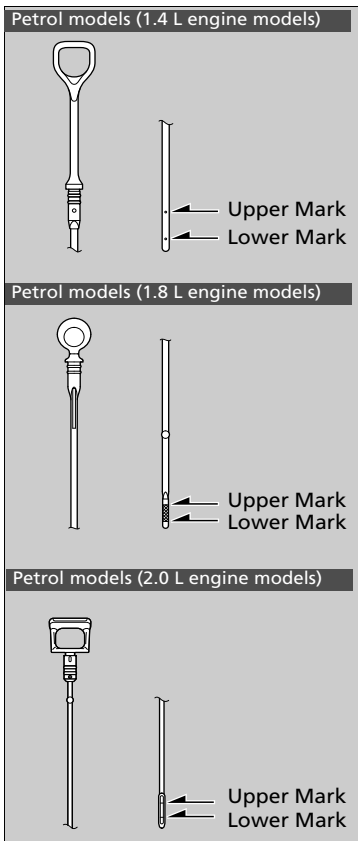

4. Remove the dipstick again, and check the level. It should be between the upper and lower marks. Add oil if necessary.

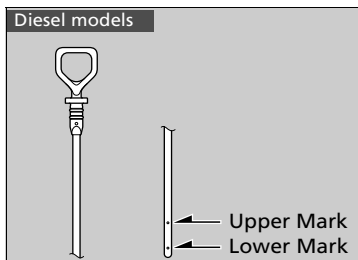

Adding Engine Oil

Petrol models (1.4 L engine models)

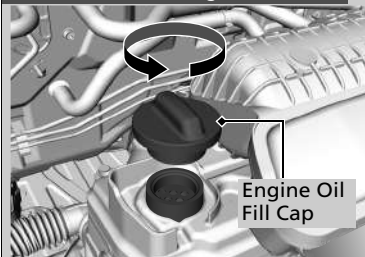

Petrol models (1.8 L engine models)

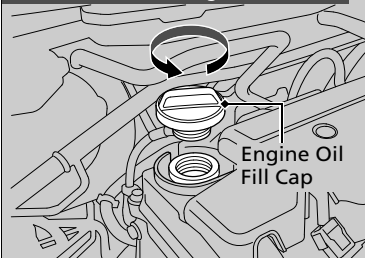

Petrol models (2.0 L engine models)

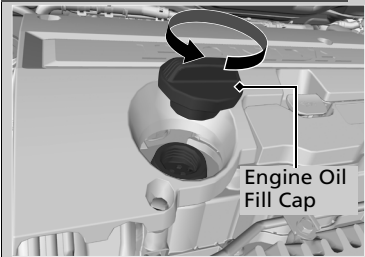

1. Unscrew and remove the engine oil fill cap.
2. Add oil slowly.
3. Reinstall the engine oil fill cap, and tighten it securely.
4. Wait for three minutes and recheck the engine oil dipstick.

► Adding Engine Oil

NOTICE

Do not fill the engine oil above the upper limit mark. Overfilling the engine oil can result in leaks and engine damage.

If any oil spills, wipe it away immediately. Spilled oil may damage the engine compartment components.

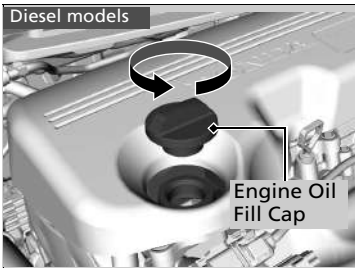

Petrol models (Except 2.0 L engine models)

Engine Coolant

Specified coolant: Honda All Season Antifreeze/Coolant Type 2

This coolant is premixed with 50% antifreeze and 50% water. Do not add any straight antifreeze or water.

We recommend you check the engine coolant level every time you refuel. Check the reserve tank first. If it is completely empty, also check the coolant level in the radiator. Add the engine coolant accordingly.

Engine Coolant

If Honda antifreeze/coolant is not available, you may use another major brand non-silicate coolant as a temporary replacement. Check that it is a high quality coolant recommended for aluminium engines. Continued use of any non-Honda coolant can result in corrosion, causing the cooling system to malfunction or fail. Have the cooling system flushed and refilled with Honda antifreeze/coolant as soon as possible.

Do not add rust inhibitors or other additives to your vehicle's cooling system. They may not be compatible with the coolant or with the engine components.

Continued

Reserve Tank

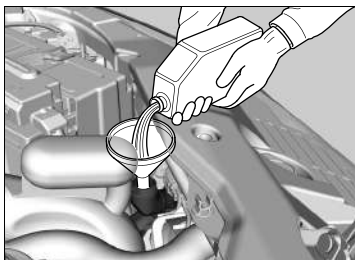
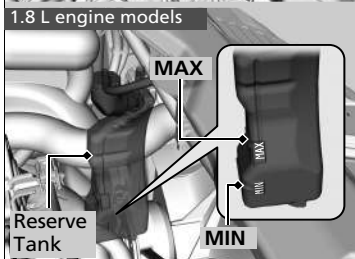
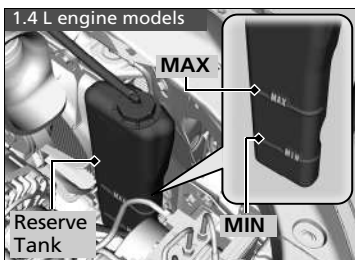

1. Check the amount of coolant in the reserve tank.

2. If the coolant level is below the **MIN** mark, add the specified coolant until it reaches the **MAX** mark.

3. Inspect the cooling system for leaks.

Radiator

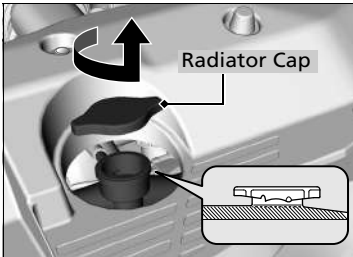

1. **Make sure the engine and radiator are cool.**
2. Turn the radiator cap anticlockwise and relieve any pressure in the coolant system. Do not push the cap down when turning.
3. Push down and turn the radiator cap anticlockwise to remove it.
4. The coolant level should be up to the base of the filler neck. Add coolant if it is low.
5. Put the radiator cap back on, and tighten it fully.
6. Pour coolant into the reserve tank until it reaches the **MAX** mark. Put the cap back on the reserve tank.

Radiator

⚠ WARNING

Removing the radiator cap while the engine is hot can cause the coolant to spray out, seriously scalding you.

Always let the engine and radiator cool down before removing the radiator cap.

NOTICE

Pour the fluid slowly and carefully so you do not spill any. Clean up any spills immediately; they can damage components in the engine compartment.

Diesel models and Petrol models (2.0 L engine models)

Engine Coolant

Specified coolant: Honda All Season Antifreeze/Coolant Type 2

This coolant is premixed with 50% antifreeze and 50% water. Do not add any straight antifreeze or water.

We recommend you check the engine coolant level every time you refuel. Check the expansion tank. Add the engine coolant accordingly.

Checking the Coolant

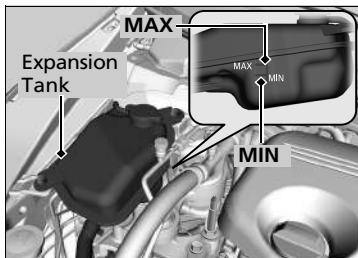

1. Check the amount of coolant in the expansion tank.
2. If the coolant level is below the **MIN** mark, add the specified coolant until it reaches the **MAX** mark.
3. Inspect the cooling system for leaks.

Engine Coolant

If Honda antifreeze/coolant is not available, you may use another major brand non-silicate coolant as a temporary replacement. Check that it is a high quality coolant recommended for aluminium engines. Continued use of any non-Honda coolant can result in corrosion, causing the cooling system to malfunction or fail. Have the cooling system flushed and refilled with Honda antifreeze/coolant as soon as possible.

Do not add rust inhibitors or other additives to your vehicle's cooling system. They may not be compatible with the coolant or with the engine components.

■ Adding the Coolant

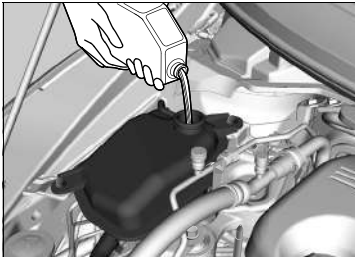
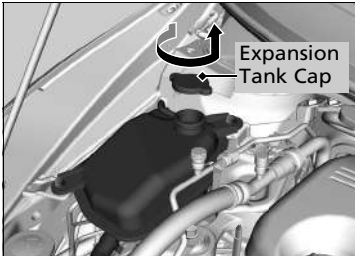

1. **Make sure the engine and radiator are cool.**
2. Turn the expansion tank cap 1/8 turn anticlockwise and relieve any pressure in the coolant system.
3. Push down and turn the expansion tank cap anticlockwise to remove it.
4. Pour coolant into the expansion tank until it reaches the **MAX** mark.
5. Put the expansion tank cap back on, and tighten it fully.

▣ Adding the Coolant

⚠ WARNING

Removing the expansion tank cap while the engine is hot can cause the coolant to spray out, seriously scalding you.

Always let the engine and radiator cool down before removing the expansion tank cap.

NOTICE

Pour the fluid slowly and carefully so you do not spill any. Clean up any spills immediately; they can damage components in the engine compartment.

Transmission Fluid

Automatic Transmission Fluid

Specified fluid: Honda ATF DW-1 (automatic transmission fluid)

Check the fluid level when the engine is at normal operating temperature.

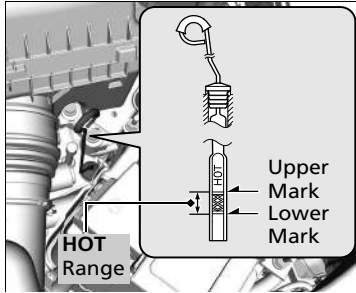

1. Park on level ground, and start the engine.
2. Wait until the radiator fan starts and then turn off the engine.
 - Perform step 3 after waiting for about 60 seconds (less than 90 seconds).
3. Remove the dipstick (yellow loop) from the transmission and wipe it with a clean cloth.
4. Insert the dipstick all the way back into the transmission securely, as shown in the image.
5. Remove the dipstick and check the fluid level.
 - It should be between the upper and lower marks in the **HOT** range.
6. If the level is below the lower mark, add fluid into the dipstick hole to bring it to the level between the upper and lower marks, and have your vehicle checked by a dealer immediately.

Automatic Transmission Fluid

NOTICE

Pour the fluid slowly and carefully so you do not spill any. Clean up any spills immediately; they can damage components in the engine compartment.

NOTICE

Do not mix Honda ATF DW-1 with other transmission fluids.

Using a transmission fluid other than Honda ATF DW-1 may adversely affect the operation and durability of your vehicle's transmission, and damage the transmission.

Any damage caused by using a transmission fluid that is not equivalent to Honda ATF DW-1 is not covered by Honda's new vehicle warranty.

Manual Transmission Fluid

Specified fluid: Honda Manual Transmission Fluid (MTF)

Have a dealer check the fluid level and replace if necessary.

➤ **About Your Maintenance Service** P. 462

Manual Transmission Fluid

If Honda MTF is not available, you may use the API certificated SAE 0W-20 or 5W-20 viscosity motor oil as a temporary measure.

Replace with MTF as soon as possible. Motor oil does not contain the proper additives for the transmission and continued use can cause decreased shifting performance and lead to transmission damage.

Brake/Clutch Fluid

Specified fluid: Brake Fluid with DOT 3 or DOT 4

Use the same fluid for both the brakes and clutch.

■ Checking the Brake Fluid

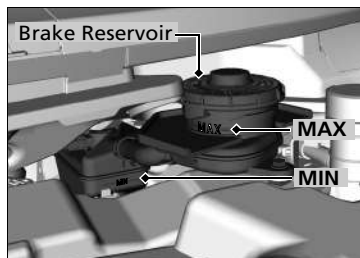

The fluid level should be between the **MIN** and **MAX** marks on the side of the reservoir.

Manual transmission models

■ Checking the Clutch Fluid

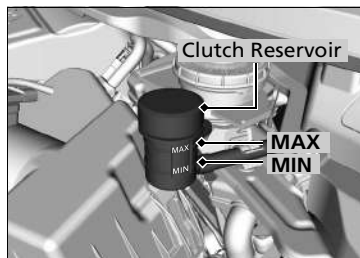

The fluid level should be between the **MIN** and **MAX** marks on the side of the reservoir.

» Brake/Clutch Fluid

NOTICE

Brake fluid marked DOT 5 is not compatible with your vehicle's braking system and can cause extensive damage.

We recommend using a genuine product.

If the brake fluid level is at or below the **MIN** mark, have a dealer inspect the vehicle for leaks or worn brake pads as soon as possible.

» Checking the Clutch Fluid

If the clutch fluid level is at or below the **MIN** mark, have a dealer inspect the vehicle for leaks or an excessively worn clutch plate as soon as possible.

Refilling Window Washer Fluid

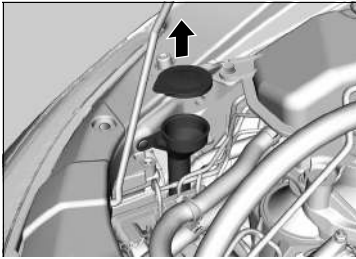

If the level is low, fill the washer reservoir.

Models with washer level sensor

If the washer fluid is low, a message appears on the i-multi-information display. Pour the washer fluid carefully. Do not overflow the reservoir.

Fuel Filter

Replace the fuel filter according to the time and distance recommendations in the maintenance schedule.

Petrol models

Except European models

It is recommended to replace the fuel filter every 40,000 km (25,000 miles), or two years, if you suspect the fuel you are using is contaminated. In a dusty environment, the filter may become clogged sooner.

Have a qualified technician change the fuel filter. Fuel in the system can spray out and create a hazard if all fuel line connections are not handled correctly.

▣ Refilling Window Washer Fluid

NOTICE

Do not use engine antifreeze or a vinegar/water solution in the windscreen washer reservoir. Antifreeze can damage your vehicle's paint. A vinegar/water solution can damage the windscreen washer pump.

Use only commercially available windscreen washer fluid.

Avoid prolonged use of hard water to prevent lime scale build up.

▣ Fuel Filter

The fuel filter should be replaced according to the service reminder indication.

Diesel Particulate Filter (DPF)

Collects PM (particulate matter) from the exhaust gas. The DPF is installed in the catalytic converter.

How the DPF Works

The DPF periodically burns off the collected PM while driving at a high temperature of catalytic converter.

When PM is burned off, you may notice white smoke in the exhaust gas, and the increase in the average fuel consumption. This is temporary, and normal.

⚠ Diesel Particulate Filter (DPF)

The DPF must operate at a high temperature for the chemical reactions to take place. It can set on fire any combustible materials that come near it. Park your vehicle away from high grass, dry leaves, or other flammables.

Regenerating DPF



Regenerate the DPF when this symbol appears.



Take your vehicle to a dealer when this warning symbol appears.

If you see  on the i-multi-information display, you need to regenerate the DPF:

- Drive your vehicle at a speed of 60 km/h (37 mph) or over until the symbol disappears.
- ▶ It takes about 20 minutes to increase the catalytic converter temperature to burn out and remove PM.

Regenerating DPF

NOTICE

If you ignore the symbol and do not regenerate the DPF, the i-multi-information display changes to the DPF warning symbol. If this happens, take your vehicle to a dealer as soon as possible. Continuously ignoring the i-multi-information display warning symbol causes the DPF to be clogged with PM, seriously damaging the DPF and emission control systems.

To minimize the accumulation of PM, always use the recommended diesel fuel.

 **Fuel Information** P. 453

PM is accumulated in the catalytic converter when you drive at a low speed for a long period of time or by frequent short journeys.

Replacing Light Bulbs

Headlight Bulbs

When replacing, use the following bulbs.

High Beam Headlight: 55 W (H7 for halogen bulb type)

Low Beam Headlight: 55 W (H7 for halogen bulb type)*
LED type*

High Beam Headlight

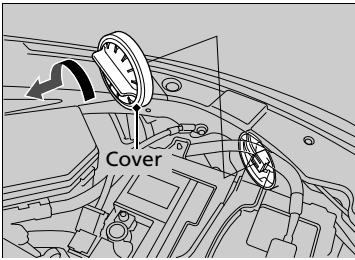

1. Rotate the cover to the left and remove it.

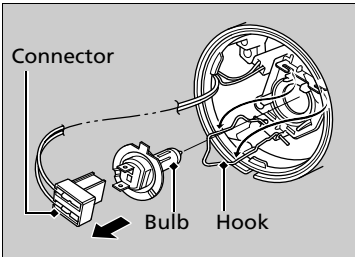

2. Unhook the hook, and pull out the connector.

3. Remove the old bulb and insert the new bulb.

4. Put the connector back into the headlight assembly.

Headlight Bulbs

NOTICE

Halogen bulbs get very hot when lit. Oil, perspiration, or a scratch on the glass can cause the bulb to overheat and shatter.

The headlight aim is set by the factory, and does not need to be adjusted. However, if you regularly carry heavy items in the luggage area or tow a trailer, have the aiming readjusted at a dealer or by a qualified technician.

When replacing a halogen bulb, handle it by its base, and protect the glass from contact with your skin or hard objects. If you touch the glass, clean it with denatured alcohol and a clean cloth.

Low Beam Headlights

Models with halogen headlights

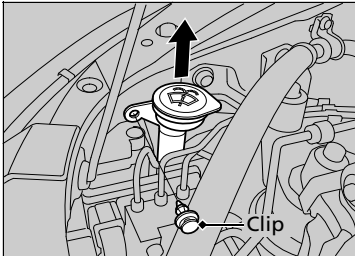

Right side

1. Remove the holding clip using a flat-tip screwdriver, then remove the upper part of the windscreen washer reservoir.

Low Beam Headlights

Holding clip

Insert a flat-tip screwdriver, lift and remove the centre pin to remove the clip.

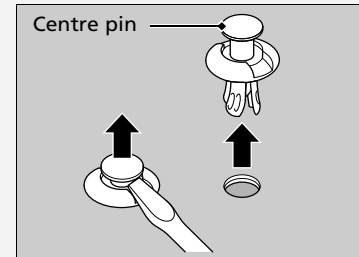

Insert the clip with the central pin raised, and push until it is flat.

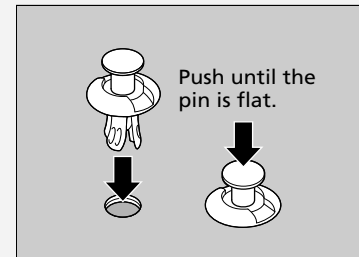

Continued

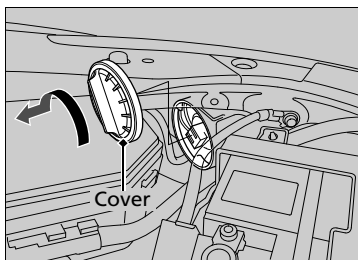

All models

2. Rotate the cover to the left and remove it.

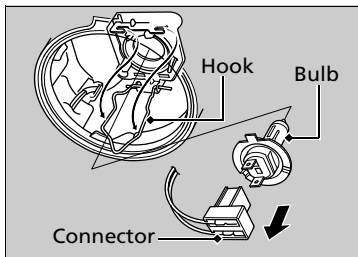

3. Unhook the hook, and pull out the connector.

4. Remove the old bulb and insert the new bulb.

5. Put the connector back into the headlight assembly.

► Low Beam Headlights

Models with LED headlights

Low beam headlights are LED type. Have an authorized Honda dealer inspect and replace the light assembly.

Front Fog Light Bulbs*

When replacing, use the following bulbs.

Front Fog Light: 55 W (H11)

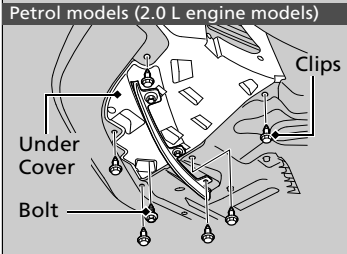

Petrol models (2.0 L engine models)

1. Remove the bolt.

All models

2. Remove the clips using a flat-tip screwdriver, then lower the under cover.

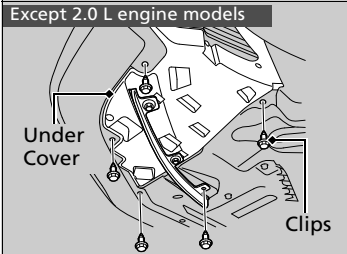

Front Fog Light Bulbs*

NOTICE

Halogen bulbs get very hot when lit. Oil, perspiration, or a scratch on the glass can cause the bulb to overheat and shatter.

When replacing a halogen bulb, handle it by its plastic case, and protect the glass from contact with your skin or hard objects. If you touch the glass, clean it with denatured alcohol and a clean cloth.

* Not available on all models

Continued

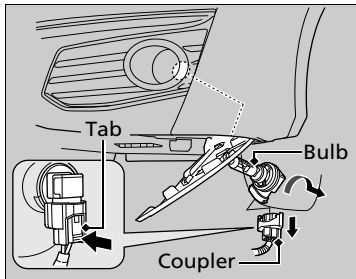

3. Push the tab to remove the coupler.
4. Rotate the old bulb to the left to remove.
5. Insert a new bulb into the fog light assembly and turn it to the right.
6. Insert the coupler into the connector of the bulb.

Position Lights

Position lights are LED type. Have an authorized Honda dealer inspect and replace the light assembly.

Daytime Running Lights

Daytime running lights are LED type. Have an authorized Honda dealer inspect and replace the light assembly.

Front Turn Signal Light Bulbs

When replacing, use the following bulbs.

Front Turn Signal Light: 21 W (Amber)

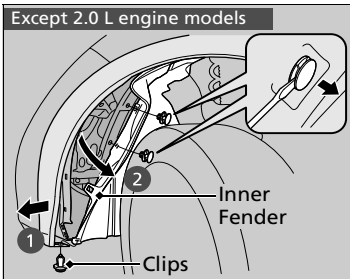
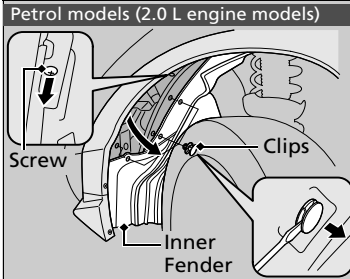

1. Turn the steering wheel all the way to the opposite side from the light being replaced.
Right side: Turn the steering wheel to the left.
Left side: Turn the steering wheel to the right.

Petrol models (2.0 L engine models)

2. Remove the holding clips and screw, then pull the inner fender back.

Except 2.0 L engine models

2. Remove the holding clips, and pull the inner fender back.
 ▣ **Low Beam Headlights** P. 515

Continued

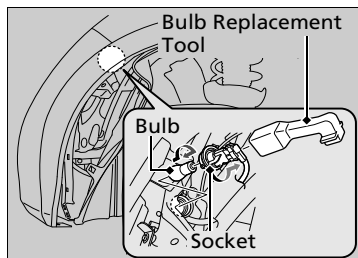

3. Turn the socket to the left and remove it.
 - If you do not remove the socket by the hand, use the bulb replacement tool.
 - ✎ **Types of Tools** P. 556
 - If the bulb replacement tool is not stored in the vehicle, ask a dealer.
4. Push in the old bulb, rotate to the left until it unlocks, and remove it.
5. Insert a new bulb.

Side Turn Signal Lights

Side turn signal lights are LED type. Have an authorized Honda dealer inspect and replace the light assembly.

Rear Turn Signal Light Bulbs

When replacing, use the following bulbs.

Rear Turn Signal Light: 16 W (Amber)

Except 2.0 L engine models

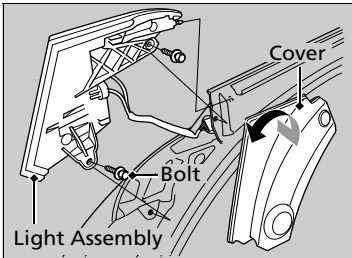

1. Open the tailgate.
2. Remove the cover.
3. Remove the bolts.
4. Pull the light assembly towards the back of the vehicle to remove it.

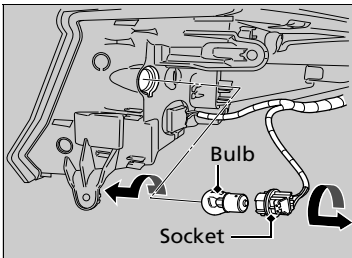

5. Turn the socket to the left and remove it.
6. Push in the old bulb, rotate to the left until it unlocks, and remove it.
7. Insert a new bulb.

Petrol models (2.0 L engine models)

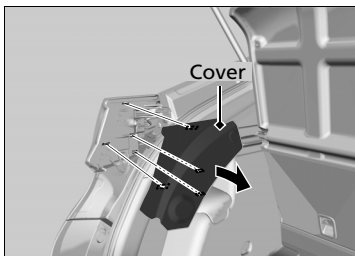

1. Open the tailgate.
2. Remove the cover.

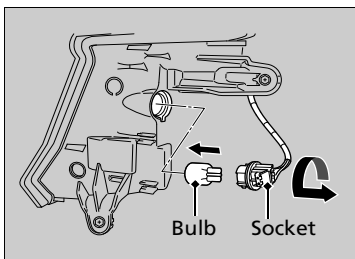

3. Turn the socket to the left and remove it.
4. Push in the old bulb, rotate to the left until it unlocks, and remove it.
5. Insert a new bulb.

Back-Up Light Bulbs

When replacing, use the following bulbs.

Back-Up Light: 16 W

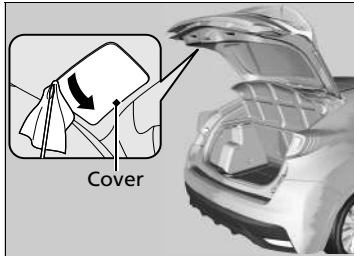

1. Pry on the edge of the cover using a flat-tip screwdriver to remove it.
 - ▶ Wrap the flat-tip screwdriver with a cloth to prevent scratches.

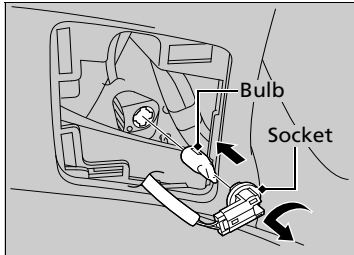

2. Turn the socket to the left and remove it.
3. Remove the old bulb and insert a new bulb.

Brake/Taillights

Brake/taillights are LED type. Have an authorized Honda dealer inspect and replace the light assembly.

Rear Licence Plate Light Bulbs

When replacing, use the following bulbs.

Rear Licence Plate Light: 5 W

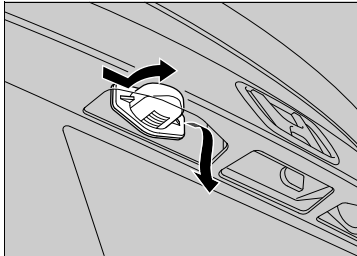

1. Remove the licence plate light assembly by pushing the left edge of the lens towards the right and pulling the assembly out.

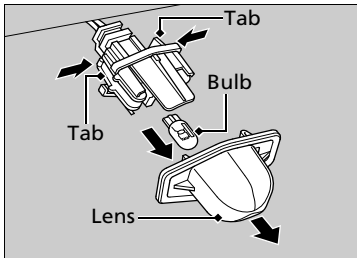

2. Remove the lens by pushing the tabs.
3. Remove the old bulb and insert a new bulb.

High-Mount Brake Light

High-mount brake light is LED type. Have an authorized Honda dealer inspect and replace the light assembly.

Rear Fog Light Bulb

When replacing, use the following bulb.

Rear Fog Light: 21 W

Except 2.0 L engine models

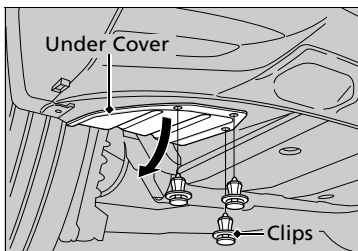

Left side

1. Remove the holding clips using a flat-tip screwdriver, then lower the under cover.

➤ **Low Beam Headlights** P. 515

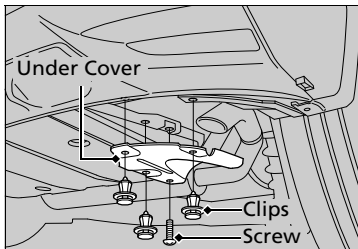

Right side

1. Remove the holding clips and screw, then remove the under cover.

➤ **Low Beam Headlights** P. 515

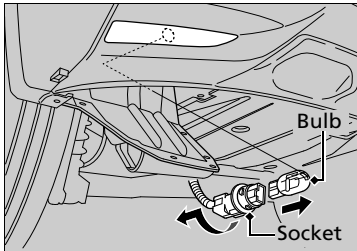

All models

2. Turn the socket to the left and remove it.
3. Remove the old bulb and insert a new bulb.

Petrol models (2.0 L engine models)

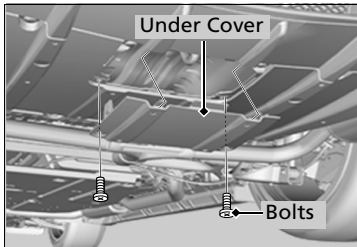

1. Remove the bolts, then remove the under cover.

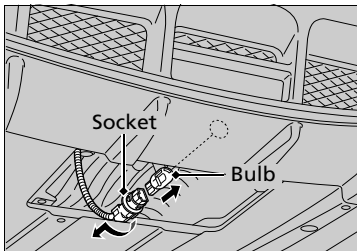

2. Turn the socket to the left and remove it.
3. Remove the old bulb and insert a new bulb.

Other Light Bulbs

■ Ceiling Light Bulb

When replacing, use the following bulb.

Ceiling Light: 8 W

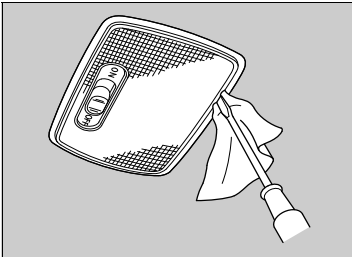

1. Pry on the edge of the cover using a flat-tip screwdriver to remove the cover.
 - Wrap the flat-tip screwdriver with a cloth to prevent scratches.

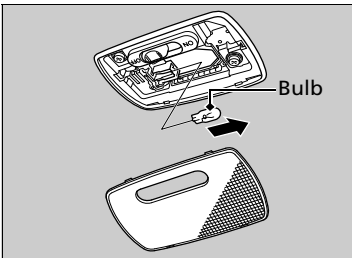

2. Remove the old bulb and insert a new bulb.

* Not available on all models

■ Map Light Bulbs*

When replacing, use the following bulbs.

Map Light: 8 W

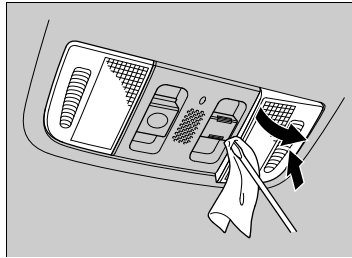

1. Push on the lens of the opposite side you are replacing.
2. Pry on the edge of the cover using a flat-tip screwdriver to remove the cover.
 - Wrap the flat-tip screwdriver with a cloth to prevent scratches.

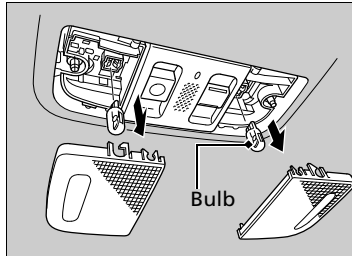

3. Remove the old bulb and insert a new bulb.

■ Map Light Bulbs*

When replacing, use the following bulbs.

Map Light: 8 W

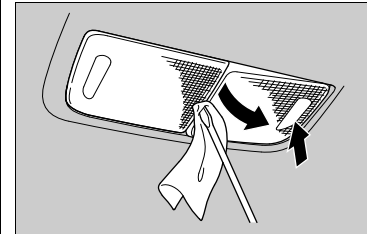

1. Push on the lens of the opposite side you are replacing.
2. Pry on the edge between the lenses using a flat-tip screwdriver to remove the cover.
 - Wrap the flat-tip screwdriver with a cloth to prevent scratches.

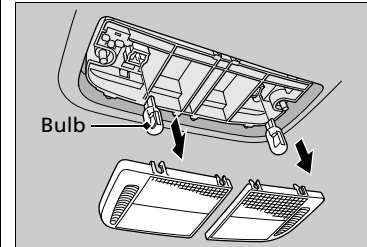

3. Remove the old bulb and insert a new bulb.

■ Vanity Mirror Light Bulbs*

When replacing, use the following bulbs.

Vanity Mirror Light: 2 W

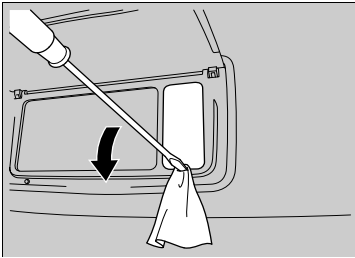

1. Pry on the edge of the cover using a flat-tip screwdriver to remove the cover.
► Wrap the flat-tip screwdriver with a cloth to prevent scratches.

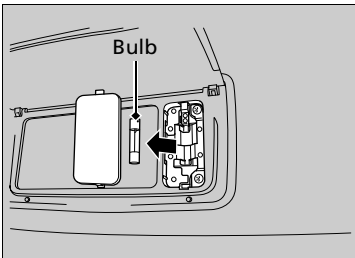

2. Remove the old bulb and insert a new bulb.

■ Luggage Area Light Bulb

When replacing, use the following bulb.

Luggage Area Light: 5 W

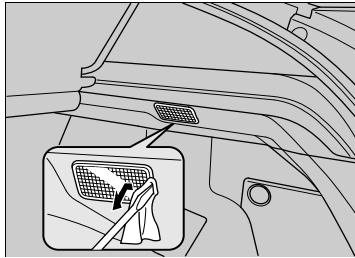

1. Pry on the edge of the cover using a flat-tip screwdriver to remove the cover.
► Wrap the flat-tip screwdriver with a cloth to prevent scratches.

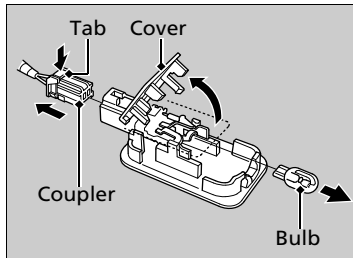

2. Push the tab to remove the coupler.

3. Remove the plastic cover by pivoting it upward.
4. Remove the old bulb and insert a new bulb.
5. Insert the coupler into the connector of the light assembly.

Glove Box Light Bulb*

When replacing, use the following bulb.

Glove Box Light: 3.4 W

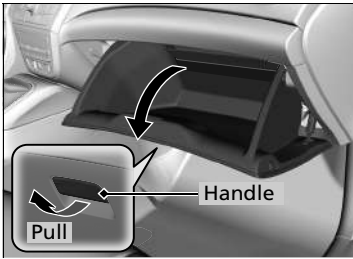

1. Open the glove box.

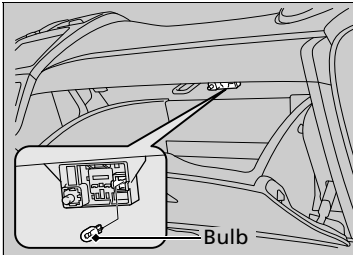

2. Remove the old bulb and insert a new bulb.

* Not available on all models

Checking Wiper Blades

If the wiper blade rubber has deteriorated, it will leave streaks and the hard surfaces of the blade may scratch the window glass.

Changing the Front Wiper Blade Rubber

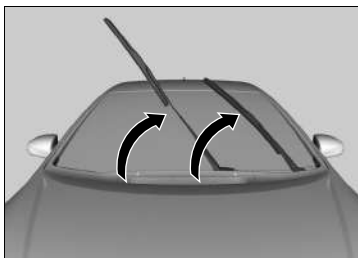

1. Lift the driver side wiper arm first, then the passenger side.

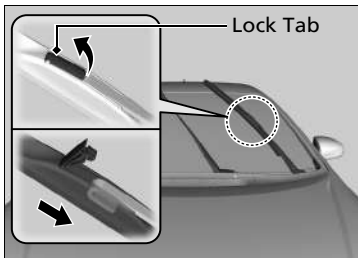

2. Place a cloth on the edge of the lock tab. Push the lock tab up with a flat-tip screw driver.
3. Slide the blade from the wiper arm.

✕ Changing the Front Wiper Blade Rubber

NOTICE

Avoid dropping the wiper arm; it may damage the windshield.

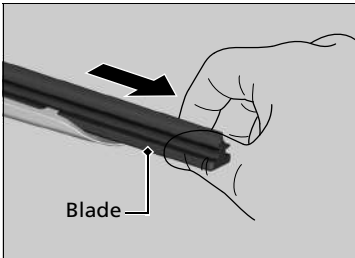

- 4.** Slide the wiper blade out from its holder by pulling the tabbed end out.

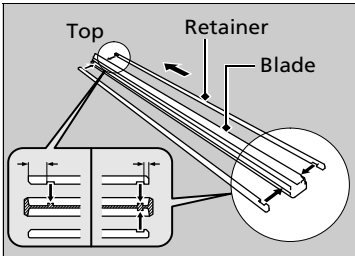

- 5.** Remove the retainers from the rubber blade that has been removed, and mount to a new rubber blade.
 ▶ Correctly align the rubber protrusion and the retainer grooves.

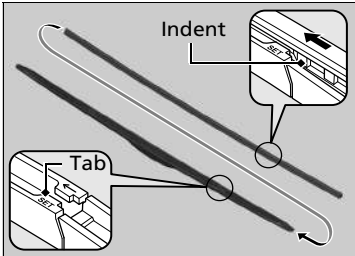

- 6.** Slide the new wiper blade onto the holder from the bottom end.
 ▶ The tab on the holder should fit in the indent of the wiper blade.
- 7.** Slide the wiper blade onto the wiper arm, then push down the lock tab.
- 8.** Lower the passenger side wiper arm first, then the driver side.

Changing the Rear Wiper Blade Rubber*

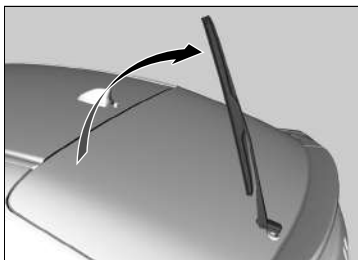

1. Lift the wiper arm.

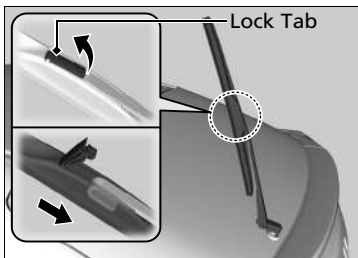

2. Place a cloth on the edge of the lock tab.
Push the lock tab up with a flat-tip screw driver.
3. Slide the blade from the wiper arm.

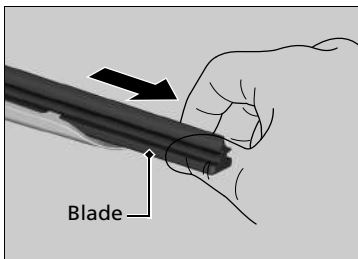

4. Slide the wiper blade out from its holder by pulling the tabbed end out.

► Changing the Rear Wiper Blade Rubber*

NOTICE

Avoid dropping the wiper arm; it may damage the rear window.

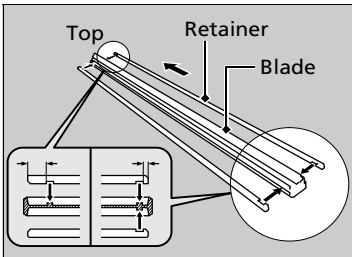

5. Remove the retainers from the rubber blade that has been removed, and mount to a new rubber blade.
 - Correctly align the rubber protrusion and the retainer grooves.

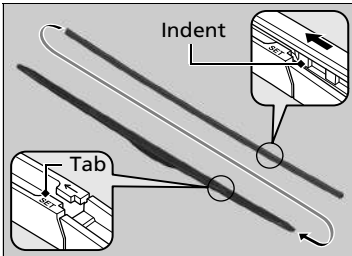

6. Slide the new wiper blade onto the holder from the bottom end.
 - The tab on the holder should fit in the indent of the wiper blade.
7. Slide the wiper blade onto the wiper arm, then push down the lock tab.
8. Lower the wiper arm.

Checking Tyres

To safely operate your vehicle, your tyres must be of the proper type and size, in good condition with adequate tread, and properly inflated.

■ Inflation guidelines

Properly inflated tyres provide the best combination of handling, tread life, and comfort. Refer to the driver's doorjamb label for the specified pressure.

Underinflated tyres wear unevenly, adversely affect handling and fuel economy, and are more likely to fail from overheating.

Overinflated tyres make your vehicle ride harshly, are more prone to road hazards, and wear unevenly.

Every day before you drive, look at each of the tyres. If one looks lower than the others, check the pressure with a tyre gauge.

At least once a month or before long trips, use a gauge to measure the pressure in all tyres, including the spare*. Even tyres in good condition can lose 10 to 20 kPa (0.1 to 0.2 bar, 1 to 2 psi) per month.

■ Inspection guidelines

Every time you check inflation, also examine the tyres and valve stems.

Look for:

- Bumps or bulges on the side or in the tread. Replace the tyre if you find any cuts, splits, or cracks in the side of the tyre. Replace it if you see fabric or cord.
- Remove any foreign objects and inspect for air leaks.
- Uneven tread wear. Have a dealer check the wheel alignment.
- Excessive tread wear.

📖 **Wear Indicators** P. 535

- Cracks or other damage around valve stem.

* Not available on all models

📖 Checking Tyres

⚠️ WARNING

Using tyres that are excessively worn or improperly inflated can cause a crash in which you can be seriously hurt or killed.

Follow all instructions in this owner's manual regarding tyre inflation and maintenance.

Measure the air pressure when tyres are cold. Tyres are considered as cold when the vehicle has been parked for at least three hours, or driven less than 1.6 km (1 mile). If necessary, add or release air until the specified pressure is reached.

If checked when hot, tyre pressure can be as much as 30–40 kPa (0.3–0.4 bar, 4–6 psi) higher than if checked when cold.

Have a dealer check the tyres if you feel a consistent vibration while driving. New tyres and any that have been removed and reinstalled should be properly balanced.

Wear Indicators

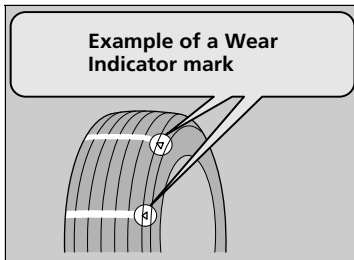

The groove where the wear indicator is located is 1.6 mm (1/16 inch) shallower than elsewhere on the tyre. If the tread has worn so that the indicator is exposed, replace the tyre.

Worn out tyres have poor traction on wet roads.

Tyre Service Life

The life of your tyres is dependent on many factors, including driving habits, road conditions, vehicle loading, inflation pressure, maintenance history, speed, and environmental conditions (even when the tyres are not in use).

In addition to regular inspections and inflation pressure maintenance, it is recommended that you have annual inspections performed once the tyres reach five years old. All tyres, including the spare*, should be removed from service after 10 years from the date of manufacture, regardless of their condition or state of wear.

* Not available on all models

Tyre and Wheel Replacement

Replace your tyres with radials of the same size, load range, speed rating, and maximum cold tyre pressure rating (as shown on the tyre's sidewall). Using tyres of a different size or construction can cause the ABS (anti-lock brake system) and VSA (vehicle stability assist) system to work incorrectly.

It is best to replace all four tyres at the same time. If that isn't possible, replace the front or rear tyres in pairs.

Make sure that the wheel's specifications match those of the original wheels.

▣ Tyre and Wheel Replacement

WARNING

Installing improper tyres on your vehicle can affect handling and stability. This can cause a crash in which you can be seriously hurt or killed.

Always use the size and type of tyres recommended in the tyre information label on your vehicle.

Tyre Rotation

Rotating tyres according to the maintenance schedule helps to distribute wear more evenly and increase tyre life.

Your Vehicle's Tyre Rotation Pattern

Rotate the tyres as shown here.

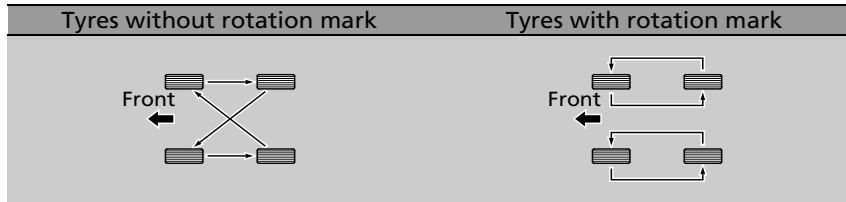

▣ Tyre Rotation

Tyres with directional tread patterns should only be rotated front to back (not from one side to the other). Directional tyres should be mounted with the rotation mark facing forward, as shown below.

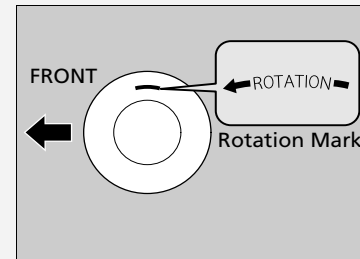

When the tyres are rotated, make sure the air pressures are checked.

Snow Traction Devices

If driving on snowy or frozen roads, mount winter tyres, or tyre chains; reduce speed; and maintain sufficient distance between vehicles when driving.

Be particularly careful when operating the steering wheel or brakes to prevent skidding.

Use tyre chains, winter tyres, or all season tyres when necessary or according to the law.

When mounting, refer to the following points.

For winter tyres:

- Select the size and load ranges that are the same as the original tyres.
- Mount the tyres to all four wheels.

For tyre chains:

- Consult a dealer before purchasing any type of chains for your vehicle.
- Install them on the front tyres only.
- Because your vehicle has limited tyre clearance, we strongly recommend using the chains listed below:

Original Tyre Size*1	Chain Type
235/35ZR19 91Y*3	(Not Available)
225/40R18 92Y	RUD-matic classic 48489
225/45R17 91 W*2	(Not Available)
205/55R16 91 V	RUD-matic classic 48484
195/65R15 91 T	RUD-matic classic 48482

*1: Original tyre size is mentioned on the tyre information label on the driver's doorjamb.

*2: You cannot mount chains on this tyre. If you have to use tyre chains, replace the tyres with the original 205/55R16 size tyres.

*3: You cannot mount chains on this tyre. If you have to use tyre chains, replace the tyres with the original 225/40R18 size tyres.

☒ Snow Traction Devices

⚠ WARNING

Using the wrong chains, or not properly installing chains, can damage the brake lines and cause a crash in which you can be seriously injured or killed.

Follow all instructions in this owner's manual regarding the selection and use of tyre chains.

NOTICE

Traction devices that are the wrong size or improperly installed can damage your vehicle's brake lines, suspension, body, and wheels. Stop driving if they are hitting any part of the vehicle.

According to the EEC Directive for tyres, when winter tyres are used, it is necessary to affix a sticker with the allowable max. speed of the winter tyres clearly in the field of view of the driver, if the designed max. speed of vehicle is higher than the allowed max. speed of winter tyre. A sticker is obtainable from your tyre dealer. If you have any question, consult a dealer.

When tyre chains are mounted, follow the chain manufacturer's instructions regarding vehicle operational limits.

Use tyre chains only in an emergency or when they are legally required for driving through a certain area.

Use greater caution when driving with tyre chains on snow or ice. They may have less-predictable handling than good winter tyres without chains.

- Follow the chain manufacturer's instruction when installing. Mount them as tightly as you can.
- Check that the chains do not touch the brake lines or suspension.
- Drive slowly.

❏ Snow Traction Devices

Petrol models (2.0 L engine models)

We recommend that you do not use the original high performance tyre at temperatures below -20°C. You may experience reduced performance and tyres can become brittle and suffer surface cracking.

Checking the Battery

Check the battery terminals for corrosion monthly.

If your vehicle's battery is disconnected or goes dead:

- The audio system is disabled.
 - **Reactivating the audio system** P. 225
- The clock resets.
 - **Clock** P. 148
- The navigation system is disabled. A PIN code will be required.
 - **Refer to the navigation system manual***

ⓘ Battery

WARNING

The battery gives off explosive hydrogen gas during normal operation.

A spark or open flame can cause the battery to explode with enough force to kill or seriously hurt you.

Keep all sparks, open flames, and smoking materials away from the battery.

Wear protective clothing and a face shield, or have a skilled technician do any battery maintenance.

WARNING

The battery contains sulfuric acid (electrolyte) which is highly corrosive and poisonous.

Getting electrolyte in your eyes or your skin can cause serious burns. Wear protective clothing and eye protection when working on or near the battery.

Swallowing electrolyte can cause fatal poisoning if immediate action is not taken.

KEEP OUT OF THE REACH OF CHILDREN

Charging the Battery

Disconnect both battery cables to prevent damaging your vehicle's electrical system. Always disconnect the negative ⊖ cable first, and reconnect it last.

Replacing the Battery

When you remove and replace the battery, always follow the maintenance safety and the warnings for when checking the battery to prevent potential hazards.

➤ **Maintenance Safety** P. 461

➤ **Checking the Battery** P. 540

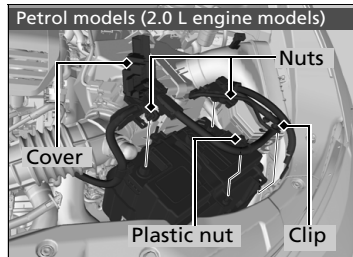

1. Turn the ignition switch to LOCK $\boxed{0}^{*1}$.
Open the bonnet.

Petrol models (2.0 L engine models)

2. Loosen the plastic nut and remove the clip on the negative battery cable.

All models

3. Loosen the nut on the negative battery cable, then disconnect the cable from the ⊖ terminal.
4. Open the positive battery terminal cover. Loosen the nut on the positive battery cable, then disconnect the cable from the ⊕ terminal.

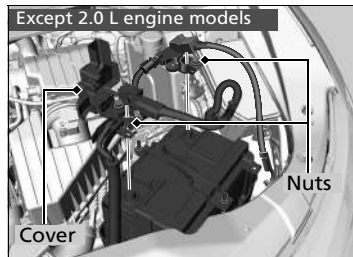

*1: Models with the keyless access system have an **ENGINE START/STOP** button instead of an ignition switch.

Battery

Emergency Procedures

Eyes: Flush with water from a cup or other container for at least 15 minutes. (Water under pressure can damage the eye.) Call a physician immediately.

Skin: Remove contaminated clothing. Flush the skin with large quantities of water. Call a physician immediately.

Swallowing: Drink water or milk. Call a physician immediately.

When you find corrosion, clean the battery terminals by applying a baking powder and water solution. Clean the terminals with a damp towel. Cloth/towel dry the battery. Coat the terminals with grease to help to prevent future corrosion.

Replacing the Battery

NOTICE

An improperly disposed of battery can be harmful to the environment and human health. Always confirm local regulations for battery disposal.

This symbol on the battery means that this product must not be treated as household waste.



Continued

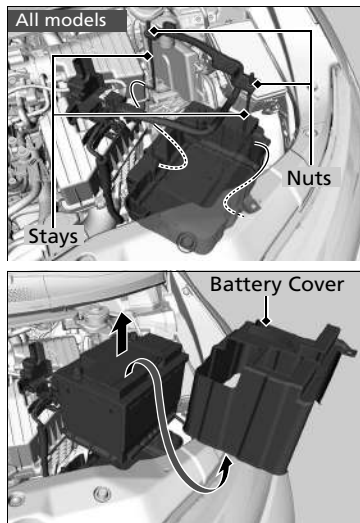

5. Loosen the nut on each side of the battery bracket with a wrench.
6. Pull the bottom end of each battery stay out of the hole on the battery base, and remove the combination of the battery bracket and the stays
7. Remove the battery cover*.
8. Take out the battery carefully.

►► Replacing the Battery

Always disconnect the \ominus cable first, and reconnect it last.

To install a new battery, reverse this procedure.

Models with Auto Idle Stop

The battery installed in this vehicle is specifically designed for a models with Auto Idle Stop. Using a battery other than this specified type may shorten the battery life, and prevent Auto Idle Stop from activating. if you need to replace the battery, make sure to select the specified type. Ask a dealer for more details.

► **Specifications** P. 608, 611, 614, 616

Battery Label



▶▶ Battery Label

DANGER

- Keep flames and sparks away from the battery. The battery produces explosive gas that can cause an explosion.
- Wear eye protection and rubber gloves when handling the battery to avoid risk of burns or loss of eyesight if exposed to battery electrolyte.
- Do not allow children to handle the battery, under any circumstance. Ensure that anyone handling the battery has a proper understanding of the hazards and correct handling procedures involved.
- Handle battery electrolyte with extreme care, as it contains dilute sulfuric acid. Exposure to eyes or skin can cause burns or loss of eyesight.
- Read this manual carefully, and understand it before handling the battery. Failure to do so can cause personal injury and damage to the vehicle.
- Do not use the battery if the level of electrolyte is at or below the recommended level. Using the battery with low electrolyte can cause it to explode, causing serious injury.

Replacing the Button Battery

If the indicator does not come on when the button is pressed, replace the battery.

Retractable Key *

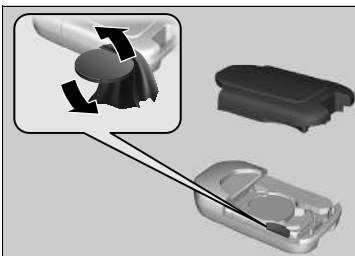

Battery type: CR2032

1. Remove the upper half of the cover by carefully prying on the edge with a coin.
 - ▶ Wrap a coin with a cloth to prevent scratching the retractable key.

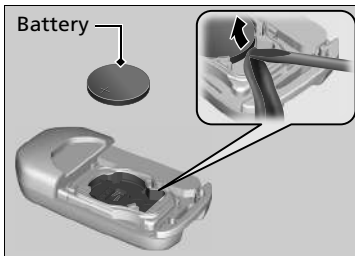

2. Remove the button battery with the small flat-tip screwdriver.
3. Make sure to replace the battery with the correct polarity.

Replacing the Button Battery

NOTICE

An improperly disposed of battery can damage the environment. Always confirm local regulations for battery disposal.

This symbol on the battery means that this product must not be treated as household waste.



Replacement batteries are commercially available or at a dealer.

■ Keyless Remote *



Battery type: CR2032

1. Remove the built-in key.
2. Remove the upper half of the cover by carefully prying on the edge with a coin.
 - ▶ Remove carefully to avoid losing the buttons.
 - ▶ Wrap a coin with a cloth to prevent scratching the keyless remote.
3. Make sure to replace the battery with the correct polarity.

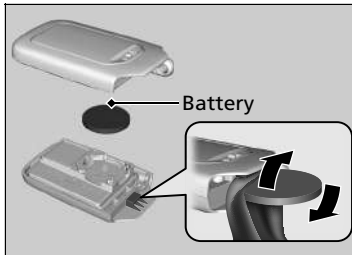

* Not available on all models

Air Conditioning

For proper and safe operation of the climate control system, the refrigerant system should only be served by a qualified technician.

Never repair or replace the air conditioning evaporator (cooling coil) with one removed from a used or salvaged vehicle.

Climate Control System Maintenance

NOTICE

Vented refrigerant is harmful to the environment. To avoid refrigerant from venting, never replace the evaporator with one removed from a used or salvaged vehicle.

Refrigerant in your vehicle's air conditioning system is flammable and can be ignited during servicing if proper procedures are not followed.

Air Conditioner label is found under the bonnet:



 : Caution

 : Flammable Refrigerant

 : Requires Registered Technician to Service

 : Air Conditioning System

Dust and Pollen Filter

When to Replace the Dust and Pollen Filter

Replace the dust and pollen filter according to your vehicle's recommended maintenance schedule. It is recommended to replace the filter even sooner if the vehicle has been driven in a dusty environment.

📖 **Maintenance Schedule*** P. 473

How to Replace the Dust and Pollen Filter

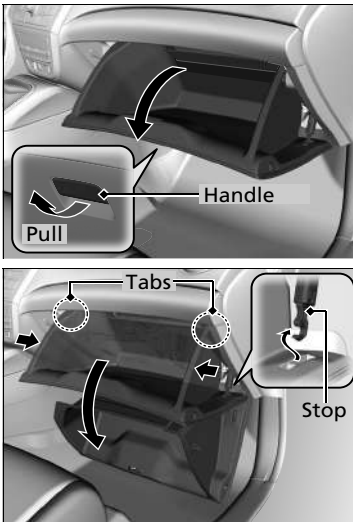

1. Open the glove box.

2. Push the stop on the passenger's side of the glove box to detach it from the glove box.

3. Disengage the two tabs by pushing on each side panel.

4. Pivot the glove box out of the way.

📖 Dust and Pollen Filter

Using an air freshener may reduce the deodorizing effect of the dust and pollen filter, and may reduce its life.

If the airflow from the climate control system deteriorates noticeably, and the windows fog up easily, the filter may need to be replaced.

The dust and pollen filter collects pollen, dust, and other debris in the air.

* Not available on all models

Continued

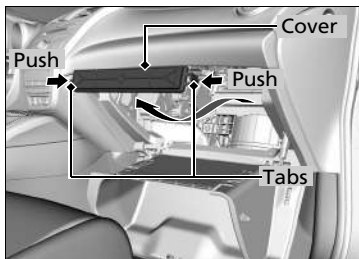

5. Push in the tabs on the corners of the filter case cover, and remove it.

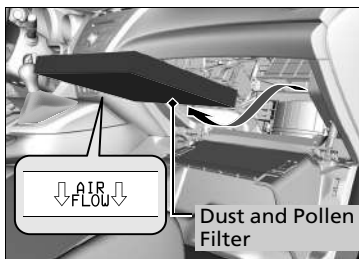

6. Remove the filter from the case.

7. Install a new filter in the case.

- Put the **AIR FLOW** arrow directed side down.

▣ Dust and Pollen Filter

If you are not sure how to replace the dust and pollen filter, have it replaced by a dealer.

Interior Care

Use a vacuum cleaner to remove dust before using a cloth.

Use a damp cloth with a mixture of mild detergent and warm water to remove dirt.

Use a clean cloth to remove detergent residue.

Cleaning Seat Belts

Use a soft brush with a mixture of mild soap and warm water to clean the seat belts. Let the belts air dry. Wipe the openings of the seat belt anchors using a clean cloth.

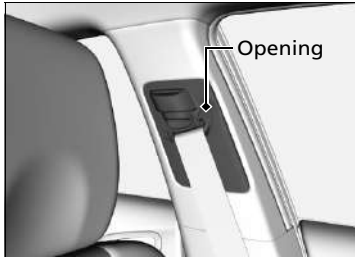

Cleaning the Windows

Wipe using a glass cleaner.

Interior Care

Do not spill liquids inside the vehicle.

Electrical devices and systems may malfunction if liquids are splashed on them.

Do not use silicone based sprays on electrical devices such as audio devices and switches.

Doing so may cause the items to malfunction or a fire inside the vehicle.

If a silicone based spray is inadvertently used on electrical devices, consult a dealer.

Depending on their composition, chemicals and liquid aromatics may cause discoloration, wrinkles, and cracking to resin-based parts and textiles. Do not use alkali solvents or organic solvents such as benzene or petrol.

After using chemicals, make sure to gently wipe them away using a dry cloth.

Do not place used cloths on top of resin based parts or textiles for long periods of time without washing.

Be careful not to spill a liquid type air freshener.

Cleaning the Windows

Wires are mounted to the inside of the rear window. Wipe along the same direction as the wires with a soft cloth so as not to damage them.

■ Floor Mats*

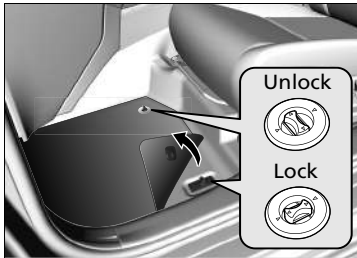

The front floor mats hook over the floor anchors, which keep the mats from sliding forward. To remove a mat for cleaning, turn the anchor knobs to the unlock position. When reinstalling the mat after cleaning, turn the knobs to the lock position.

Do not put additional floor mats on top of the anchored mats.

■ Maintaining Genuine Leather*

Vacuum dirt and dust from the leather frequently. Pay close attention to the pleats and seams. Clean the leather with a soft cloth dampened with a 90% water and 10% neutral soap solution. Then buff it with a clean, dry cloth. Remove any dust or dirt on leather surfaces immediately.

▣ Floor Mats*

If you use any floor mats that were not originally provided with your vehicle, make sure they are designed for your specific vehicle, fit correctly, and are securely anchored by the floor anchors. Position the rear seat floor mats properly. If they are not properly positioned, the floor mats can interfere with the front seat functions.

Exterior Care

Dust off the vehicle body after you drive.

Regularly inspect your vehicle for scratches on painted surfaces. A scratch on a painted surface can result in body rust. If you find a scratch, promptly repair it.

Washing the Vehicle

Wash the vehicle frequently. Further, make sure to wash the vehicle in the following circumstances:

- If driving on roads with road salt.
- If driving in coastal areas.
- If tar, soot, bird droppings, insects, or tree sap are stuck to painted surfaces.

Using an Automated Car Wash

- Make sure to follow the instructions indicated on the automated car wash.
- Remove the audio antenna.
 - ▣ **Audio Antenna*** P. 226
- Fold in the door mirrors.
- Turn off the automatic intermittent wipers*.

* Not available on all models

Washing the Vehicle

Except 2.0 L Petrol engine models

Do not spray water into the air intake vents. It can cause a malfunction.

Petrol models (2.0 L engine models)

Do not spray water into the air intake vents or engine compartment. It can cause a malfunction.

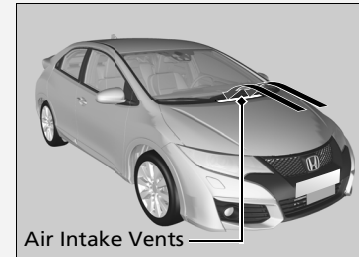

Continued

■ Using High Pressure Cleaners

- Keep sufficient distance between the cleaning nozzle and the vehicle body.
- Take particular care around the windows. Standing too close may cause water to enter the vehicle interior.

Except 2.0 L Petrol engine models

- Do not spray high pressure water directly into the engine compartment. Instead, use low pressure water and a mild detergent.

Petrol models (2.0 L engine models)

- Do not spray high pressure water directly into the engine compartment.

■ Applying Wax

A good coat of automotive body wax helps to protect your vehicle's paint from the elements. Wax will wear off over time and expose your vehicle's paint to the elements, so reapply as necessary.

■ Maintaining the Bumpers and Other Resin Coated Parts

If you get petrol, oil, engine coolant, or battery fluid on resin coated parts, they may be stained or the coating may peel. Promptly wipe it away using a soft cloth and water.

■ Cleaning the Windows

Wipe using a glass cleaner.

►► Applying Wax

NOTICE

Chemical solvents and strong cleaners can damage the paint, metal, and plastic on your vehicle. Wipe away spills immediately.

►► Maintaining the Bumpers and Other Resin Coated Parts

Ask a dealer about the correct coating material when you want to repair the painted surface of the parts made of resin.

■ Maintaining Aluminium Wheels

Aluminium is susceptible to deterioration caused by salt and other road contaminants. Use a sponge and mild detergent to wipe away promptly. Be careful not to use harsh chemicals (including some commercial wheel cleaners) or a stiff brush. They can damage the clear coat of the aluminium alloy wheels that helps to keep the aluminium from corroding and tarnishing.

■ Fogged Exterior Light Lenses

The inside lenses of exterior lights (headlights, brake lights, etc.) may fog temporarily if you have driven in the rain, or after the vehicle has been run through a car wash. Dew condensation also may build up inside the lenses when there is a significant enough difference between the ambient and inside lens temperatures (similar to vehicle windows fogging up in rainy conditions). These conditions are natural processes, not structural design problems in the exterior lights. Lens design characteristics may result in moisture developing on the light lens frame surfaces. This also is not a malfunction. However, if you see large amounts water accumulation, or large water drops building up inside the lenses, have your vehicle inspected by a dealer.

Handling the Unexpected

This chapter explains how to handle unexpected troubles.

Tools	
Types of Tools.....	556
If a Tyre Goes Flat	
Changing a Flat Tyre*	557
Temporarily Repairing a Flat Tyre*	565
Engine Does Not Start	
Checking the Engine	574
If the Keyless Remote Battery is Weak ...	576
Emergency Engine Stop	577
Jump Starting	578
Shift Lever Does Not Move	582
Overheating	
Petrol models	
How to Handle Overheating.....	583

Diesel models	
How to Handle Overheating.....	585
Indicator, Coming On/Blinking	
If the Low Oil Pressure Indicator Comes On....	587
If the Charging System Indicator Comes On...	587
If the Malfunction Indicator Lamp Comes On or Blinks.....	588
If the Brake System Indicator (Red) Comes On	588
If the Electric Power Steering (EPS) System Indicator Comes On	589
If the Low Tyre Pressure/Deflation Warning System Indicator Comes On or Blinks	590
If the Low Oil Level Symbol Appears	591

If the PGM-FI Symbol Appears.....	591
Fuses	
Fuse Locations	592
Inspecting and Changing Fuses.....	598
Emergency Towing	599
When You Cannot Open the Tailgate	601
Refueling	
Refueling From a Portable Fuel Container ...	602
Priming the Fuel System	
How to Bleed Air from the Fuel System	603

* Not available on all models

Types of Tools

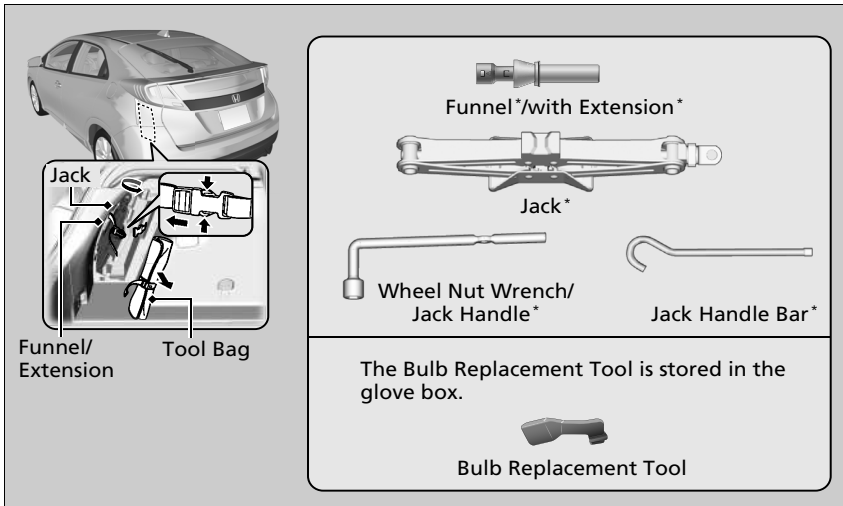

Types of Tools

The tools are stored in the luggage area.

If a Tyre Goes Flat

Changing a Flat Tyre*

If a tyre goes flat while driving, grasp the steering wheel firmly, and brake gradually to reduce speed. Then, stop in a safe place. Replace the flat tyre with a compact spare tyre. Go to a dealer as soon as possible to have the full-size tyre repaired or replaced.

1. Park the vehicle on firm, level, and non-slippery surface and apply the parking brake.

Automatic transmission models

2. Move the shift lever to **P**.

Manual transmission models

2. Move the shift lever to **R**.

All models

3. Turn on the hazard warning lights and turn the ignition switch to LOCK **0***1.

*1: Models with the keyless access system have an **ENGINE START/STOP** button instead of an ignition switch.

* Not available on all models

Changing a Flat Tyre*

Follow compact spare precautions:

Periodically check the tyre pressure of the compact spare*. It should be set to the specified pressure. Specified Pressure: 420 kPa (4.2 bar, 60 psi)

When driving with the compact spare tyre, keep the vehicle speed under 80 km/h (50 mph). Replace with a full-size tyre as soon as possible.

The compact spare tyre and wheel in your vehicle are specifically for this model. Do not use them with another vehicle. Do not use another type of compact spare tyre or wheel with your vehicle.

Do not mount tyre chains on a compact spare tyre. If a chain-mounted front tyre goes flat, remove one of the full-size rear tyres and replace it with the compact spare tyre. Remove the flat front tyre and replace it with the full-size tyre that was removed from the rear. Mount the tyre chains on the front tyre.

A compact spare tyre gives a harsher ride and less traction on some road surfaces. Use greater caution while driving.

Do not use more than one compact spare tyre at the same time.

The compact spare tyre is smaller than the regular tyre. Your vehicle's ground clearance reduces when the compact spare tyre is installed. Driving over road debris or bumps could possibly damage the underside of your vehicle.

Continued

Getting Ready to Replace the Flat Tyre

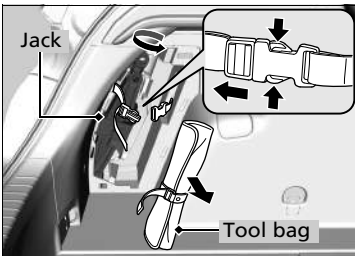
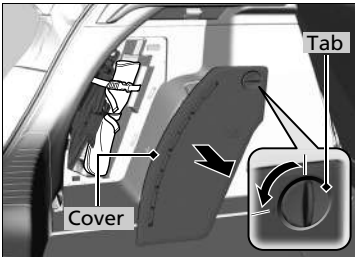
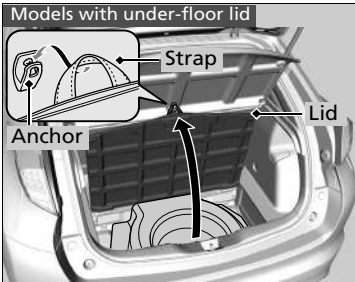

1. Open the tailgate.

Models with under-floor lid

2. Pull the strap and open the under-floor lid.
3. Hook the strap to the anchor as shown.

All models

4. Turn and pull the tab to open the compartment cover located on the left side of the luggage area.
5. Take the tool bag out of the compartment.
6. Turn the jack's end bracket to loosen it, then remove it.

Changing a Flat Tyre*

WARNING: The jack can only be used for helping an emergency vehicle breakdown, not for changing the regular seasonal tyre or any other normal maintenance or repair operation.

NOTICE

Do not use the jack if it doesn't work properly. Call your dealer or a professional towing service.

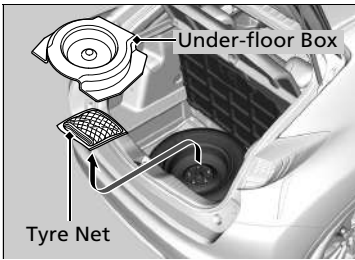

7. Remove the under-floor box, then take the tyre net out.
8. Unscrew the wing bolt, and remove the spacer cone. Remove the spare tyre.

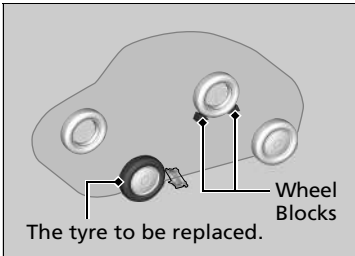

9. Place a wheel block or rock in front and rear of the wheel diagonal to the flat tyre.

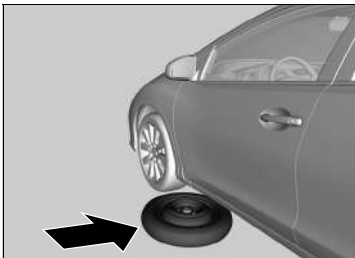

10. Place the spare tyre (wheel side up) under the vehicle body, near the tyre that needs to be replaced.



11. Loosen each wheel nut about one turn using the wheel nut wrench.

How to Set Up the Jack

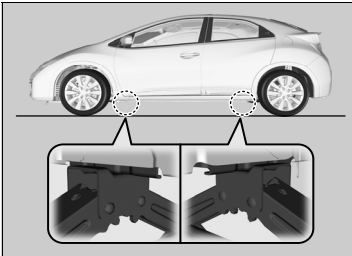

1. Place the jack under the jacking point closest to the tyre to be changed.

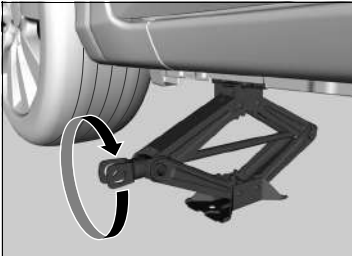

2. Turn the end bracket clockwise as shown in the image until the top of the jack contacts the jacking point.

▶ Make sure that the jacking point tab is resting in the jack notch.

How to Set Up the Jack

⚠ WARNING

The vehicle can easily roll off the jack, seriously injuring anyone underneath.

Follow the directions for changing a tyre exactly, and no person should place any portion of their body under a vehicle that is supported by a jack.

WARNING: The jack shall be placed on a flat and stable surface on the same level as the vehicle is parked.

The jack that came with your vehicle has the following label.

1.	2.	3.

1. See Owner's Manual.
2. Never get under vehicle when supported by jack.
3. Place jack underneath reinforced area.

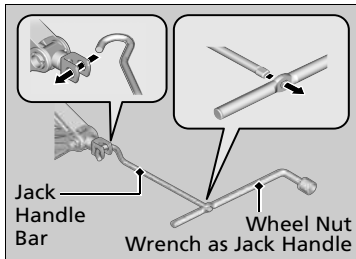

3. Raise the vehicle, using the jack handle bar and the jack handle, until the tyre is off the ground.

⌘ How to Set Up the Jack

Do not use the jack with people or luggage in the vehicle.

Use the jack provided in your vehicle. Other jacks may not support the weight ("load") or may not fit the jacking point.

The following instructions must be followed to use the jack safely:

- Do not use while the engine is running.
- Use only where the ground is firm and level.
- Use only at the jacking points.
- Do not get in the vehicle while using the jack.
- Do not put anything on top of or underneath the jack.

⌘ Replacing the Flat Tyre

Do not over tighten the wheel nuts by applying extra torque using your foot or a pipe.

■ Replacing the Flat Tyre

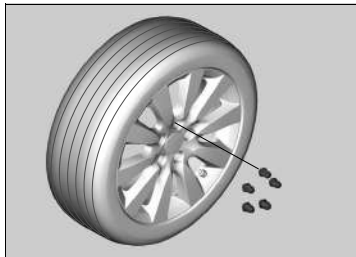

1. Remove the wheel nuts and flat tyre.

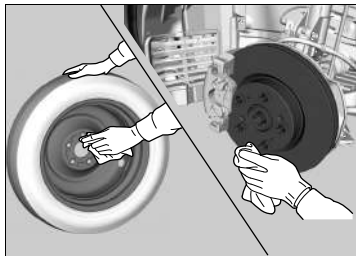

2. Wipe the mounting surfaces of the wheel with a clean cloth.
3. Mount the spare tyre.
4. Screw the wheel nuts until they touch the lips around the mounting holes, then stop rotating.

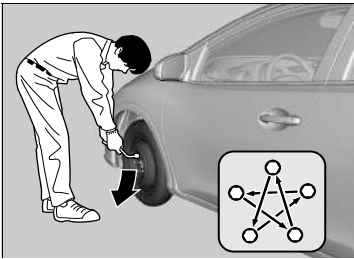

- Lower the vehicle and remove the jack. Tighten the wheel nuts in the order indicated in the image. Go around, tightening the nuts, two to three times in this order.

Wheel nut torque:

108 N·m (11 kgf·m, 80 lbf·ft)

■ Storing the Flat Tyre

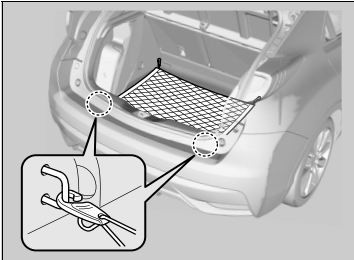

Models with under-floor lid

- Close the under-floor lid. Do not lower it.

All models

- Place the tyre net on the luggage area, then attach the two hooks to the luggage hooks on the tailgate opening.
- Place the flat tyre on the net.

Models without under-floor lid

- ▶ Make sure to place the tyre as rear as possible. The bottom side of the tyre should touch the rear inside wall.

▶▶ Storing the Flat Tyre

⚠ WARNING

Loose items can fly around the interior in a crash and can seriously injure the occupants.
Store the wheel, jack, and tools securely before driving.

Continued

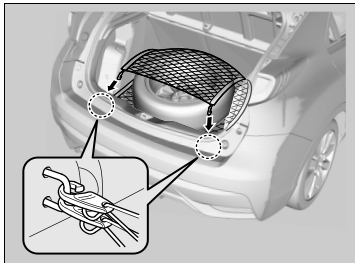

4. Wrap the flat tyre with the net, then attach the other two hooks to the same luggage hooks as shown.
5. Store the jack in the compartment on the left side. Turn the jack's end bracket to lock it in place.
6. Store the tool kit in the compartment.

■ Deflation Warning System and the Spare Tyre

If you replace a flat tyre with the spare tyre,  indicator comes on while you are driving. After driving for a few kilometres (miles), the indicator will start blinking for a short time and then stay on, but this is normal.

Calibrate the deflation warning system when you replace the tyre with a specified regular tyre.

➤ **Deflation Warning System Calibration** P. 428

Temporarily Repairing a Flat Tyre*

If the tyre has a large cut or is otherwise severely damaged, you will need to have the vehicle towed. If the tyre only has a small puncture, from a nail for instance, you can use the temporary tyre repair kit so that you can drive to the nearest service station for a more permanent repair.

If a tyre goes flat while driving, grasp the steering wheel firmly, and brake gradually to reduce speed. Then stop in a safe place.

1. Park the vehicle on firm, level, and non-slippery ground and apply the parking brake.

Automatic transmission models

2. Move the shift lever to **P**.

Manual transmission models

2. Move the shift lever to **R**.

All models

3. Turn on the hazard warning lights and turn the ignition switch to LOCK **0***1.
 - ▶ When towing a trailer, unhitch the trailer.

*1: Models with the keyless access system have an **ENGINE START/STOP** button instead of an ignition switch.

* Not available on all models

Continued

Temporarily Repairing a Flat Tyre*

The kit should not be used in the following situations. Instead, contact a dealer or roadside assistant to have the vehicle towed.

- The tyre sealant has expired.
- More than one tyre is punctured.
- The puncture or cut is greater than 4 mm (3/16 inch).
- The tyre side wall is damaged or the puncture is outside the tyre tread.

	When the puncture is:	Kit Use
	Smaller than 4 mm (3/16 inch)	Yes
	Larger than 4 mm (3/16 inch)	No



- Damage has been caused by driving with the tyres extremely under inflated.
- The tyre bead is no longer seated.
- The rim is damaged.

Do not remove a nail or screw that punctured the tyre. If you remove it from the tyre, you may not be able to repair the puncture using the kit.

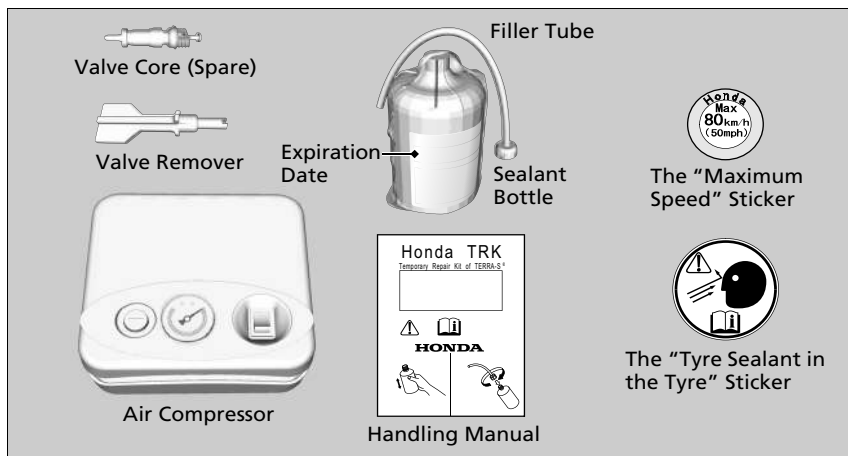
Getting Ready to Repair the Flat Tyre



Getting Ready to Repair the Flat Tyre

Read the handling manual that came with the kit carefully. Symbols   on the handling manual and the sealant bottle are to remind you to read this owner's manual for using the tyre sealant.

If adhered to clothes, the sealant may not come off. Do not spill any.

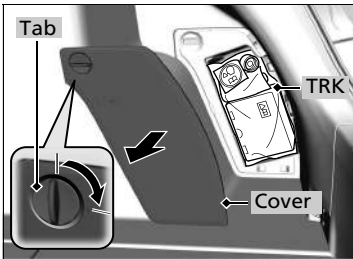

Models without premium audio

1. Open the tailgate.
2. Turn and pull the tab to open the compartment cover located on the right side of the luggage area.
3. Take the TRK out of the rear right side compartment.

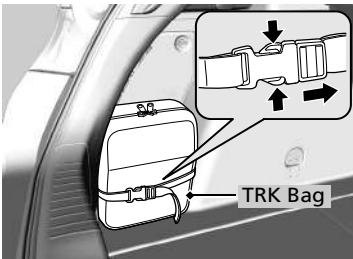

Models with premium audio

1. Open the tailgate.
2. Remove the TRK bag attached to the left side of the luggage area.

■ Injecting the Sealant

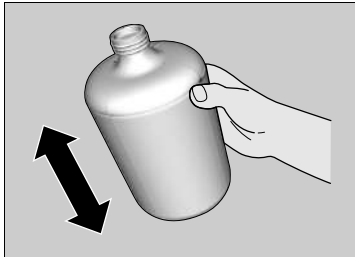

1. Shake the bottle well.

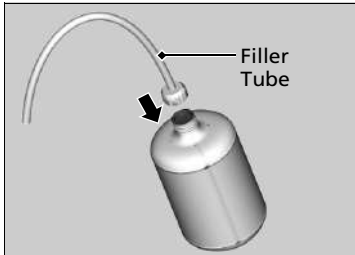

2. Screw the filler tube onto the bottle.

► It pierces the sealed aluminium on top of the bottle.

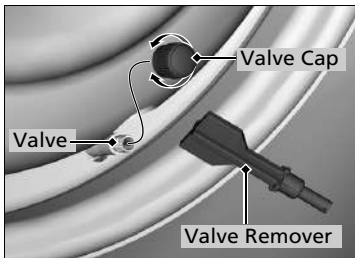

3. Unscrew the valve cap.

4. Deflate the tyre completely, using the flat end of the valve remover pushing on the valve core.

▣ Injecting the Sealant

⚠ WARNING

Tyre sealant contains substances that are harmful and can be fatal if swallowed.

If accidentally swallowed, do not induce vomiting. Drink plenty of water and get medical attention immediately.

For skin or eye contact, flush with cool water and get medical attention if necessary.

⚠ CAUTION

A valve core can jump out if air remains in tyre.

Extract the air of a tyre completely.

Keep the sealant bottle out of the reach of children. Do not shake the bottle after the filler tube is installed. If you shake the bottle after connecting the tube with the bottle, it may spill sealant.

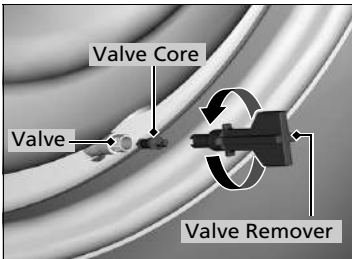

5. Unscrew the valve core using the valve remover. Do not place the valve core in sand or dirt.

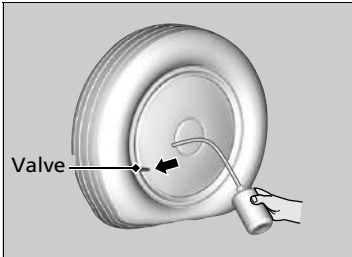

6. Screw the filler tube onto the tyre valve.

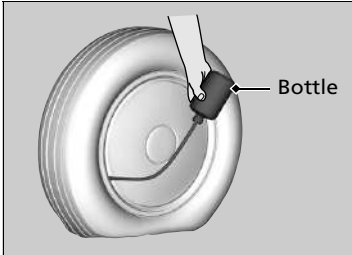

7. Hold the bottle upside down, and inject the sealant completely.

► Squeeze the bottle until the sealant is injected completely.

8. Pull off the filler tube.

✕ Injecting the Sealant

The sealant can permanently stain clothing and other materials. Be careful during handling and wipe away any spills immediately.

Continued

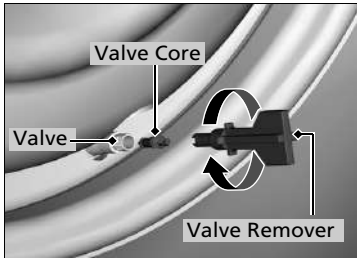

9. Firmly screw the valve core into the tyre stem using the valve remover.

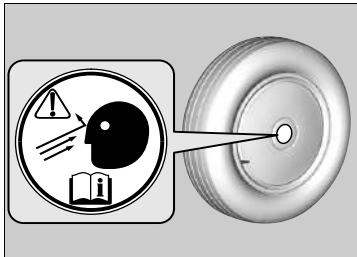

10. Apply the tyre sealant in the tyre sticker to the flat surface of the wheel.
► The wheel surface must be clean to ensure the sticker adheres properly.

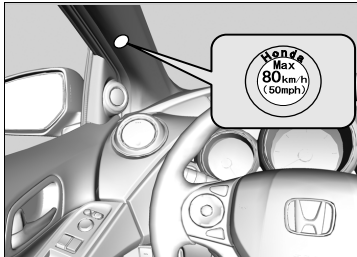

11. Apply the maximum speed sticker to the location shown.

► Injecting the Sealant

After injection, insert the valve remover into the filler tube. This prevents the remaining sealant from spilling out.

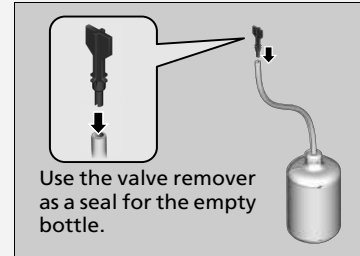

Keep the empty bottle after the sealant is injected. The sealant bottle will be used to collect the injected sealant by a professional.

See a Honda dealer for a replacement sealant bottle and proper disposal of an empty bottle.

■ Inflating the Tyre

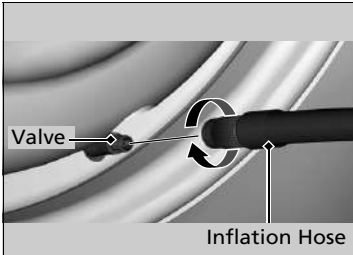

1. Attach the inflation hose to the valve. Screw it until it is tight.

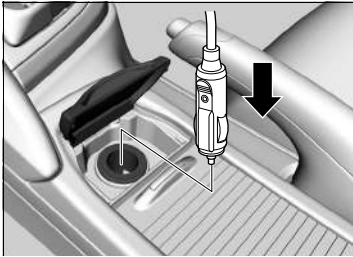

2. Plug in the air compressor to the accessory power socket.
 - ▶ Be careful not to pinch the cord in a door or window.
 - ▶ **Accessory Power Sockets** P. 208
3. Turn the ignition switch to ACCESSORY *1.
 - ▶ In freezing temperatures, start the engine on and leave it running while the flat tyre is being serviced.
 - ▶ **Carbon Monoxide Gas** P. 79

▣ Inflating the Tyre

⚠ WARNING

Running the engine with the vehicle in an enclosed or even partly enclosed area can cause a rapid build-up of toxic carbon monoxide. Breathing this colourless, odourless gas can cause unconsciousness and even death. Only run the engine to power the air compressor with the vehicle outdoors.

NOTICE

Do not operate the temporary tyre repair kit compressor for more than 15 minutes. The compressor can overheat and become permanently damaged.

See the driver's doorjamb for the required air pressure.

If you want to measure the air pressure using a gauge, turn the air compressor off first.

The power supply of the air compressor is limited to your vehicle's 12-volt DC accessory socket.

*1: Models with the keyless access system have an **ENGINE START/STOP** button instead of an ignition switch.

Continued

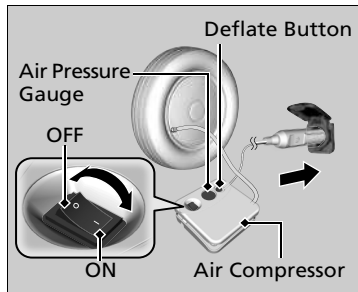

4. Turn on the air compressor and inflate the tyre to the required air pressure.
 - ▶ Check the air pressure gauge on the air compressor.
 - ▶ If overinflated, press the pressure deflate button.
5. Turn off the air compressor. Reinstall the valve cap.
6. Unplug the kit from the accessory power socket.
7. Unscrew the inflation hose from the tyre valve. Reinstall the valve cap.

▣ Inflating the Tyre

See the driver's doorjamb for the required air pressure.

If the required air pressure is not reached within 10 minutes, the tyre may be severely damaged for the kit to provide the necessary seal and your vehicle will need to be towed.

■ Distributing the Sealant in the Tyre

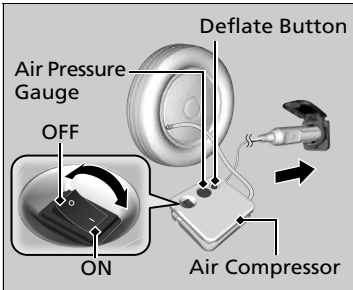
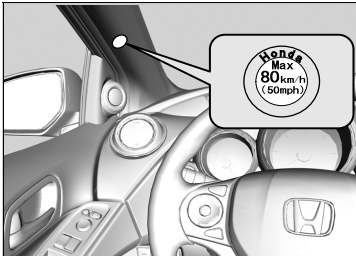

1. Drive the vehicle for about 10 minutes or five kilometres (three miles).
 - ▶ Do not exceed 80 km/h (50 mph).
2. Stop the vehicle at a safe place.
3. Check the air pressure using the gauge on the air compressor.
 - ▶ Do not turn the air compressor on to check the pressure.
4. If the air pressure is
 - Less than 130 kPa (19 psi): Do not add air and continue driving. The leak is too severe. Call for help and have your vehicle towed.
 - ✦ **Emergency Towing** P. 599
 - Required air pressure or more: Continue driving until you reach the nearest service station. Do not exceed 80 km/h (50 mph).
 - Greater than 130 kPa (19 psi), but less than required air pressure: Inflate the tyre to the required air pressure.
 - ✦ **Inflating the Tyre** P. 571

And repeat steps 1 to 3 until you reach the nearest service station. Do not exceed 80 km/h (50 mph).
5. Repackage and properly stow the kit.

Engine Does Not Start

Checking the Engine

If the engine does not start, check the starter.

☞ Checking the Engine

If you must start the vehicle immediately, use an assisting vehicle to jump start it.

☞ **Jump Starting** P. 578

Starter condition

Checklist

Starter doesn't turn or turns over slowly.

The battery may be dead. Check each of the items on the right and respond accordingly.

The starter turns over normally but the engine doesn't start.

There may be a problem with the fuse. Check each of the items on the right and respond accordingly.

Check the brightness of the interior lights.

Turn on the interior lights and check the brightness.

- If the interior lights are dim or do not come on at all
☞ **Battery** P. 540
- If the interior lights come on normally ☞ **Fuses** P. 592

Review the engine start procedure.

Follow its instructions, and try to start the engine again. ☞ **Starting the Engine** P. 382, 385

Check the immobilizer system indicator.

When the immobilizer system indicator is blinking, the engine cannot be started.

☞ **Immobilizer System** P. 162

Check the fuel level.

There should be enough fuel in the tank. ☞ **Fuel Gauge** P. 119

Check the fuses.

Check all fuses, or have your vehicle checked by a dealer.

☞ **Inspecting and Changing Fuses** P. 598

If the problem continues:

☞ **Emergency Towing** P. 599

*1: Models with the keyless access system have an **ENGINE START/STOP** button instead of an ignition switch.

Starter condition	Checklist
<p>The starter turns over normally but the engine doesn't start. There may be a problem with the fuses. Check each of the items on the right and respond accordingly.</p>	<p>Diesel models with fuel system primer Prime the fuel system if the malfunction indicator lamp comes on, or PGM-FI appears on the i-multi-information display when the fuel tank has been run dry.</p> <ul style="list-style-type: none"> ➤ Priming the Fuel System P. 603 ➤ i-Multi-Information Display Warning and Information Messages P. 115
	<p>Diesel models without fuel system primer Have your vehicle checked by a dealer. If the malfunction indicator lamp comes on, or PGM-FI appears on the i-multi-information display under the following circumstances:</p> <ul style="list-style-type: none"> • The fuel tank has been run dry. ➤ i-Multi-Information Display Warning and Information Messages P. 115
	<p>Diesel models Have the fuel filter checked by a dealer to drain off water.</p> <p> appears on the i-multi-information display.</p> <ul style="list-style-type: none"> ➤ Draining Water P. 115 ➤ i-Multi-Information Display Warning and Information Messages P. 115

Model with keyless access system

If the Keyless Remote Battery is Weak

If the beeper sounds,  appears on the i-multi-information display, and the indicator on the **ENGINE START/STOP** button blinks, the engine does not start. Start the engine as follows.

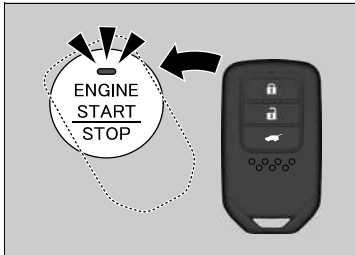

1. Touch the centre of the **ENGINE START/STOP** button with the **H** logo on the keyless remote while the indicator on the **ENGINE START/STOP** button is blinking. The buttons on the keyless remote should be facing you.

▶ The indicator blinks for about 30 seconds.

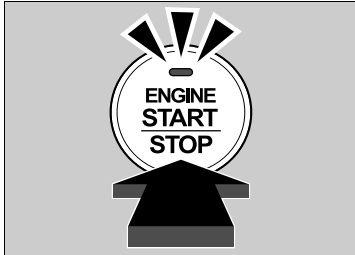

2. Depress the brake pedal (automatic transmission) or clutch pedal (manual transmission) and press the **ENGINE START/STOP** button within 10 seconds after the beeper sounds and the indicator stays on.

▶ If you do not depress the pedal, the mode changes to **ACCESSORY**.

Model with keyless access system

Emergency Engine Stop

The **ENGINE START/STOP** button may be used to stop the engine due to an emergency situation even while driving. If you must stop the engine, do either of the following operations:

- Press and hold the **ENGINE START/STOP** button for about two seconds.
- Firmly press the **ENGINE START/STOP** button twice.

The steering wheel will not lock.

Automatic transmission models

The power mode is in ACCESSORY when the engine is stopped. To change the mode to VEHICLE OFF, move the shift lever to **[P]** after the vehicle comes to a complete stop. Then press the **ENGINE START/STOP** button twice without depressing the brake pedal.

Manual transmission models

The power mode changes to VEHICLE OFF. The vehicle comes to a complete stop. After press the **ENGINE START/STOP** button three times without depressing the clutch pedal.

- ▶ The steering wheel will lock.

Emergency Engine Stop

Do not press the button while driving unless it is absolutely necessary for the engine to be switched off.

Jump Starting Procedure

Turn off the power to electric devices, such as audio and lights. Turn off the engine, then open the bonnet.

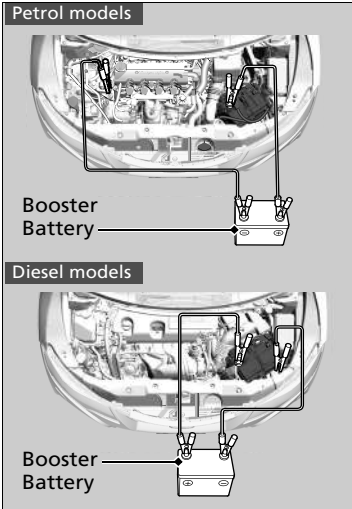

1. Connect the first jumper cable to your vehicle's battery \oplus terminal.
2. Connect the other end of the first jumper cable to the booster battery \oplus terminal.
 - ▶ Use a 12 volt booster battery only.
 - ▶ When using an automotive battery charger to boost your 12 volt battery, select a lower charging voltage than 15 volt. Check the charger manual for the proper setting.
3. Connect the second jumper cable to the booster battery \ominus terminal.

Jump Starting

WARNING

A battery can explode if you do not follow the correct procedure, seriously injuring anyone nearby.

Keep all sparks, open flames, and smoking materials away from the battery.

NOTICE

If a battery sits in extreme cold, the electrolyte inside can freeze. Attempting to jump start with a frozen battery can cause it to rupture.

Securely attach the jumper cables clips so that they do not come off when the engine vibrates. Also be careful not to tangle the jumper cables or allow the cable ends to touch each other while attaching or detaching the jumper cables.

Battery performance degrades in cold conditions and may prevent the engine from starting.

Petrol models (1.4 L engine models)

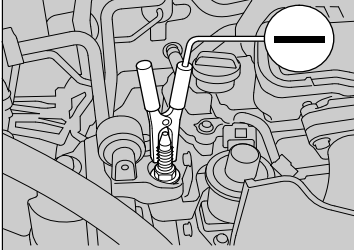

Petrol models (1.8 L engine models)

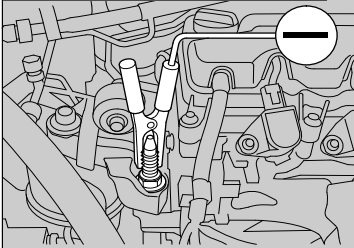

4. Connect the other end of the second jumper cable to:

Petrol models

The engine mounting bolt as shown.

Diesel models

The grounding point as shown.

Do not connect this jumper cable to any other part.

5. If the jumper cable is connected to another vehicle, start the assisting vehicle's engine and increase engine's revolution slightly.
6. Attempt to start your vehicle's engine. If it turns over slowly, check that the jumper cables have good metal-to-metal contact.

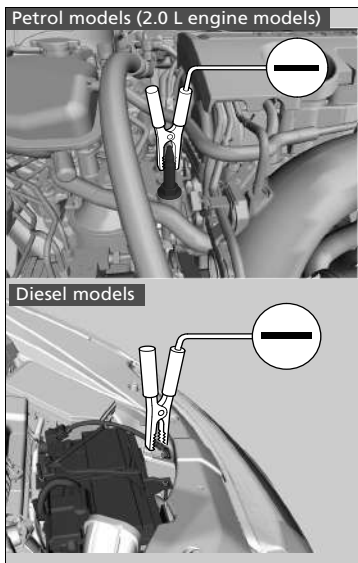

■ What to Do After the Engine Starts

Once your vehicle's engine has started, remove the jumper cables in the following order.

1. Disconnect the jumper cable from your vehicle's ground.
2. Disconnect the other end of the jumper cable from the booster battery \ominus terminal.
3. Disconnect the jumper cable from your vehicle's battery \oplus terminal.
4. Disconnect the other end of the jumper cable from the booster battery \oplus terminal.

Have your vehicle inspected by a nearby service station or a dealer.

Shift Lever Does Not Move

Automatic transmission models

Follow the procedure below if you cannot move the shift lever out of the **P** position.

Releasing the Lock



1. Set the parking brake.

Models without keyless access system

2. Remove the key from the ignition switch.

Models with keyless access system

2. Remove the built-in key from the keyless remote.

All models

3. Wrap a cloth around the tip of a small flat-tip screwdriver. Put it into the shift lock release slot as shown in the image, and remove the cover.

4. Insert the key into the shift lock release slot.
5. While pushing the key down, press the shift lever release button and place the shift lever into **N**.

▶ The lock is now released. Have the shift lever checked by a dealer as soon as possible.

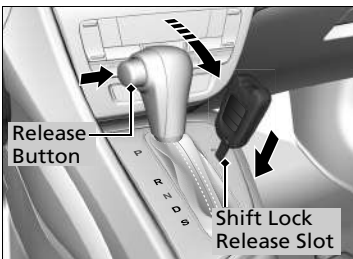

Overheating

Petrol models except 2.0 L engine models

How to Handle Overheating

Overheating symptoms are as follows:

- The temperature gauge needle is at the red (Hot) mark or the engine suddenly loses power.
- Steam or spray comes out of the engine compartment.

■ First thing to do

1. Immediately park the vehicle in a safe place.
2. Turn off all accessories and turn on the hazard warning lights.
 - ▶ **No steam or spray present:** Keep the engine running and open the bonnet.
 - ▶ **Steam or spray present:** Turn off the engine and wait until it subsides. Then, open the bonnet.

How to Handle Overheating

WARNING

Steam and spray from an overheated engine can seriously scald you.

Do not open the bonnet if steam is coming out.

NOTICE

Continuing to drive with the temperature gauge needle at the red (Hot) mark on may damage the engine.

Continued

■ Next thing to do

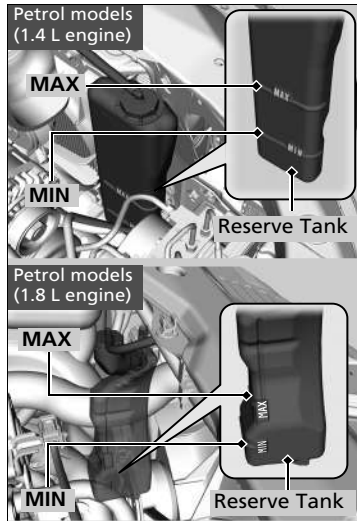

1. Check that the cooling fan is operating and stop the engine once the temperature gauge needle goes down.
 - If the cooling fan is not operating, immediately stop the engine.
2. Once the engine has cooled down, inspect the coolant level and check the cooling system components for leaks.
 - If the coolant level in the reserve tank is low, add coolant until it reaches the **MAX** mark.
 - If there is no coolant in the reserve tank, check that the radiator is cool. Cover the radiator cap with a heavy cloth and open the cap. If necessary, add coolant up to the base of the filler neck, and put the cap back on.

■ Last thing to do

Once the engine has cooled sufficiently, restart it and check the temperature gauge. If the temperature gauge needle has gone down, resume driving. If it has not gone down, contact a dealer for repairs.

► How to Handle Overheating

⚠ WARNING

Removing the radiator cap while the engine is hot can cause the coolant to spray out, seriously scalding you.

Always let the engine and radiator cool down before removing the radiator cap.

If the coolant is leaking, contact a dealer for repairs.

Use water as an emergency/temporary measure only. Have a dealer flush the system with proper antifreeze as soon as possible.

Diesel models and Petrol models (2.0 L engine models)

How to Handle Overheating

Overheating symptoms are as follows:

- The temperature gauge needle is at the red (Hot) mark or the engine suddenly loses power.
- Steam or spray comes out of the engine compartment.

■ First thing to do

1. Immediately park the vehicle in a safe place.
2. Turn off all accessories and turn on the hazard warning lights.
 - ▶ **No steam or spray present:** Keep the engine running and open the bonnet.
 - ▶ **Steam or spray present:** Turn off the engine and wait until it subsides. Then, open the bonnet.

How to Handle Overheating

⚠ WARNING

Steam and spray from an overheated engine can seriously scald you.

Do not open the bonnet if steam is coming out.

NOTICE

Continuing to drive with the temperature gauge needle at the red (Hot) mark on may damage the engine.

Continued

■ Next thing to do

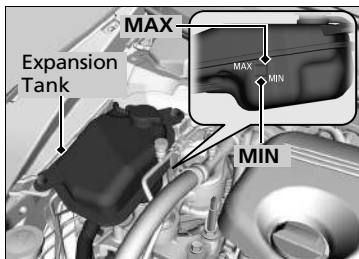

1. Check that the cooling fan is operating and stop the engine once the temperature gauge needle goes down.
 - If the cooling fan is not operating, immediately stop the engine.
2. Once the engine has cooled down, inspect the coolant level and check the cooling system components for leaks.
 - If the coolant level in the expansion tank is low, add coolant until it reaches the **MAX** mark. Cover the expansion tank cap with a heavy cloth. Loosen the cap by turning it 1/8 turn anticlockwise. Stop and wait for any pressure in the expansion tank to escape. Then remove the cap by turning it anticlockwise. Put the cap back on tightly filling the coolant.

■ Last thing to do

Once the engine has cooled sufficiently, restart it and check the temperature gauge. If the temperature gauge needle has gone down, resume driving. If it has not gone down, contact a dealer for repairs.

► How to Handle Overheating

⚠ WARNING

Removing the expansion tank cap while the engine is hot can cause the coolant to spray out, seriously scalding you.

Always let the engine and radiator cool down before removing the expansion tank cap.

If the coolant is leaking, contact a dealer for repairs.

Use water as an emergency/temporary measure only. Have a dealer flush the system with proper antifreeze as soon as possible.

If the Low Oil Pressure Indicator Comes On



■ Reasons for the indicator to come on

Comes on when the engine oil pressure is low.

■ What to do as soon as the indicator comes on

1. Immediately park the vehicle on level ground in a safe place.
2. If necessary, turn the hazard warning lights on.

■ What to do after parking the vehicle

1. Stop the engine and let it sit for about three minutes.
2. Open the bonnet and check the oil level.
 - 📖 **Oil Check** P. 498
3. Start the engine and check the low oil pressure indicator.
 - ▶ The indicator goes off: Start driving again.
 - ▶ The indicator does not go off within 10 seconds: Stop the engine and contact a dealer for repairs immediately.

If the Charging System Indicator Comes On



■ Reasons for the indicator to come on

Comes on when the battery is not being charged.

■ What to do when the indicator comes on

Turn off the climate control system, rear demister, and other electrical systems, and immediately contact a dealer for repairs.

☒ If the Low Oil Pressure Indicator Comes On

NOTICE

Running the engine with low oil pressure can cause serious mechanical damage almost immediately.

☒ If the Charging System Indicator Comes On

If you need to stop temporarily, do not turn off the engine. Restarting the engine may rapidly discharge the battery.

If the Malfunction Indicator Lamp Comes On or Blinks



■ Reasons for the indicator lamp to come on or blink

- Comes on if there is a problem with the engine emissions control system.
- Blinks when engine misfiring is detected.

Diesel models

- Comes on when air may have entered the fuel system.

■ What to do when the indicator lamp comes on

Avoid high speeds and immediately get your vehicle inspected at a dealer.

Diesel models with fuel system primer

Prime the fuel system. If it stays on, avoid high speeds and immediately get your vehicle inspected at a dealer.

🔧 **Priming the Fuel System** P. 603

■ What to do when the indicator lamp blinks

Park the vehicle in a safe place with no flammable items and wait at least 10 minutes or more with the engine stopped until it cools.

▶▶ If the Malfunction Indicator Lamp Comes On or Blinks

NOTICE

If you drive with the malfunction indicator lamp on, the emissions control system and the engine could be damaged.

If the malfunction indicator lamp blinks again when restarting the engine, drive to the nearest dealer at 50 km/h (30 mph) or less. Have your vehicle inspected.

If the Brake System Indicator (Red) Comes On



■ Reasons for the indicator to come on

- The brake fluid is low.
- There is a malfunction in the brake system.

■ What to do when the indicator comes on while driving

Press the brake pedal lightly to check pedal pressure.

- If normal, check the brake fluid level the next time you stop.
- If abnormal, take immediate action. If necessary, downshift the transmission to slow the vehicle using engine braking.

▶▶ If the Brake System Indicator (Red) Comes On

Have your vehicle repaired immediately. It is dangerous to drive with low brake fluid. If there is no resistance from the brake pedal, stop immediately in a safe place. If necessary downshift the gears.

If the brake system indicator and **ABS** indicator come on simultaneously, the electronic brake distribution system is not working. This can result in vehicle instability under sudden braking. Have your vehicle inspected by a dealer immediately.

If the Electric Power Steering (EPS) System Indicator Comes On



■ Reasons for the indicator to come on

- Comes on if there is a problem with the EPS system.
- If you depress the accelerator pedal repeatedly to increase the engine speed while the engine is idling, the indicator comes on, and sometimes the steering wheel becomes harder to operate.

■ What to do when the indicator comes on

Stop the vehicle in a safe place and restart the engine.

If the indicator comes on and stays on, immediately have your vehicle inspected by a dealer.

If the Low Tyre Pressure/Deflation Warning System Indicator Comes On or Blinks



■ Reasons for the indicator to come on/blink

A tyre pressure is significantly low, or the deflation warning system has not been calibrated. If there is a problem with the deflation warning system or the compact spare tyre* is installed, the indicator blinks for about one minute, and then stays on.

■ What to do when the indicator comes on

Drive carefully and avoid abrupt cornering and hard braking. Stop your vehicle in a safe place. Check the tyre pressure and adjust the pressure to the specified level. The specified tyre pressure is on a label on the driver side doorjamb.

- ▶ Calibrate the deflation warning system after the tyre pressure is adjusted.

➤ **Deflation Warning System Calibration** P. 428

■ What to do when the indicator blinks, then remains on

Have the tyre inspected by a dealer as soon as possible. If the compact spare tyre* causes the indicator to blink, change the tyre to a full-size tyre.

The indicator goes off after driving for a few kilometres (miles).

- ▶ Calibrate the deflation warning system after a full-size tyre is reinstalled.

➤ **Deflation Warning System Calibration** P. 428

▶▶ If the Low Tyre Pressure/Deflation Warning System Indicator Comes On or Blinks

NOTICE

Driving on an extremely underinflated tyre can cause it to overheat. An overheated tyre can fail. Always inflate your tyres to the prescribed level.

If the Low Oil Level Symbol Appears



■ Reasons for the symbol to appear

Appears when the engine oil level is low.

■ What to do as soon as the symbol appears

1. Immediately park the vehicle on level ground in a safe place.
2. If necessary, turn the hazard warning lights on.

■ What to do after parking the vehicle

1. Stop the engine and let it sit for about three minutes.
2. Open the bonnet and check the oil level.

➤ **Oil Check** P. 498

Diesel models

If the PGM-FI Symbol Appears



■ Reasons for the symbol to appear while the engine is running

There is a problem with the engine control system.

■ What to do when the symbol appears repeatedly

Avoid full-throttle acceleration and high speed driving. Have your vehicle checked by a dealer.

▶▶ If the Low Oil Level Symbol Appears

NOTICE

Running the engine with low oil level can cause serious mechanical damage almost immediately.

This system activates after the engine warms up. If the outside temperature is extremely low, you may have to drive for a long time until the system senses the engine oil level.

If the indicator appears again, stop the engine and contact a dealer for repairs immediately.

▶▶ If the PGM-FI Symbol Appears

NOTICE

Continuously driving with this symbol on can damage the emissions controls and engine. Those repairs may not be covered by your vehicle's warranties.

Fuse Locations

If any electrical devices are not working, turn the ignition switch to LOCK **0***¹ and check to see if any applicable fuse is blown.

■ Primary Engine Compartment Fuse Box

Located near the battery. Push the tabs to open the box.

Fuse locations are shown on the image below.

Locate the fuse in question by the fuse number in the image and chart.

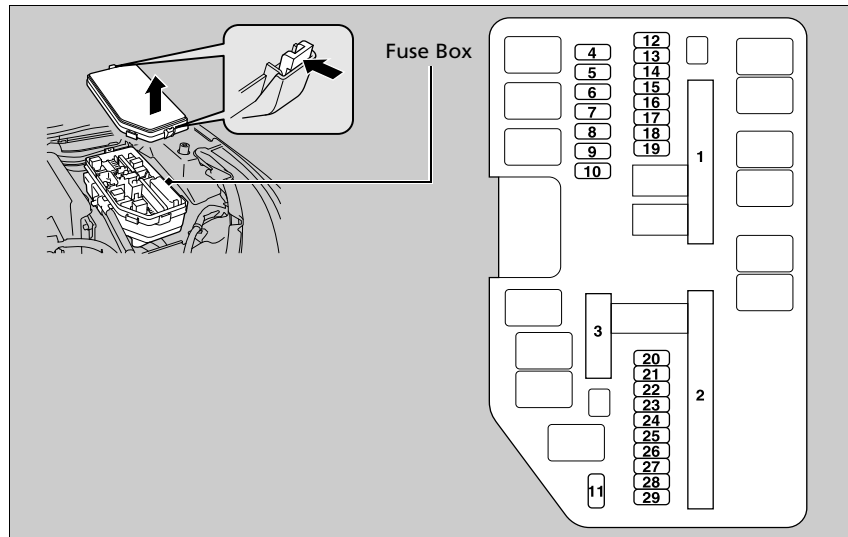

*1: Models with the keyless access system have an **ENGINE START/STOP** button instead of an ignition switch.

■ **Circuit protected and fuse rating**

	Circuit protected	Amps
1	EPS	70 A
	–	(30 A) ^{*1}
	–	(40 A) ^{*2}
	Glow	(70 A) ^{*3}
	ABS/VSA Motor	40 A
	ABS/VSA FSR	20 A
	ST/MG SW*	(30 A)
		100 A ^{*1}
	Main Fuse	120 A ^{*2}
		150 A ^{*3}
2	IG Main 1	50 A
	Fuse Box Main 1	60 A
	Fuse Box Main 2*	(40 A)
	Headlight Main	30 A
	DC/DC 1	30 A
	Rear Demister	30 A
	DC/DC 2	30 A
	Heater Motor	40 A
	IGN MAIN 2*	(30 A)
	Sub Fan Motor	20 A ^{*1} 30 A ^{*2, *3}
Main Fan Motor	20 A ^{*1} 30 A ^{*2, *3}	

	Circuit protected	Amps
3	PTC Heater 1 ^{*3}	(40 A)
	PTC Heater 2 ^{*3}	(40 A)
	PTC Heater 3 ^{*3}	(40 A)
	PTC Heater 4 ^{*3}	(40 A)
4	IGPS	7.5 A
5	ST MOT Fuse, STRLD	7.5 A
6	–	–
7	–	–
8	–	–
9	–	–
10	–	–
11	Back Up 2	10 A
12	Front Fog Lights*	(20 A)
13	ADS*	10 A
14	Hazard	15 A
15	IGP 2 ^{*1, *2}	15 A
	LAF Sensor ^{*3}	10 A
16	IG Coil ^{*1, *2}	15 A
	IGP 2 ^{*3}	15 A
17	Stop	10 A
18	Horn	10 A
19	–	–
20	Right Headlight Low Beam	10 A ^{*4} 15 A ^{*5}
21	FI Main	15 A ^{*1} 20 A ^{*2, *3}

	Circuit protected	Amps
22	DBW*	15 A
	Back Up FIECU*	7.5 A
23	Left Headlight Low Beam	10 A ^{*4} 15 A ^{*5}
24	Headlight Washer*	(30 A)
25	MG Clutch	7.5 A
26	Washer Main	20 A
27	Small Main	20 A
28	Interior Lights	10 A
29	Back Up	10 A

- *1: Petrol models except 2.0 L engine models
- *2: 2.0 L petrol engine models
- *3: Diesel models
- *4: Models with halogen headlights
- *5: Models with LED headlights

* Not available on all models

Secondary Engine Compartment Fuse Box

Located near the ⊕ terminal on the battery.

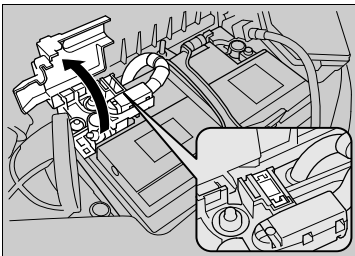

Pull up the cover.

Replacement of this fuse should be done by a dealer.

Fuse location is shown on the fuse box cover.

■ Circuit protected and fuse rating

	Circuit protected	Amps
	Battery	100 A ^{*1} 150 A ^{*2}

*1: Petrol models except 2.0 L engine models

*2: Diesel models and 2.0 L petrol engine models

■ Driver Side Interior Fuse Box

Located under the dashboard.

Fuse locations are shown on the image below.

Locate the fuse in question by the fuse number in the image and chart.

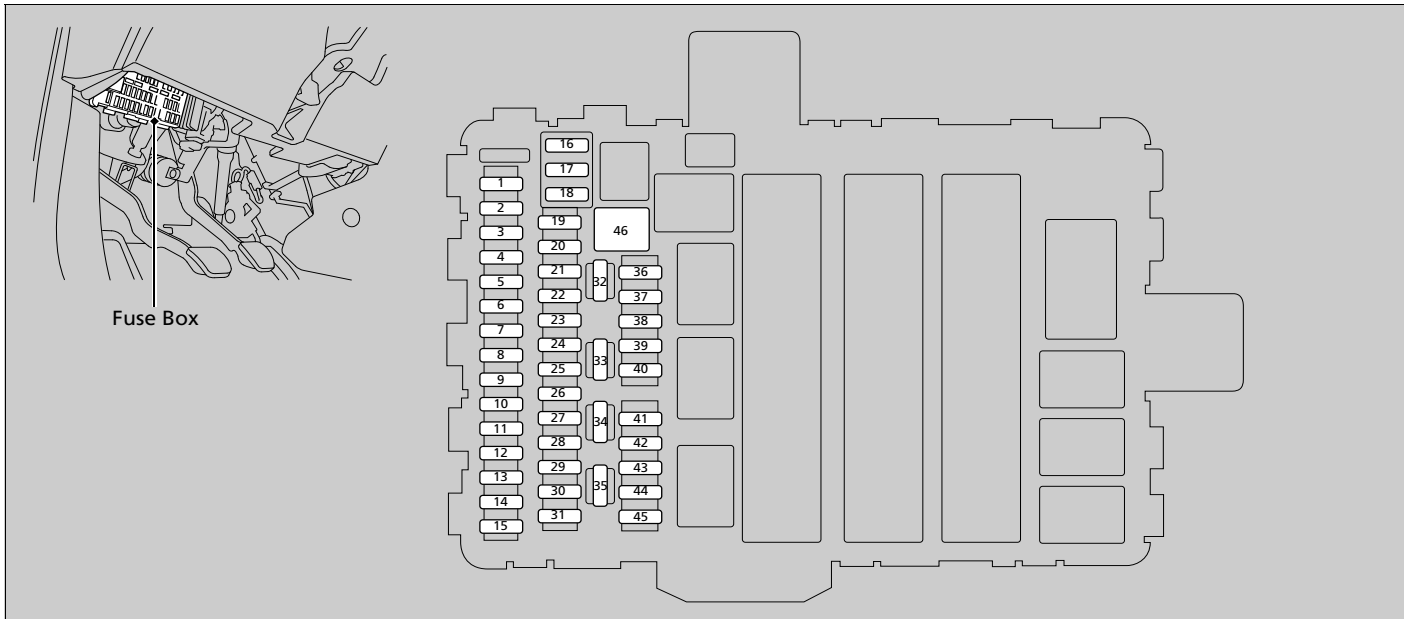

■ **Circuit protected and fuse rating**

	Circuit protected	Amps
1	–	–
2	ACG	10 A
3	SRS	10 A
4	Fuel Pump	15 A
5	Sub Fuse Box	7.5 A
6	Option	7.5 A
7	VB SOL*	(15 A)
8	Door Lock Motor 2 (Unlock)	15 A
9	Door Lock Motor 1 (Unlock)	15 A
10	Lumbar Support* Side Support*	(7.5 A)
11	Sunshade*	(20 A)
12	Accessory Power Socket (Console Compartment)*	(20 A)
13	Accessory Power Socket (Luggage Area)*	(20 A)
14	Seat Heaters*	(15 A)
15	Driver's Door Lock Motor (Unlock)	10 A
16	–	–
17	–	–
18	–	–
19	ACC	7.5 A
20	ACC Key Lock	7.5 A
21	Daytime Running Lights	7.5 A
22	HAC	7.5 A

	Circuit protected	Amps
23	Rear Wiper*	(10 A)
24	Sub Fuse Box	7.5 A
25	ACC*	(7.5 A)
26	Super Locking*	(20 A)
27	Accessory Power Socket (Front Console)	20 A
28	Washer*	15 A
29	ODS	7.5 A
30	Driver's Door Lock Motor (Lock)	10 A
31	Smart*	(7.5 A)
32	Door Lock Motor 2 (Lock)	15 A
33	Door Lock Motor 1 (Lock)	15 A
34	Small Lights	7.5 A
35	Illumination	7.5 A
36	Rear Wiper Main*	(10 A)
37	Daytime Running Light	7.5 A
38	Left Headlight High Beam	10 A
39	Right Headlight High Beam	10 A
40	Rear Fog Light	7.5 A
41	Door Lock	20 A
42	Driver's Power Window	20 A
43	Rear Right Side Power Window	20 A
44	Front Passenger's Side Power Window	20 A
45	Rear Left Side Power Window	20 A

	Circuit protected	Amps
46	Front Wiper	30 A

* Not available on all models

■ Passenger Side Interior Fuse Box

Located near the lower side panel.

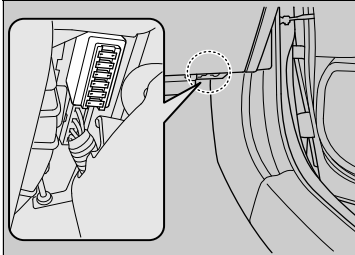

Fuse locations are shown on the image. Locate the fuse in question by the fuse number in the image and chart.

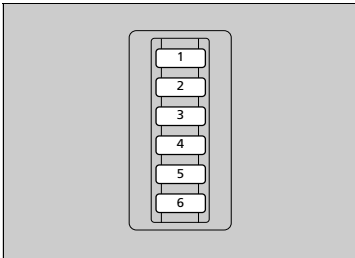

■ Circuit protected and fuse rating

	Circuit protected	Amps
1	Meter	7.5 A
2	ABS/VSA	7.5 A
3	MICU	7.5 A
4	Back Up 2 Main	15 A
5	ACC Radio	7.5 A
6	Audio Amp	20 A

Inspecting and Changing Fuses

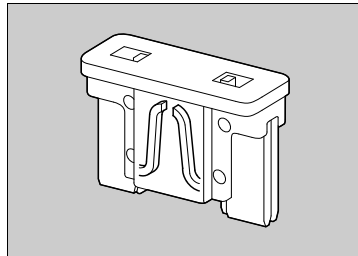
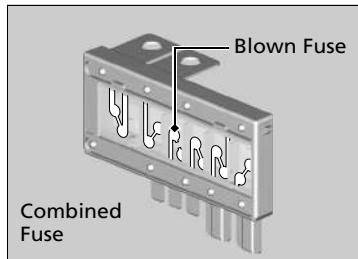

1. Turn the ignition switch to LOCK [0]*1. Turn headlights and all accessories off.
2. Remove the fuse box cover.
3. Check the large fuse in the engine compartment.
 - If the fuse is blown, use a Phillips-head screwdriver to remove the screw and replace it with a new one.
4. Inspect the small fuses in the engine compartment and the vehicle interior.
 - If there is a burned out fuse, remove it and replace it with a new one.

► Inspecting and Changing Fuses

NOTICE

Replacing a fuse with one that has a higher rating greatly increases the chances of damaging the electrical system.

Replace fuse with a new one of the same specified amperage.

Use the charts to locate the fuse in question and confirm the specified amperage.

► **Fuse Locations** P. 592

*1: Models with the keyless access system have an **ENGINE START/STOP** button instead of an ignition switch.

Call a professional towing service if you need to tow your vehicle.

■ Flat bed equipment

The operator loads your vehicle on the back of a truck.

This is the best way to transport your vehicle.

■ Wheel lift equipment

The tow truck uses two pivoting arms that go under the front tyres and lift them off the ground. The rear tyres remain on the ground. **This is an acceptable way to tow your vehicle.**

» Emergency Towing

2.0 L engine models

NOTICE

Improper towing such as towing behind a motorhome or other motor vehicle can damage the front bumper.

All models

NOTICE

Trying to lift or tow your vehicle by the bumpers will cause serious damage. The bumpers are not designed to support the vehicle's weight.

Never tow your vehicle with just a rope or chain. It is very dangerous since ropes or chains may shift from side to side or break.

Continued

Except 2.0 L engine models

■ If your vehicle must be towed with the front wheels on the ground:

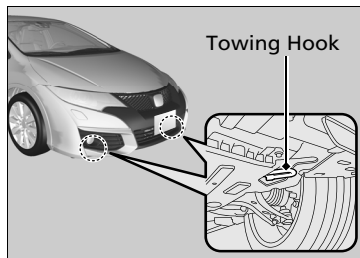

Automatic transmission models

1. Check the transmission fluid level.
➔ **Automatic Transmission Fluid** P. 508

All models

2. Hook the towing device to the towing hook.
3. Start the engine.
▶ If it is difficult to turn on the engine, put the ignition switch in ACCESSORY **I** or ON **II***1.

Automatic transmission models

4. Depress the brake pedal.
5. Shift to **D** and hold for five seconds, then to **N**.
6. Release the parking brake.

Manual transmission models

4. Shift to **N**.
5. Release the parking brake.

➤ If your vehicle must be towed with the front wheels on the ground:

If you cannot follow the exact procedure, do not tow your vehicle with the front wheels on the ground.

If you cannot turn on the engine, you may experience the following while your vehicle is being towed.

- Braking may become difficult since the brake system's power assist is disabled.
- Steering wheel becomes heavy as the power steering system is disabled.

Manual transmission models

- Turning the ignition switch to LOCK **0***1 locks the steering wheel.

Going down a long slope heats up the brakes. This may prevent the brakes from working properly. If your vehicle needs to be towed on an incline, call a professional towing service.

With the front wheels on the ground, it is best to tow the vehicle no farther than 80 km (50 miles), and keep the speed below 55 km/h (34 mph).

*1: Models with the keyless access system have an **ENGINE START/STOP** button instead of an ignition switch.

When You Cannot Open the Tailgate

When You Cannot Open the Tailgate

If you cannot open the tailgate, use the following procedure.

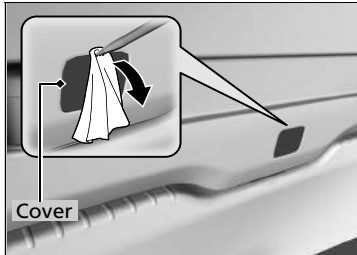

1. Use a flat-tip screwdriver and remove the cover on the back of the tailgate.

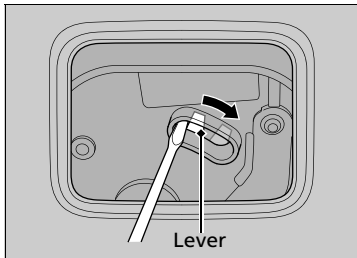

2. To open the tailgate, push the tailgate while pushing down the lever with the flat-tip screw driver.

When You Cannot Open the Tailgate

What to do following up

After taking these steps, contact a dealer to have your vehicle checked.

When you open the tailgate from inside, make sure there is enough space around the tailgate, and it does not hit anyone or any object.

Diesel models

Refueling From a Portable Fuel Container

If you have run out of fuel and need to refuel your vehicle from a portable fuel container, use the funnel provided with your vehicle.

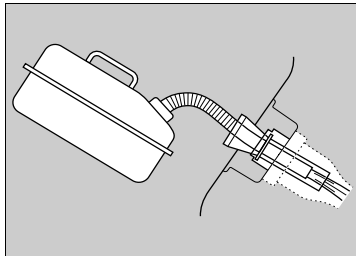
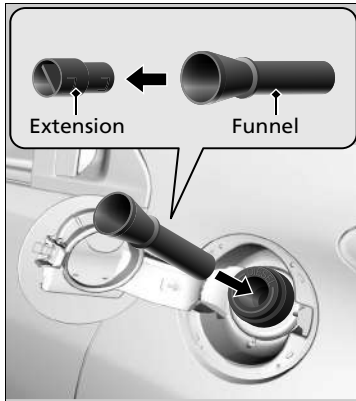

1. Turn off the engine.
2. Pull on the fuel fill door release handle under the driver's side lower outside corner of the dashboard.
 - ▶ The fuel fill door opens.
3. Take the funnel out of the compartment located on the left side in the luggage area.
 - ▶ **Types of Tools** P. 556
4. Remove the extension from the funnel.
5. Insert the funnel into the filler neck fully and slowly.
6. Fill the tank with fuel from the portable fuel container.
 - ▶ Pour fuel carefully so you do not spill any.
7. Remove the funnel from the filler neck.
 - ▶ Wipe up any fuel from the funnel before storing it.
8. Shut the fuel fill door by hand.

▶ Refueling From a Portable Fuel Container

WARNING

Fuel is highly flammable and explosive. You can be burned or seriously injured when handling fuel.

- Stop the engine, and keep heat, sparks, and flame away.
- Handle fuel only outdoors.
- Wipe up spills immediately.

NOTICE

Do not insert the nozzle of a portable fuel container or any funnel other than the one provided with your vehicle. Doing so can damage the fuel system.

Do not try to pry open or push open the sealed fuel tank with foreign objects. This can damage the fuel system and its seal.

Make sure the fuel in the portable fuel container is diesel fuel before you refuel.

Priming the Fuel System

Diesel models with fuel system primer

How to Bleed Air from the Fuel System

If the fuel tank has been run dry, air may enter the fuel system. This prevents the engine from restarting even after you refuel the vehicle.

Bleed the air from the fuel system as follows:

1. Pour at least 5 litres of fuel in the fuel tank.

➤ **Refueling From a Portable Fuel Container** P. 602

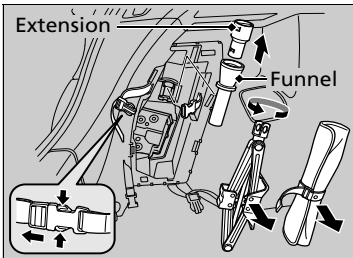
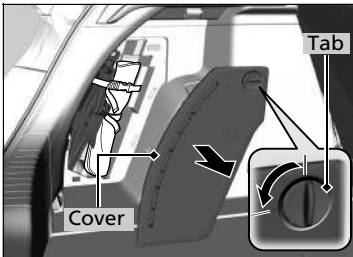

2. Open the tailgate.
3. Turn and pull the tab to open the compartment cover located on the left side of the luggage area.

4. Take the funnel out of the compartment.
5. Remove the extension from the funnel.

How to Bleed Air from the Fuel System

If you are not sure how to bleed the air, consult a dealer.

Continued



6. Open the left side of the front door.
7. Move the seat to the rear.

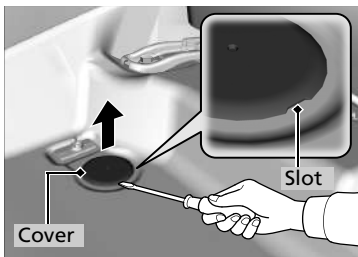

8. Open the cover in the floor.

Models with floor mat

- ▶ Remove the floor mat.
 - **Floor Mats*** P. 550
- ▶ You can open the cover by prying it off with a flat-tip screwdriver.

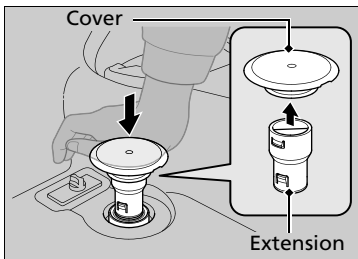

9. Put the cover on the extension.
10. Place the extension on the rod, which is located in the floor where the cover has been removed.
11. Using your hand, apply pressure on the cover to push down the rod.
 - ▶ Repeatedly press the cover until it becomes hard to press it down.

▶ How to Bleed Air from the Fuel System

When reinstalling the floor mat, turn the knobs to the lock position.

If the engine fails to restart after priming the fuel system, there is a problem in the fuel system. Have your vehicle inspected by a dealer.

12. Start the engine.
 - ▶ **Starting the Engine** P. 382, 385
 - ▶ Do not hold the ignition switch for more than 10 seconds at a time. This will damage the fuel pump and the engine starter.
 - ▶ If the engine does not start, go back to step 10.
13. Depress the accelerator pedal slightly and hold it at approximately 1,500 rpm for about 30 seconds.
 - ▶ Air bleeding of the fuel system is complete.
14. Turn off the engine, then restart it again. Repeat this at least three times at intervals of approximately 45 seconds.
 - ▶ The malfunction indicator lamp or **PGM-FI** goes off.

Information

This chapter includes your vehicle's specifications, locations of identification numbers, and other information required by regulation.

Specifications	608
Identification Numbers	
Vehicle Identification Number (VIN), Engine Number and Transmission Number..	619
Devices that Emit Radio Waves*	622
EC Declaration of Conformity Content Outline*	624

* Not available on all models

Petrol models (1.4 L engine models)

■ Vehicle Specifications

Model	CIVIC
Curb Weight	1,184-1,275 kg (2,610-2,811 lbs)
Maximum Permissible Weight	1,680 kg (3,704 lbs)
Maximum Permissible Axle Weight	Front 900 kg (1,984 lbs) Rear 820 kg (1,808 lbs)

■ Engine Specifications

Type	Water cooled 4-stroke SOHC i-VTEC in line, 4-cylinder petrol engine
Bore x Stroke	73.0 x 80.0 mm (2.87 x 3.15 in)
Displacement	1,339 cm ³ (82 cu-in)
Compression Ratio	10.5 : 1
Spark Plugs	NGK IZFR6K13 DENSO SKJ20DR-M13

■ Fuel

Fuel:	Premium unleaded petrol, Research octane number of 95 or higher
Type	
Fuel Tank Capacity	50 ℓ

■ Battery

Capacity/Type	48AH(5)/60AH(20)
---------------	------------------

■ Washer Fluid

Tank Capacity	2.0 ℓ* ¹ 2.5 ℓ* ^{2,3} 4.5 ℓ* ⁴
---------------	---

*1: Vehicle without rear wiper

*2: Vehicle with rear wiper

*3: Vehicle without headlight washer

*4: Vehicle with headlight washer

■ Light Bulbs

Headlights (Low Beam)	55 W (H7)
Headlights (High Beam)	55 W (H7)
Front Fog Lights* ¹	55 W (H11)
Front Turn Signal Lights	21 W (Amber)
Daytime Running Lights	LED
Position Lights	LED
Side Turn Signal Lights (on Door Mirrors)	LED
Brake/Tail-lights	LED
Rear Turn Signal Lights	16 W (Amber)
Back-Up Lights	16 W
Rear Fog Light	21 W
High-Mount Brake Light	LED
Rear Licence Plate Lights	5 W
Interior Lights	
Map Lights* ¹	8 W
Ceiling Light	8 W
Vanity Mirror Lights* ¹	2 W
Luggage Area Light	5 W

*1: Not available on all models

■ Brake/Clutch Fluid

Specified	Brake Fluid with DOT 3 or DOT 4
-----------	---------------------------------

■ Manual Transmission Fluid

Specified	Honda Manual Transmission Fluid	
Capacity	Change	1.4 ℓ

■ Engine Oil

Recommended	European models	
	Genuine Honda Motor Oil ^{*1} ACEA A3/B3, A5/B5 or higher grade 0W-20	
	European models without service reminder system	
	Genuine Honda Motor Oil ^{*1} ACEA A1/B1, A3/B3, A5/B5 or higher grade 0W-20	
Capacity	Except European models	
	Genuine Honda Motor Oil ^{*2} API service SM or higher grade fuel- efficient oil 0W-20, 0W-30, 5W-30, 10W-30	
	Change	3.4 ℓ
	Change including filter	3.6 ℓ

*1: If you use 0W-20, you should use "Honda Engine Oil Type 2.0".
*2: If you use 0W-20, you should use "Honda Engine Oil Type 2.0"
or genuine oil which has API service grade mark.

■ Engine Coolant

Specified	Honda All Season Antifreeze/Coolant Type2	
Ratio	50/50 with distilled water	
Capacity	4.72 ℓ (change including the remaining 0.46 ℓ in the reserve tank) ^{*1, *3}	
	4.61 ℓ (change including the remaining 0.46 ℓ in the reserve tank) ^{*1, *4}	
	4.61 ℓ (change including the remaining 0.46 ℓ in the reserve tank) ^{*2, *3}	
	4.49 ℓ (change including the remaining 0.46 ℓ in the reserve tank) ^{*2, *4}	
	0.46 ℓ in the reserve tank) ^{*2, *4}	

*1: Left-hand drive type
*2: Right-hand drive type
*3: Vehicle with auxiliary electric water pump
*4: Vehicle without auxiliary electric water pump

■ Tyre

Regular	Size	195/65R15 91T 205/55R16 91V 225/45R17 91W
	Pressure	See the label on driver's doorjamb
	Compact Spare ^{*1}	Size T135/80D16 101M Pressure kPa (bar [psil]) 420 (4.2 [60])
Wheel Size	Regular	15 x 6J ^{*2} 16 x 6 1/2J ^{*3} 17 x 7J ^{*4}
	Compact Spare ^{*1}	16 x 4T

*1: Vehicle with compact spare tyre
*2: Vehicle with 195/65R15 tyres
*3: Vehicle with 205/55R16 tyres
*4: Vehicle with 225/45R17 tyres

■ Honda TRK Air Compressor^{*1}

A weighted emission sound pressure level	80 ± 5 dB (A)
A weighted sound power level	91.5 ± 5 dB (A)

*1: Vehicle with tyre repair kit

■ Brake

Type	Power assisted
Front	Ventilated disc
Rear	Solid disc
Parking	Mechanical

■ Air Conditioning

LHD models	
Refrigerant Type	HFO-1234yf (R-1234yf)
Charge Quantity	360 – 400 g
RHD models	
Refrigerant Type	HFO-1234yf (R-1234yf)
Charge Quantity	400 – 440 g

■ Vehicle Dimensions

Length		4,370 mm (172.1 in)
Width		1,770 mm (69.7 in) ^{*1}
		1,795 mm (70.7 in) ^{*2}
Height	Antenna base	1,440 mm (56.7 in) ^{*1}
		1,470 mm (57.9 in) ^{*2}
Wheelbase		2,595 mm (102.2 in)
Track	Front	1,530 mm (60.2 in) ^{*3}
	Rear	1,540 mm (60.6 in) ^{*4}

- *1: Vehicle with removable antenna
- *2: Vehicle without removable antenna
- *3: Vehicle with 225/45R17 tyres
- *4: Vehicle without 225/45R17 tyres

■ The mounting point/rear over hang of coupling device^{*1}

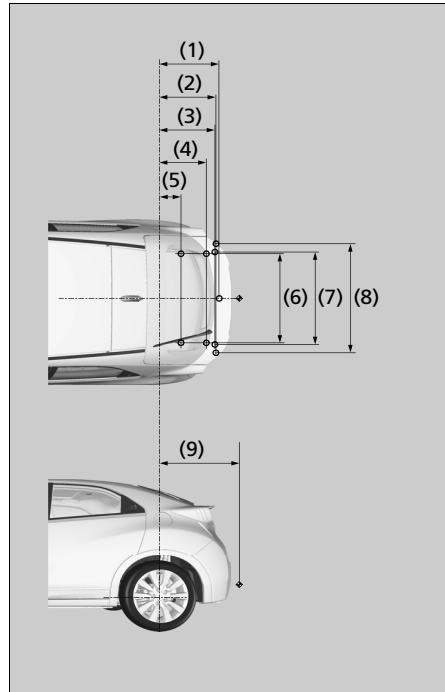

NOTE:

1. ○ marks show towbar fixing points.
2. ◄ mark shows towbar coupling point.

No.	Dimensions
(1)	640 mm (25.2 in)
(2)	606 mm (23.9 in)
(3)	605 mm (23.8 in)
(4)	521 mm (20.5 in)
(5)	308 mm (12.1 in)
(6)	1,014 mm (39.9 in)
(7)	1,025 mm (40.4 in)
(8)	1,125 mm (44.3 in)
(9)	909 mm (35.8 in)

*1: Except "S" grade models

■ Max. Towing Weight^{*1}

Trailer with brakes	1,200 kg (2,646 lbs)
Trailer without brakes	500 kg (1,102 lbs)
The maximum permissible vertical load on the coupling device	75 kg (165 lbs)

*1: Except "S" grade models

Petrol models (1.8 L engine models)

Vehicle Specifications

Model		CIVIC
Curb Weight	MT	1,207-1,295 kg (2,661-2,855 lbs) ^{*1} 1,271-1,341 kg (2,802-2,956 lbs) ^{*2}
	AT	1,242-1,261 kg (2,738-2,780 lbs) ^{*3} 1,297-1,372 kg (2,859-3,025 lbs) ^{*4}
Maximum Permissible Weight	MT	1,720 kg (3,792 lbs) ^{*1} 1,750 kg (3,858 lbs) ^{*2}
	AT	1,720 kg (3,792 lbs) ^{*3} 1,790 kg (3,946 lbs) ^{*4}
Maximum Permissible Axle Weight	MT	Front 920 kg (2,028 lbs) ^{*1} 950 kg (2,094 lbs) ^{*2}
	AT	Front 930 kg (2,050 lbs) ^{*3} 990 kg (2,183 lbs) ^{*4}
		Rear 820 kg (1,808 lbs) ^{*1} 830 kg (1,830 lbs) ^{*2}
		Rear 830 kg (1,830 lbs)

*1: Vehicle without rearview camera

*2: Vehicle with rearview camera

*3: Vehicle with 195/65R15 tyres

*4: Vehicle without 195/65R15 tyres

Engine Specifications

Type	Water cooled 4-stroke SOHC i-VTEC in line, 4-cylinder petrol engine
Bore x Stroke	81.0 x 87.3 mm (3.19 x 3.44 in)
Displacement	1,798 cm ³ (110 cu-in)
Compression Ratio	10.6 : 1
Spark Plugs	NGK DILZKR7B11GS
	DENSO DXU22HCR-D11S

Fuel

Fuel:	Premium unleaded petrol, Research octane number of 95 or higher
Fuel Tank Capacity	50 ℓ

Battery

Capacity/Type	48AH(5)/60AH(20)
---------------	------------------

Washer Fluid

Tank Capacity	2.0 ℓ ^{*1}
	2.5 ℓ ^{*2, *3}
	4.5 ℓ ^{*4}

*1: Vehicle without rear wiper

*2: Vehicle with rear wiper

*3: Vehicle without headlight washer

*4: Vehicle with headlight washer

Light Bulbs

Headlights (Low Beam)	55 W (H7) ^{*1} LED ^{*2}	
Headlights (High Beam)	55 W (H7)	
Front Fog Lights ^{*3}	55 W (H11)	
Front Turn Signal Lights	21 W (Amber)	
Daytime Running Lights	LED	
Position Lights	LED	
Side Turn Signal Lights (on Door Mirrors)	LED	
Brake/Tail-lights	LED	
Rear Turn Signal Lights	16 W (Amber)	
Back-Up Lights	16 W	
Rear Fog Light	21 W	
High-Mount Brake Light	LED	
Rear Licence Plate Lights	5 W	
Interior Lights	Map Lights ^{*3}	8 W
	Ceiling Light	8 W
	Vanity Mirror Lights ^{*3}	2 W
	Luggage Area Light	5 W
	Glove Box Light ^{*3}	3.4 W

*1: Vehicle with halogen headlights

*2: Vehicle with LED headlights

*3: Not available on all models

■ Brake/Clutch Fluid

Specified	Brake Fluid with DOT 3 or DOT 4
-----------	---------------------------------

■ Automatic Transmission Fluid

Specified	Honda ATF DW-1 (automatic transmission fluid)
Capacity	Change 2.4 ℓ

■ Manual Transmission Fluid

Specified	Honda Manual Transmission Fluid
Capacity	Change 1.4 ℓ

■ Engine Oil

Recommended	European models	
	Genuine Honda Motor Oil ^{*1} ACEA A3/B3, A5/B5 or higher grade 0W-20	
	European models without service reminder system	
Capacity	Genuine Honda Motor Oil ^{*1} ACEA A1/B1, A3/B3, A5/B5 or higher grade 0W-20	
	Except European models	
	Genuine Honda Motor Oil ^{*2} API service SM or higher grade fuel- efficient oil 0W-20, 0W-30, 5W-30, 10W-30	
	Change	3.5 ℓ
	Change including filter	3.7 ℓ

*1: If you use 0W-20, you should use "Honda Engine Oil Type 2.0".

*2: If you use 0W-20, you should use "Honda Engine Oil Type 2.0" or genuine oil which has API service grade mark.

■ Engine Coolant

Specified	Honda All Season Antifreeze/Coolant Type2
Ratio	50/50 with distilled water
Capacity	5.57 ℓ (change including the remaining 0.475 ℓ in the reserve tank) ^{*1, *3, *6}
	5.66 ℓ (change including the remaining 0.475 ℓ in the reserve tank) ^{*1, *4, *5}
	5.57 ℓ (change including the remaining 0.475 ℓ in the reserve tank) ^{*1, *4, *6}
	5.62 ℓ (change including the remaining 0.475 ℓ in the reserve tank) ^{*2, *3, *6}
	5.49 ℓ (change including the remaining 0.475 ℓ in the reserve tank) ^{*2, *4, *5}
	5.62 ℓ (change including the remaining 0.475 ℓ in the reserve tank) ^{*2, *4, *5}
	5.62 ℓ (change including the remaining 0.475 ℓ in the reserve tank) ^{*2, *4, *6}

*1: Left-hand drive type

*2: Right-hand drive type

*3: Automatic transmission models

*4: Manual transmission models

*5: Vehicle with auxiliary electric water pump

*6: Vehicle without auxiliary electric water pump

■ Tyre

Regular	Size	195/65R15 91T 205/55R16 91V 225/45R17 91W
	Pressure	See the label on driver's doorjamb
	Compact Spare ^{*1}	Size T135/80D16 101M Pressure 420 (4.2 [60]) kPa (bar [psi])
Wheel Size	Regular	15 x 6J ^{*2} 16 x 6 1/2J ^{*3} 17 x 7J ^{*4}
	Compact Spare ^{*1}	16 x 4T

*1: Vehicle with compact spare tyre

*2: Vehicle with 195/65R15 tyres

*3: Vehicle with 205/55R16 tyres

*4: Vehicle with 225/45R17 tyres

■ Honda TRK Air Compressor^{*1}

A weighted emission sound pressure level	80 ± 5 dB (A)
A weighted sound power level	91.5 ± 5 dB (A)

*1: Vehicle with tyre repair kit

■ Brake

Type	Power assisted
Front	Ventilated disc
Rear	Solid disc
Parking	Mechanical

■ Air Conditioning

LHD models	
Refrigerant Type	HFO-1234yf (R-1234yf)
Charge Quantity	360 – 400 g
RHD models	
Refrigerant Type	HFO-1234yf (R-1234yf)
Charge Quantity	400 – 440 g

■ Vehicle Dimensions

Length	4,370 mm (172.1 in)
Width	1,770 mm (69.7 in) ^{*1}
	1,795 mm (70.7 in) ^{*2}
Height	Antenna base 1,440 mm (56.7 in) ^{*1}
	1,470 mm (57.9 in) ^{*2}
Wheelbase	2,595 mm (102.2 in)
Track	Front 1,530 mm (60.2 in) ^{*3}
	Rear 1,530 mm (60.2 in) ^{*3}
	1,540 mm (60.6 in) ^{*4}

- *1: Vehicle with removable antenna
- *2: Vehicle without removable antenna
- *3: Vehicle with 225/45R17 tyres
- *4: Vehicle without 225/45R17 tyres

■ The mounting point/rear over hang of coupling device^{*1}

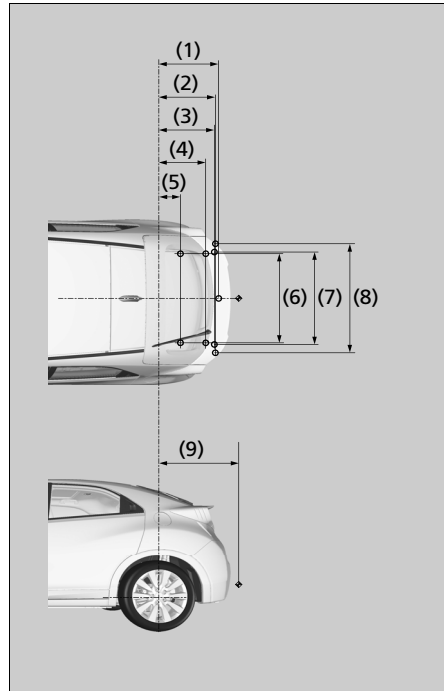

NOTE:

- 1. ○ marks show towbar fixing points.
- 2. ◀ mark shows towbar coupling point.

No.	Dimensions
(1)	640 mm (25.2 in)
(2)	606 mm (23.9 in)
(3)	605 mm (23.8 in)
(4)	521 mm (20.5 in)
(5)	308 mm (12.1 in)
(6)	1,014 mm (39.9 in)
(7)	1,025 mm (40.4 in)
(8)	1,125 mm (44.3 in)
(9)	909 mm (35.8 in)

*1: Except "S" grade models

■ Max. Towing Weight^{*1}

Trailer with brakes	Manual Transmission Models	1,400 kg (3,086 lbs)
	Automatic Transmission Models	1,000 kg (2,205 lbs)
Trailer without brakes	Manual Transmission Models	500 kg (1,102 lbs)
	Automatic Transmission Models	500 kg (1,102 lbs)
The maximum permissible vertical load on the coupling device		75 kg (165 lbs)

*1: Except "S" grade models

Petrol models (2.0 L engine models)

■ Vehicle Specifications

Model	CIVIC	
Curb Weight	1,382-1,397 kg (3,047-3,080 lbs)	
Maximum Permissible Weight	1,700 kg (3,748 lbs)	
Maximum Permissible Axle Weight	Front	1,010 kg (2,227 lbs)
	Rear	750 kg (1,653 lbs)

■ Engine Specifications

Type	Water cooled 4-stroke DOHC i-VTEC in line, 4-cylinder petrol engine	
Bore x Stroke	86.0 x 85.9mm (3.39 x 3.38 in)	
Displacement	1,996 cm ³ (122 cu-in)	
Compression Ratio	9.8 : 1	
Spark Plugs	NGK	ILZKAR8H8S

■ Fuel

Fuel:	Premium unleaded petrol, Research octane	
Type	number of 95 or higher	
Fuel Tank Capacity	50 ℓ	

■ Battery

Capacity/Type	60AH(20)/L2
---------------	-------------

Idle Stop:
The battery installed in this vehicle is specifically designed for a model with Auto Idle Stop. If you need to replace the battery, make sure to select the specified type. Ask a dealer for more details.

■ Washer Fluid

Tank Capacity	2.0 ℓ
---------------	-------

■ Light Bulbs

Headlights (Low Beam)	LED
Headlights (High Beam)	55 W (H7)
Front Fog Lights	55 W (H11)
Front Turn Signal Lights	21 W (Amber)
Daytime Running Lights	LED
Position Lights	LED
Side Turn Signal Lights (on Door Mirrors)	LED
Brake/Tail-lights	LED
Rear Turn Signal Lights	16 W (Amber)
Back-Up Lights	16 W
Rear Fog Light	21 W
High-Mount Brake Light	LED
Rear Licence Plate Lights	5 W
Interior Lights	
Map Lights	8 W
Ceiling Light	8 W
Vanity Mirror Lights	2 W
Luggage Area Light	5 W

■ Brake/Clutch Fluid

Specified	Brake Fluid with DOT 3 or DOT 4
-----------	---------------------------------

■ Manual Transmission Fluid

Specified	Honda Manual Transmission Fluid	
Capacity	Change	2.2 ℓ

■ Engine Oil

Recommended	European models	
	Genuine Honda Motor Oil ^{*1} ACEA A3/B3, A5/B5 or higher grade 0W-20	
	Except European models	
	Genuine Honda Motor Oil ^{*2} API service SM or higher grade fuel- efficient oil 0W-20, 0W-30, 5W-30, 10W-30	
Capacity	Change	5.0 ℓ
	Change including filter	5.4 ℓ

*1: If you use 0W-20, you should use "Honda Engine Oil Type 2.0".

*2: If you use 0W-20, you should use "Honda Engine Oil Type 2.0" or genuine oil which has API service grade mark.

■ Engine Coolant

Specified	Honda All Season Antifreeze/Coolant Type2	
Ratio	50/50 with distilled water	
Capacity	6.69 ℓ (change including the remaining 0.475 ℓ in the reserve tank) ^{*1}	
	6.52 ℓ (change including the remaining 0.475 ℓ in the reserve tank) ^{*2}	

*1: Left-hand drive type

*2: Right-hand drive type

■ Tyre

	Size	235/35ZR19 91Y
Regular	Pressure	See the label on driver's doorjamb
Wheel Size	Regular	19 x 8 1/2J

■ Honda TRK Air Compressor

A weighted emission sound pressure level	80 ± 5 dB (A)
A weighted sound power level	91.5 ± 5 dB (A)

■ Air Conditioning

LHD models	
Refrigerant Type	HFO-1234yf (R-1234yf)
Charge Quantity	360 – 400 g
RHD models	
Refrigerant Type	HFO-1234yf (R-1234yf)
Charge Quantity	400 – 440 g

■ Vehicle Dimensions

Length	4,390 mm (172.8 in)	
Width	1,878 mm (73.9 in)	
Height	Shark fin antenna	1,459 mm (57.4 in)
Wheelbase	2,594mm (102.1 in)	
Track	Front	1,605 mm (63.2 in) ^{*1}
		1,615 mm (63.6 in) ^{*2}
	Rear	1,528 mm (60.2 in) ^{*1}
		1,538 mm (60.6 in) ^{*2}

*1: Offset 60 mm (2.4 in)

*2: Offset 55 mm (2.2 in)

Diesel models

Vehicle Specifications

Model	CIVIC
Curb Weight	1,307-1,425 kg (2,881-3,142 lbs)
Maximum Permissible Weight	1,870 kg (4,123 lbs)
Maximum Permissible Axle Weight	Front 1,050 kg (2,315 lbs) Rear 845 kg (1,863 lbs)

Engine Specifications

Type	Water cooled 4-stroke DOHC i-DTEC diesel engine with turbo charger, intercooler
Bore x Stroke	76.0 x 88.0 mm (2.99 x 3.46 in)
Displacement	1,597 cm ³ (97 cu-in)
Compression Ratio	16.0 : 1

Fuel

Fuel Type	EN590 standard diesel fuel
Fuel Tank Capacity	50 ℓ

Battery

Capacity/Type	70AH(20)/L3
---------------	-------------

Idle Stop:

The battery installed in this vehicle is specifically designed for a model with Auto Idle Stop. If you need to replace the battery, make sure to select the specified type. Ask a dealer for more details.

Washer Fluid

Tank Capacity	2.0 ℓ ^{*1}
	2.5 ℓ ^{*2, *3}
	4.5 ℓ ^{*4}

- *1: Vehicle without rear wiper
- *2: Vehicle with rear wiper
- *3: Vehicle without headlight washer
- *4: Vehicle with headlight washer

Light Bulbs

Headlights (Low Beam)	55 W (H7) ^{*1} LED ^{*2}
Headlights (High Beam)	55 W (H7)
Front Fog Lights ^{*3}	55 W (H11)
Front Turn Signal Lights	21 W (Amber)
Daytime Running Lights	LED
Position Lights	LED
Side Turn Signal Lights (on Door Mirrors)	LED
Brake/Tail-lights	LED
Rear Turn Signal Lights	16 W (Amber)
Back-Up Lights	16 W
Rear Fog Light	21 W
High-Mount Brake Light	LED
Rear Licence Plate Lights	5 W
Interior Lights	
Map Lights ^{*3}	8 W
Ceiling Light	8 W
Vanity Mirror Lights ^{*3}	2 W
Luggage Area Light	5 W
Glove Box Light ^{*3}	3.4 W

- *1: Vehicle with halogen headlights
- *2: Vehicle with LED headlights
- *3: Not available on all models

■ Brake/Clutch Fluid

Specified	Brake Fluid with DOT 3 or DOT 4
-----------	---------------------------------

■ Manual Transmission Fluid

Specified	Honda Manual Transmission Fluid	
Capacity	Change	1.9 ℓ

■ Engine Oil

Recommended	European models	
	Honda Diesel Oil #1.0 ACEA C2/C3 0W-30	
Capacity	Except European models	
	Honda Diesel Oil #1.0 ACEA C2/C3 0W-30, 0W-40, 5W-30, 5W-40, 10W-30, 10W-40	
	Change	4.3 ℓ
	Change including filter	4.7 ℓ

■ Engine Coolant

Specified	Honda All Season Antifreeze/Coolant Type2	
Ratio	50/50 with distilled water	
Capacity	5.66 ℓ (change including the remaining 0.56 ℓ in the expansion tank)	

■ Tyre

Regular	Size	205/55R16 91V 225/45R17 91W
	Pressure	See the label on driver's doorjamb
Compact Spare*1	Size	T135/80D16 101M
	Pressure kPa (bar [psij])	420 (4.2 [60])
Wheel Size	Regular	16 x 6 1/2J*2 17 x 7J*3
	Compact Spare*1	16 x 4T

*1: Vehicle with compact spare tyre

*2: Vehicle with 205/55R16 tyres

*3: Vehicle with 225/45R17 tyres

■ Honda TRK Air Compressor*1

A weighted emission sound pressure level	80 ± 5 dB (A)
A weighted sound power level	91.5 ± 5 dB (A)

*1: Vehicle with compact spare tyre

■ Brake

Type	Power assisted
Front	Ventilated disc
Rear	Solid disc
Parking	Mechanical

■ Air Conditioning

LHD models	
Refrigerant Type	HFO-1234yf (R-1234yf)
Charge Quantity	360 – 400 g
RHD models	
Refrigerant Type	HFO-1234yf (R-1234yf)
Charge Quantity	400 – 440 g

■ Vehicle Dimensions

Length		4,370 mm (172.1 in)
Width		1,770 mm (69.7 in) ^{*1}
		1,795 mm (70.7 in) ^{*2}
Height	Antenna base	1,440 mm (56.7 in) ^{*1}
		1,470 mm (57.9 in) ^{*2}
Wheelbase		2,595 mm (102.2 in)
Track	Front	1,530 mm (60.2 in) ^{*3}
	Rear	1,540 mm (60.6 in) ^{*4}

- *1: Vehicle with removable antenna
- *2: Vehicle without removable antenna
- *3: Vehicle with 225/45R17 tyres
- *4: Vehicle without 225/45R17 tyres

■ The mounting point/rear over hang of coupling device

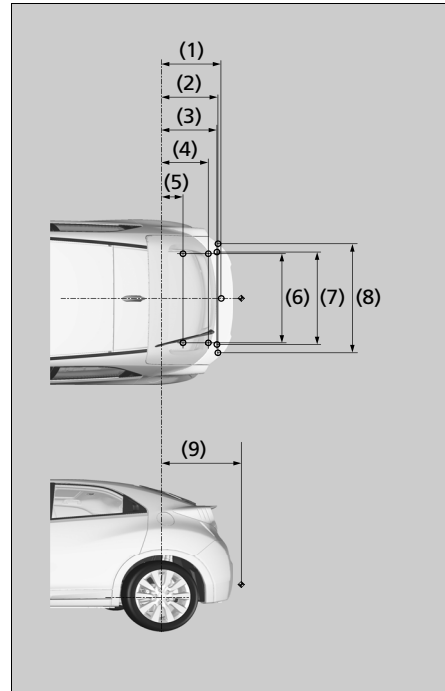

NOTE:

1. ○ marks show towbar fixing points.
2. ◀ mark shows towbar coupling point.

No.	Dimensions
(1)	640 mm (25.2 in)
(2)	606 mm (23.9 in)
(3)	605 mm (23.8 in)
(4)	521 mm (20.5 in)
(5)	308 mm (12.1 in)
(6)	1,014 mm (39.9 in)
(7)	1,025 mm (40.4 in)
(8)	1,125 mm (44.3 in)
(9)	909 mm (35.8 in)

■ Max. Towing Weight

Trailer with brakes	1,400 kg (3,086 lbs)
Trailer without brakes	500 kg (1,102 lbs)
The maximum permissible vertical load on the coupling device	75 kg (165 lbs)

Vehicle Identification Number (VIN), Engine Number and Transmission Number

Your vehicle has a 17-digit vehicle identification number (VIN) used to register your vehicle for warranty purposes, and for licensing and insuring your vehicle. The locations of your vehicle's VIN, engine number and transmission number are shown as follows.

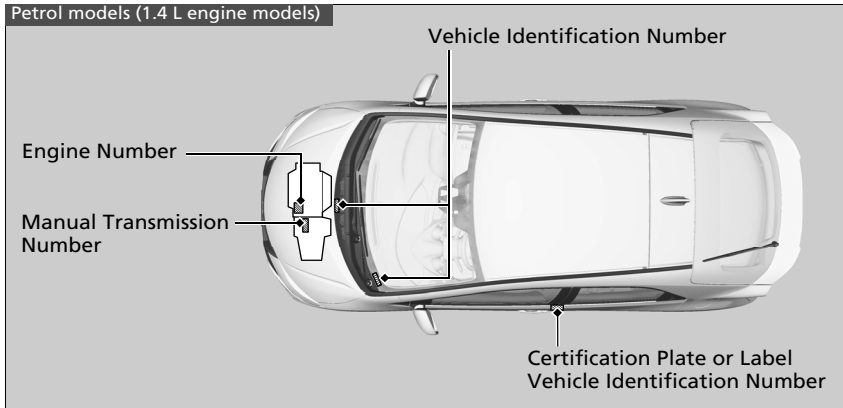

Petrol models (1.8 L engine models)

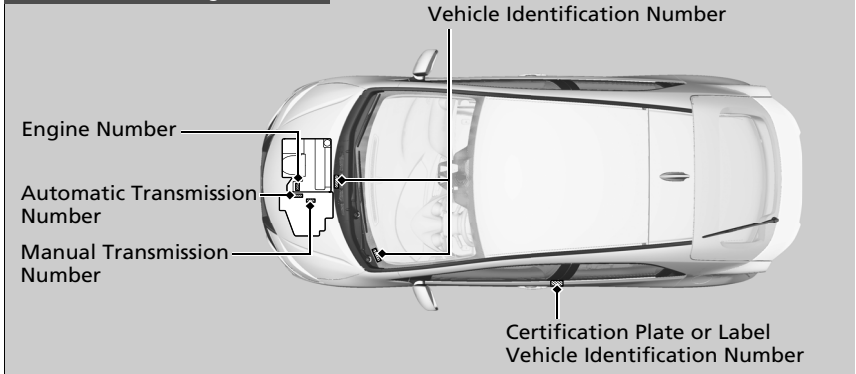

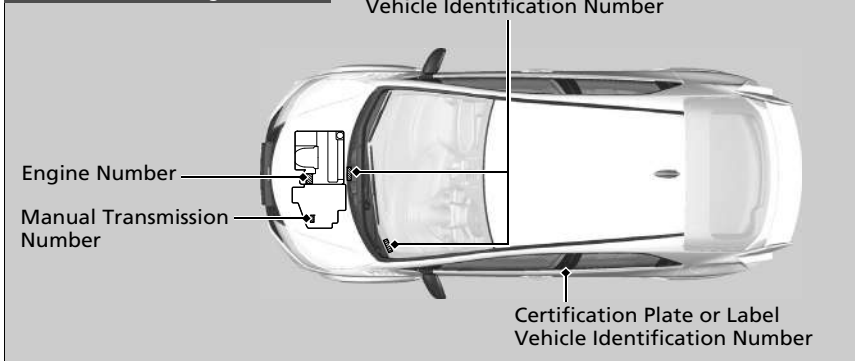

Petrol models (2.0 L engine models)

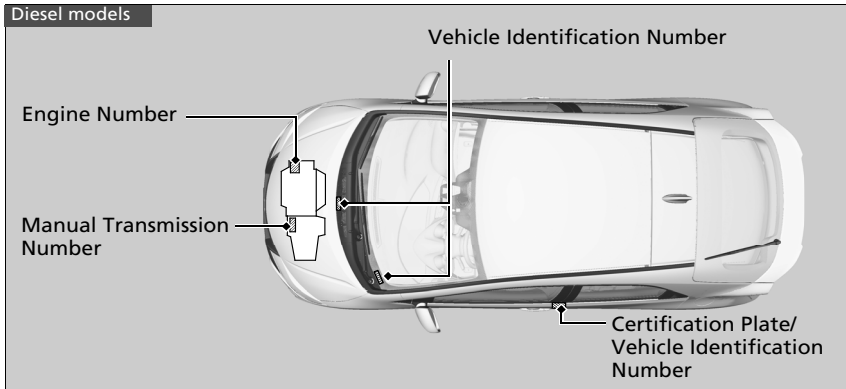



Devices that Emit Radio Waves*

The following products and systems on your vehicle emit radio waves when in operation.

Remote Transmitter*	Immobilizer System	Keyless Access System*
		

» Devices that Emit Radio Waves*

European models

Models with remote transmitter

Models with keyless access system

EC Directives

Each of the items in the table complies with the essential requirements and other relevant provisions of R & TTE (Radio equipment and Telecommunications Terminal Equipment and the mutual recognition of their conformity) Directive 1999/5/EC.

See the following URLs for Declaration of conformity:
<http://www.techinfo.honda-eu.com>

Hands-Free Telephone
System*



▶▶▶ Devices that Emit Radio Waves*

European models

Models with Hands-Free Telephone System

EC Directives

Each of the items in the table complies with the essential requirements and other relevant provisions of R & TTE (Radio equipment and Telecommunications Terminal Equipment and the mutual recognition of their conformity) Directive 1999/5/EC.

See the following URLs for Declaration of conformity:
<http://www.techinfo.honda-eu.com>

* Not available on all models

EC Declaration of Conformity



1. The undersigned, Mr. Ryoichi Hiraki, representing the manufacturers, herewith declares that the machinery described below fulfils all the relevant provisions of:

- The EC-directive 2006/42/EC on machinery

2. Description of the machinery

a) Generic denomination: Pantograph jack
 b) Function: lifting motor vehicle

c) Model	d) Type
SNB	Honda Type-A
SJD	Honda Type-B
SZA	Honda Type-C
SAH	Honda Type-D
TP6	Honda Type-G
T5A	Honda Type-I
T2V	Honda Type-J

3. Manufacturer (1) : Honda Type-A/B/C/G/I
 RIKENKAKI CO., LTD.
 5-6-12 Chiyoda Sakado-shi,
 Saitama 350-0214
 JAPAN

4. Manufacturer (2) : Honda Type-D/J
 CHANGZHOU RIKENSEIKO MACHINERY CO., LTD.
 No. 1903 Zhongwu Ave. Zhonglou Changzhou,
 Jiangsu CHINA

5. Legal person authorised to compile the technical file :
 Honda Motor Europe Ltd Belgian Branch
 p/a Honda Motor Europe Ltd – Aalst Office
 Wijngaardveld 1 (Noord V)
 B-9300 Aalst (Belgium)

6. References to harmonized standards	7. Other standards or specifications
EN1494:2000+A1:2008	-

8. Done at: Saitama, Japan
 9. Date: 1 December, 2009

Ryoichi Hiraki
 Ryoichi Hiraki
 President of RIKENKAKI CO.,LTD.
 President of CHANGZHOU RIKENSEIKO
 MACHINERY CO.,LTD.

Note: This declaration becomes invalid, if technical or operational modifications are introduced without the manufacturers consent.

A

ABS (Anti-lock Brake System)	432
Accessories and Modifications	457
Accessory Power Sockets	208
Adding	
Coolant	503, 506
Engine Oil	502
Washer	511
Additives, Engine Oil	495, 497
Adjustable Speed Limiter	407
Adjustable Speed Limiter Indicator	94
Adjusting	
Front Seats	193
Head Restraints	196
Headlights	179, 514
Mirrors	190
Rear Seats	199
Steering Wheel	189
Temperature	124
Air Conditioning System (Climate Control System)	215
Changing the Mode	215, 218
Defrosting the Windscreen and Windows	216, 219
Dust and Pollen Filter	547
Recirculation/Fresh Air Mode	216, 219
Sensors	220
Synchronized Mode	217
Using Automatic Climate Control	215, 218
Air Pressure	609, 612, 615, 617

Airbags	48
After a Collision	51
Airbag Care	60
Event Data Recorder	29
Front Airbags (SRS)	50
Indicator	58, 88
Passenger Front Airbag Off Indicator	59
Sensors	48
Side Airbags	55
Side Curtain Airbags	57
AM/FM Radio	231, 277
Anti-lock Brake System (ABS)	432
Indicator	87
Armrest	201
Audio Remote Controls	227
Audio System	222
Adjusting the Sound	230, 274
Audio Antenna	226
Audio Remote Controls	227
Audio/Information Screen	259
Auxiliary Input Jack	224
Display Setup	275
Error Messages	304
General Information	308
HDMI™ Port	224
iPod and iPhone Model Compatibility	310
MP3/WMA/AAC	242, 250, 284, 290
Reactivating	225
Recommended CDs	308
Recommended Devices	310
Remote Controls	227

Security Code	225
Theft Protection	225
USB Flash Drives	310
USB Port	223
Auto Idle Stop	398
Auto Idle Stop Indicator	95
Auto Idle Stop System Indicator	95
Automatic Transmission	389
Creeping	389
Fluid	508
Kickdown	389
Operating the Shift Lever	21, 390, 391
Sequential Shift Mode	392
Shift Lever Does Not Move	582
Shifting	390
Auxiliary Input Jack	224
Average Fuel Economy	123
Average Speed	123

B

Battery	540
Charging System Indicator	84, 587
Jump Starting	578
Maintenance (Checking the Battery)	540
Maintenance (Replacing)	541
Belts (Seat)	36
Beverage Holders	205
Blind Spot Information System	425
Indicator	98
Bluetooth® Audio	254, 293

- Booster Seats (For Children)**..... 77
Brake System..... 430
 Anti-lock Brake System (ABS)..... 432
 Brake Assist System 433
 Fluid 510
 Foot Brake 431
 Indicator 588
 Indicator (Red) 82
 Parking Brake 430
Brake System Indicator (Amber)..... 82
Brightness Control (Instrument Panel) 187
Bulb Replacement..... 514
 Back-Up Lights..... 523
 Brake/Tail-lights 523
 Ceiling Light 527
 Daytime Running Lights 518
 Front Fog Lights..... 517
 Front Turn Signal Lights 519
 Glove Box Light 529
 Headlights 514
 High-Mount Brake Light 524
 Interior Lights 527
 Luggage Area Light 528
 Map Lights 527
 Position Lights 518
 Rear Fog Light 525
 Rear Licence Plate Lights 524
 Rear Turn Signal Lights 521
 Side Turn Signal Lights..... 520
 Vanity Mirror Lights 528
Bulb Specifications..... 608, 611, 614, 616
- C**
Carbon Monoxide Gas 79
Carrying Luggage..... 373, 375
CD Player..... 242, 284
Changing Bulbs 514
Charging System Indicator..... 84, 587
Child Restraint System 61
 Booster Seats 77
 Child Restraint System for Infants 64
 Child Restraint System for Small Children .. 66
 Installing a Child Restraint System with a
 Lap/Shoulder Seat Belt..... 73
 Larger Children 76
 Rear-Facing Child Restraint System 64
 Selecting a Child Restraint System 67
 Using Tether..... 75
Child Safety..... 61
 Childproof Door Locks..... 158
City-Brake Active System 434
 Indicator..... 99, 100
Cleaning the Exterior..... 551
Cleaning the Interior..... 549
Climate Control System..... 215
 Changing the Mode 215, 218
 Defrosting the Windscreen and
 Windows..... 216, 219
 Dust and Pollen Filter..... 547
 Recirculation/Fresh Air Mode 216, 219
 Sensors 220
 Synchronized Mode..... 217
 Using Automatic Climate Control 215, 218
- Clock** 148
Clutch Fluid 510
Coat Hook 209
Compact Spare
 Tyre 557, 609, 612, 615, 617
Console Compartment..... 204
Controls 147
Coolant (Engine)..... 503, 506
 Adding to the Expansion Tank 507
 Adding to the Radiator 505
 Adding to the Reserve Tank 504
 Overheating..... 583
Creeping (Automatic Transmission)..... 389
Cross Traffic Monitor 446
Cruise Control 404
 Indicator 94
Cruise Main Indicator 94
Cup Holders..... 205
Customized Features 131, 313
- D**
DAB..... 238, 281
Daytime Running Lights 182
Dead Battery 578
Defaulting All the Settings..... 328
Deflation Warning System 428
 Calibration 428
 Indicator 90
Defrosting the Windscreen and
 Windows..... 216, 219

Devices that Emit Radio Waves	622
Diesel	24, 453
Dimming	
Headlights	174
Dipstick (Engine Oil)	498
Directional Signals (Turn Signals)	174
Display/Information Button	120
Door Mirrors.....	191
Doors	149
Door and Tailgate Open Indicator	35, 89
Keys.....	149
Locking/Unlocking the Doors from the Inside	157
Locking/Unlocking the Doors from the Outside	152
Lockout prevention system.....	155
Driving	371
Automatic Transmission	389
Braking	430
Cruise Control	404
Shifting Gear	390, 395
Starting the Engine	382, 385
Dust and Pollen Filter	547

E

Eco Assist System.....	9
ECON Button	402
Elapsed Time	123
Electric Power Steering (EPS) System	
Indicator	90, 589

Emergency	599
Emergency Stop Signal	439
Engine	
Coolant	503, 506
Jump Starting	578
Oil	495, 497
Starting	382, 385
Switch Buzzer.....	170
Engine Coolant	503, 506
Adding to the Expansion Tank	507
Adding to the Radiator	505
Adding to the Reserve Tank.....	504
Overheating	583
Engine Oil	495, 497
Adding	502
Checking.....	498
Low Oil Level Indicator.....	591
Low Oil Pressure Indicator.....	83, 587
Recommended Engine Oil.....	495, 497
ENGINE START/STOP Button	171
EPS (Electric Power Steering)	
System	90, 589
Exhaust Hazard (Carbon Monoxide)	79
Exterior Care (Cleaning)	551
Exterior Mirrors	191

F

Features	221
Filter	
Dust and Pollen.....	547
Fuel.....	511
Flat Tyre	557
Floor Mats	550
Fluids	
Automatic Transmission	508
Brake/Clutch	510
Engine Coolant	503, 506
Manual Transmission.....	509
Windscreen Washer	511
Folding Down the Rear Seats	199
Folding the Rear Seat Up	200
Foot Brake	431
Forward Collision Warning	411
Indicator.....	96
Front Airbags (SRS)	50
Front Fog Light Indicator	92
Front Seats	
Adjusting	193
Fuel	452
Fuel Economy and CO ₂ Emissions	456
Gauge.....	119
Instant Fuel Economy	123
Low Fuel Indicator.....	86
Range	123
Recommendation	452, 453
Refueling.....	452
Fuel Economy and CO₂ Emissions	456

Fuel Fill Cap.....	23, 454
Fuel Fill Door.....	23, 24, 454, 455
Fuses.....	592
Inspecting and Changing.....	598
Locations.....	592, 594, 595, 597

G

Gauges.....	119
Gear Position Indicator.....	85
Gear Shift Lever Positions	
Automatic Transmission.....	390
Manual Transmission.....	395
Glass (care).....	552
Glove Box.....	204
Glow Plugs Indicator.....	87

H

Halogen Bulbs.....	514, 517
Hands-Free Telephone (HFT).....	329
Automatic Import of Mobile Phonebook and Call History.....	343
Automatic Transferring.....	341
Caller's ID Information.....	341
HFT Buttons.....	329
HFT Menus.....	331
HFT Status Display.....	330
Limitations for Manual Operation.....	330
Making a Call.....	347
Options During a Call.....	352

Phone Setup.....	335
Receiving a Call.....	351
Speed Dial.....	344
To Clear the System.....	342
To Create a Security PIN.....	340

Hands-Free Telephone (HFT) System..... 353

Automatic Import of Cellular Phonebook and Call History.....	364
HFT Buttons.....	353
HFT Menus.....	356
HFT Status Display.....	355
Limitations for Manual Operation.....	355
Making a Call.....	367
Menus.....	356
Options During a Call.....	370
Phone Setup.....	359
Receiving a Call.....	370
Ring Tone.....	363
Speed Dial.....	365

Hazard Warning Button..... 2, 3

HDMI™..... 295

Head Restraints..... 196

Headlights..... 174

Adjuster.....	179
Aiming.....	514
Automatic Operation.....	175
Dimming.....	174
High Beam Support.....	180
Operating.....	174

Heated Door Mirrors..... 188

Heaters (Seat)..... 214

HFT (Hands-Free Telephone)..... 329, 353

High Beam Indicator..... 91

High Beam Support Indicator..... 95

High Beam Support System..... 180

Honda TRK..... 565

I

Identification Numbers..... 619

Vehicle Identification..... 619

Ignition Switch..... 170

Illumination Control..... 187

Knob..... 187

Immobilizer System..... 162

Indicator..... 92

i-Multi-Information Display..... 120

Indicators..... 82

ABS (Anti-lock Brake System)..... 87

Adjustable Speed Limiter..... 94

Auto Idle Stop..... 95

Auto Idle Stop System..... 95

Blind Spot Information..... 98, 427

Brake System (Amber)..... 82

Charging System..... 84

City-Brake Active System (CTBA)..... 99, 100

Cruise Main..... 94, 404, 405

Door and Tailgate Open..... 89

ECON Mode..... 93

Electric Power Steering (EPS)..... 90

Forward Collision Warning..... 96

Front Fog Light..... 92

Gear Position	85	Interior Rearview Mirror	190	High Beam Indicator Light	91
Glow Plugs	87	iPod	246, 287	High Beam Support Indicator.....	95
Hazard Warning.....	91	J		Interior	202
High Beam	91	Jack (Wheel Nut Wrench)	561	Lights On Indicator	92
High Beam Support.....	95	Jump Starting	578	Turn Signals	174
Immobilizer System	92	K		Load Limits.....	375
Keyless Access System.....	93	Key Number Tag	151	Locking/Unlocking.....	149
Lane Departure Warning.....	97	Keys	149	Childproof Door Locks.....	158
Lights On	92	Lockout prevention.....	155	From Inside	157
Low Fuel	86	Number Tag	151	From Outside	152
Low Oil Pressure	83	Rear Door Won't Open	158	Keys.....	149
Low Tyre Pressure/Deflation Warning		Remote Transmitter	152	Using a Key.....	155
System	90	Types and Functions	149	Lockout prevention system.....	155
M (Sequential Shift Mode)	85	Won't turn	27	Low Battery Charge	587
Malfunction Indicator Lamp	83	Kickdown (Automatic Transmission)	389	Low Fuel Indicator.....	86
Parking Brake and Brake System (Red).....	82	L		Low Oil Level	105
Passenger Front Airbag On/Off.....	88	Lane Departure Warning	415	Low Oil Pressure Indicator	587
Rear Fog Light.....	92	Button	416	Lower Anchorages	71
Seat Belt Reminder.....	85	Indicator	97	Lubricant Specifications	
Security System Alarm.....	93	Language (HFT)	330, 355	Chart.....	609, 612, 615, 617
Shift Lever Position.....	84	Light Switches.....	174	Luggage (Load Limit)	375
Shift Up/Down	94	Lights.....	174, 514	Luggage Area	
Supplemental Restraint System	88	Automatic	175	Light Bulb.....	528
System Message	91	Bulb Replacement.....	514	Luggage Area Cover	213
Transmission	84	Daytime Running Lights.....	182	Luggage Hooks.....	210
Turn Signal	91	Fog Lights.....	177	Lumbar Support	194
VSA (Vehicle Stability Assist) system	89				
VSA OFF	89, 423				
Instrument Panel.....	81				
Brightness Control	187				
Interior Lights.....	202				

M

M (Sequential Shift Mode) Indicator.....	85
Maintenance.....	459
Battery.....	540
Brake/Clutch Fluid.....	510
Cleaning.....	549
Climate Control.....	546
Coolant.....	503, 506
Oil.....	498
Precautions.....	460
Radiator.....	505
Remote Transmitter.....	544
Replacing Light Bulbs.....	514
Safety.....	461
Transmission Fluid.....	508
Tyres.....	534
Under the Bonnet.....	490
Malfunction Indicator Lamp.....	83, 588
Manual Transmission.....	395
Map Lights.....	203
Maximum Permissible Weight.....	375
MENU Button.....	259
Meters, Gauges.....	119
Mirrors.....	190
Adjusting.....	190
Door.....	191
Exterior.....	191
Interior Rear View.....	190
Modifications (and Accessories).....	457
MP3.....	242, 250, 284, 290
MP3/WMA/AAC.....	284, 290

N

Numbers (Identification).....	619
-------------------------------	-----

O

Odometer.....	122
Oil (Engine).....	495, 497
Adding.....	502
Checking.....	498
Low Oil Level Indicator.....	105, 591
Low Oil Pressure Indicator.....	83, 587
Recommended Engine Oil.....	495, 497
Viscosity.....	495, 497
On Board Apps.....	297
Open Source Licences.....	312
Opening/Closing.....	
Bonnet.....	494
Power Windows.....	166
Sunshade.....	169
Tailgate.....	159
Outside Temperature Display.....	124
Overheating.....	583

P

Paddle Shifters (Sequential Shift Mode).....	21, 392
Parking Brake.....	430
Parking Brake and Brake System Indicator.....	588

Parking Brake and Brake System

Indicator (Red).....	82
Parking Sensor System.....	441
Passenger Front Airbag Off Indicator.....	59
Passing Indicators.....	174
Petrol.....	23, 452
Fuel Economy and CO ₂ Emissions.....	456
Gauge.....	119
Information.....	452
Instant Fuel Economy.....	123
Low Fuel Indicator.....	86
Refueling.....	452
PGM-FI Symbol.....	116, 591
Playing a video.....	295
Playing <i>Bluetooth</i> ® Audio.....	254, 293
+R Button.....	403
Precautions While Driving.....	
Rain.....	388
Pregnant Women.....	45
Puncture (Tyre).....	557

R

+R Button.....	403
Radiator.....	505
Radio.....	231, 277
Radio (AM/FM).....	231, 277
Radio (DAB).....	238, 281
Radio Data System (RDS).....	233, 279
RDS (Radio Data System).....	233, 279

Rear Demister/Heated Door Mirror			
Button	188		
Rear Fog Light Indicator	92		
Rear Seats (Folding Down)	199		
Rear Seats (Folding Up)	200		
Rear View Camera	451		
Rear View Mirror	190		
Refueling	452		
Diesel	453, 616		
Fuel Gauge	119		
Low Fuel Indicator	86		
Petrol	452, 608, 611, 614		
Regulations	622		
Remote Transmitter	152		
Replacement			
Battery	541		
Bulbs	514		
Fuses	592, 594, 595, 597		
Tyres	557		
Wiper Blade Rubber	530, 532		
Resetting a Trip Meter	122		
S			
Safe Driving	31		
Safety Check	35		
Safety Labels	80		
Safety Message	30		
Seat Belts	36		
Adjusting the Shoulder Anchor	44		
Checking	46		
Fastening	42		
Installing a Child Restraint System with a Lap/Shoulder Seat Belt	73		
Pregnant Women	45		
Reminder	39		
Warning Indicator	39, 85		
Seat Heaters	214		
Seats	193		
Adjusting	193		
Front Seats	193		
Rear Seats	199		
Seat Heaters	214		
Security System	162		
Immobilizer System Indicator	92		
Security System Alarm Indicator	93		
SEL/RESET Knob	122		
Select Lever	390, 395		
Operation	390, 395		
Releasing	582		
Won't Move	582		
Selecting a Child Restraint System	67		
Selector Knob (Audio)	229		
Sequential Shift Mode	392		
Setting the Clock	148		
Shift Lever	390, 395		
Shift Lever Position Indicator	84, 391		
Shift Up/Down Indicator	94		
Shifting (Transmission)	390, 395		
Shoulder Anchor	44		
Side Airbags	55		
Side Curtain Airbags	57		
Side Storage Compartment	210		
Side Support	194		
Siri Eyes Free	303		
Smartphone Connection	298		
Spare Tyre	557, 609, 612, 615, 617		
Spark Plugs	608, 611, 614		
Specifications	608		
Specified Fuel	452, 453		
Speed Limiter, Adjustable	407		
Speedometer	119		
SRS Airbags (Airbags)	50		
START/STOP Button	171		
Starting the Engine	382, 385		
Does Not Start	574		
Engine Switch Buzzer	170		
Jump Starting	578		
Steering Wheel			
Adjusting	189		
Stopping	440		
Super Locking	165		
Supplemental Restraint System (SRS)	50		
Switches (Around the Steering Wheel)	2, 3, 4, 170		
Synchronized Mode	217		
System Message Indicator	91		

- T**
- Tachometer 119
 - Tailgate
 - Opening/Closing 159
 - Unable to Open 601
 - Temperature
 - Outside Temperature Display 124
 - Temperature Sensor 124, 220
 - Temporary Repair Kit (TRK) 565
 - Time (Setting) 148
 - Tools 556
 - Towing a Trailer 376
 - Equipment and Accessories 378
 - Load Limits 376
 - Towing Your Vehicle
 - Emergency 599
 - Traffic Sign Recognition System 418
 - Small Icons On and Off 421
 - Transmission 390, 395
 - Automatic 389, 390
 - Fluid 508, 509
 - Gear Position Indicator 85
 - M (Sequential Shift Mode) Indicator 85
 - Manual 395
 - Sequential Shift Mode 392
 - Shift Lever Position Indicator 84, 391
 - Trip Meter 122
 - TRK (Temporary Repair Kit) 565
 - Troubleshooting 555
 - Blown Fuse 592, 594, 595, 597
 - Brake Pedal Vibrates 27
 - Buzzer Sounds When Opening Door 28
 - Emergency Towing 599
 - Engine Won't Start 574
 - Noise When Braking 28
 - Overheating 583
 - Puncture/Flat Tyre 557, 565
 - Rear Door Won't Open 27
 - Select Lever Won't Move 582
 - Warning Indicators 82
 - Turn signals 174
 - Indicators (Instrument Panel) 91
 - Tyres 534
 - Air Pressure 609, 612, 615, 617
 - Checking and Maintaining 534
 - Inspection 534
 - Puncture (Flat Tyre) 557
 - Rotation 537
 - Spare Tyre 557, 609, 612, 615, 617
 - Temporary Repair Kit (TRK) 565
 - Tyre Chains 538
 - Wear Indicators 535
 - Winter 538
- U**
- Ultrasonic Sensors 164
 - Under-Floor Storage Area 211
 - Unlocking the Doors 152
 - Unlocking the Front Doors from the
 - Inside 157
 - USB Flash Drives 250, 290, 310
 - USB Port 223
- V**
- Vanity Mirrors 7
 - Vehicle Identification Numbers 619
 - Vehicle Stability Assist (VSA) 422
 - Ventilation 215, 218
 - Viscosity (Oil) 495, 497, 609, 612, 615, 617
 - VSA (Vehicle Stability Assist) 422
 - OFF Indicator 89
 - Off Switch 423
 - System Indicator 89
- W**
- Wallpaper 142, 262
 - Warning and Information Messages 103
 - Warning Indicator On/Blinking 587
 - Warning Labels 80
 - Watts 608, 611, 614, 616
 - WAV 290
 - Wear Indicators (Tyre) 535
 - Wheel Nut Wrench (Jack Handle) 562
 - Wi-Fi Connection 301
 - Window Washers
 - Adding/Refilling Fluid 511
 - Switch 183
 - Windows (Opening and Closing) 166

Windscreen	
Cleaning	552
Defrosting/Defogging	216, 219
Washer Fluid	511
Wiper Blades	530
Wipers and Washers	183
Winter Tyres	
Tyre Chains	538
Wipers and Washers	183
Checking and Replacing Wiper Blades.....	530
WMA	242, 250, 284, 290
Worn Tyres	534

